



[Type text]



# مقرر

## **INSTRUCTIONAL PSYCHOLOGY**

**Third GE**

**Faculty of Education**

الفرقة ..... الثالثة شعبة... التعليم العام برنامج اللغة

أستاذ المقرر

أ.د/ حجاج غانم : قسم علم النفس التربوي



[Type text]  
كلية التربية بالغردقة



العام الجامعي

2022 / م 2023

## بيانات أساسية

**الكلية:** التربية

**الفرقة:** الثالثة

**التخصص:** تعليم عام برنامج اللغة: جميع الشعب

**عدد الصفحات:**

**القسم التابع له المقرر:** قسم علم النفس التربوي

[Typ



[Type text]



فيديو للمشاهدة.



والدراسة. للقراءة نص



رابط خارجي.



أسئلة للتفكير والتقييم الذاتي.



أنشطة ومهام.

تواصل عبر مؤتمر الفيديو.

[Typ



[Type text]



# Instructional Psychology

## محتوي الكتاب

	page
Ch.1 Introduction in Educational Psychology	6
Ch.2 THEORIES OF LEARNING	42
Ch.3	55

[Typ



[Type text]



Theoretical Perspective of Learning	
Ch. 4	79
To write learning theories	

11	Video 1: Educational Psychology Definition
17	Video 2 : Education vs Schooling
30	Video 3 : Experimental Method
44	Video 4 : Language Psychology
70	Video 5 : Pavlov Theory

[Typ



[Type text]



## Unit 1: Introduction to Educational Psychology (Handout I)

### What is Psychology?

The word, 'Psychology' is derived from two Greek words, 'Psyche' and 'Logos'. Psyche means 'soul' and 'Logos' means 'science'. Thus psychology was first defined as the 'science of soul'.

**Psychology as the Science of Soul.** In ancient days, the Greek philosophers like Plato and Aristotle interpreted Psychology as the science of the soul and studied it as a branch of Philosophy. But soul is something metaphysical. It cannot be seen, observed and touched and we cannot make scientific experiments on soul.

**Psychology as the Science of the Mind.** It was the German philosopher Emmanuel Kant who defined Psychology as the science of the mind. William James (1892) defined psychology as the science of mental processes. But the word 'mind' is also quite ambiguous as there was confusion regarding the nature and functions of mind.

**Psychology as the Science of Consciousness.** Modern psychologists defined psychology as the "Science of Consciousness". James Sully (1884) defined psychology as the "Science of the Inner World". Wilhelm Wundt (1892) defined psychology as the science which studies the "internal experiences". But there are three levels of consciousness – conscious, subconscious and the unconscious and so this definition also was not accepted by some.

**Psychology as the Science of Behaviour.** At the beginning of the 20<sup>th</sup> century, when psychologists attempted to develop psychology into a pure science, it came to be defined as the science of behaviour. The term behaviour was popularized by J.B. Watson. Other exponents are William McDugall and W.B. Pillsbury. According to R.S. Woodworth, "First Psychology lost its soul, then it lost its mind, then lost its consciousness. It still has behaviour of a sort."

### Definitions of Psychology

B.F. Skinner defined, "Psychology is the science of behaviour and experience." Crow and Crow, "Psychology is the study of human behaviour and human relationships." William Mc Dougall, "Psychology is the science which aims to give us better understanding and control of





## 2 Educational Psychology

the behaviour of the organism as a whole.” Kurt Koffka, “Psychology is the scientific study of the behaviour of living creatures in their contact with the outer world.”

### **Meaning of Educational Psychology**

Educational psychology is one of the branches of psychology to study the behaviour of the learner in relation to his education. As specialized branch of psychology concerns itself with suggesting ways and means of improving the process and products of education, enabling the teacher to teach effectively and the learners to learn effectively with the minimum effort.

It is thus designated as the service of education. It has simplified the tasks and improved the efficiency of the teacher or all those connected in the process and products of education by supplying them with the essential knowledge and skills in much need the same way as science and technology has helped in making possible maximum output through minimum input in terms of time and labour in our day-to-day activities.

Educational psychology is that branch of psychology which deals with the application of psychological findings in the field of education. In other words it deals with the human behaviour in educational situations. It is the systematic study of the development of the individual in the educational settings.

It is the scientific study of human behaviour by which it can be understood, predicated and directed by education to achieve goals of life.

### Definitions of Educational Psychology

- **C.E. Skinner:** “Educational psychology is the branch of psychology which deals with teaching and learning”.
- **Crow and Crow:** “Educational psychology describes and explains learning experience of an individual from birth to old age”.
- **E. A. Peel:** “Educational psychology is the science of education”.
- **Trow** describes, “Educational psychology is the study of psychological aspects of educational situations”.
- **Stephens** says, “Educational psychology is the study of educational growth and development”.
- **Judd** describes educational psychology as, “a scientific study of the life stages in the development of an individual from the time he is born until he becomes an adult.”

In the words of **E.A. Peel**, “Educational psychology helps the teacher to understand the development of his pupils, the range and limits of their capacities, the processes by which they learn and their social relationships.”



<https://www.youtube.com/watch?v=fGPoKuVgj2w>

[Typ



[Type text]

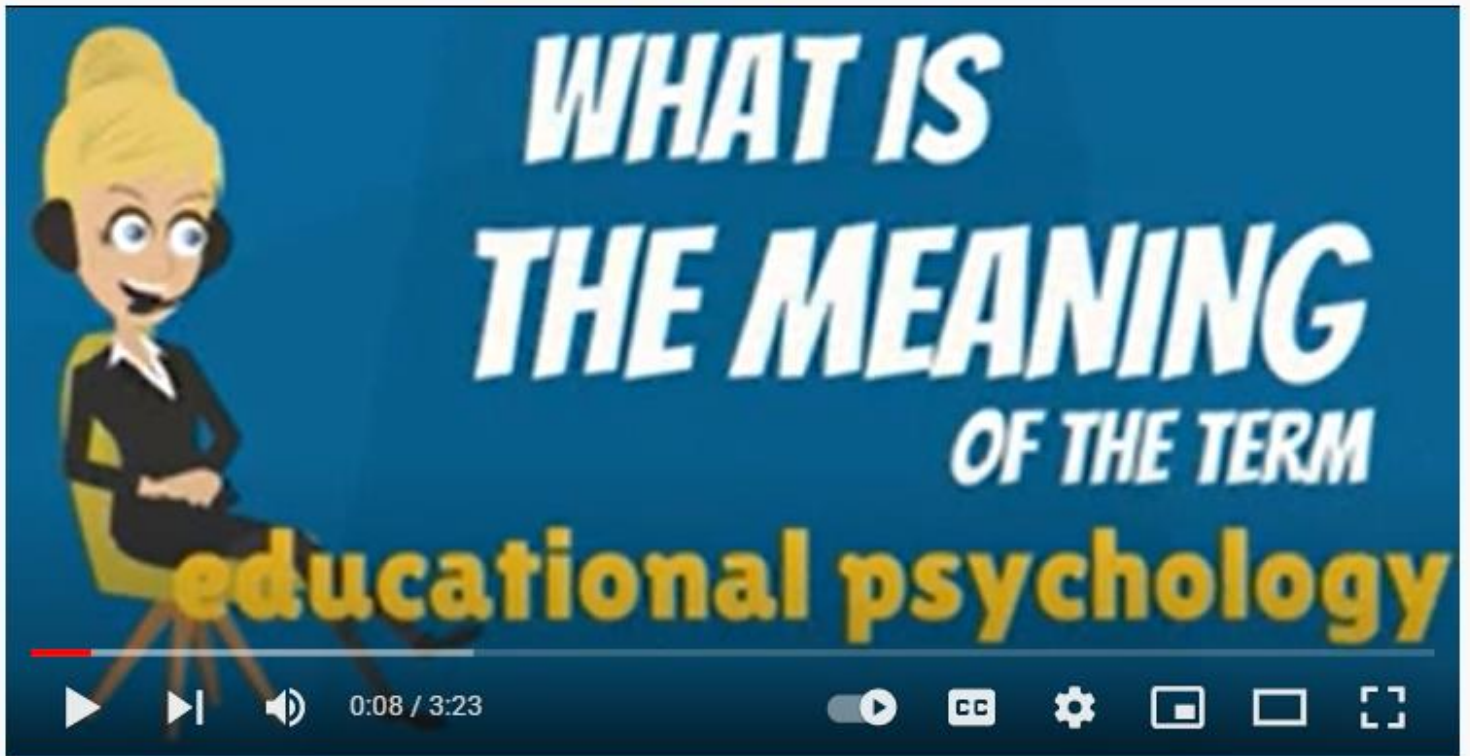

### 3 Educational Psychology

(In this way, the work of the Educational Psychologist resembles with that of an Engineer, who is a technical expert. The Engineer supplies all the knowledge and skill essential for the accomplishment of the job satisfactorily... for example, construction of a bridge.). In the same way Educational Psychologists, who is a technical expert in the field of Education, supplies all the information, principles and techniques essential for:

- Understanding the behaviour of the pupil in response to educational environment and
- Desired modification of his behaviour to bring an all-round development of his personality.

Thus, Educational Psychology concerned primarily with understanding the processes of teaching and learning that take place within formal environments and developing ways of improving those methods. It covers important topics like learning theories; teaching methods; motivation; cognitive, emotional, and moral development; and parent-child relationships etc.

In short, it is the scientific discipline that addresses the questions: “Why do some students learn more than others?” and “What can be done to improve that learning?”



<https://blog.learnfasthq.com/9-tips-to-improve-how-you-learn-your-learning-capacity>

## The Nature of Educational Psychology:

Its nature is scientific as it has been accepted that it is a Science of Education. We can summarize the nature of Educational Psychology in the following ways:

1. **Educational Psychology is a science.** (Science is a branch of study concerned with observation of facts and establishment of verifiable general laws. Science employs certain objective methods for the collection of data. It has its objectives of understanding, explaining, predicting and control of facts.) Like any other science, educational psychology has also developed objective methods of collection of data. It also aims at understanding, predicting and controlling human behaviour.
2. **Educational Psychology is a natural science.** An educational psychologist conducts his investigations, gathers his data and reaches his conclusions in exactly the same manner as physicist or the biologist.
3. **Educational psychology is a social science.** Like the sociologist, anthropologist, economist or political scientist, the educational psychologist studies human beings and their sociability.
4. **Educational psychology is a positive science.** Normative science like Logic or Ethics deals with facts as they ought to be. A positive science deals with facts as they are or as they operate. Educational psychology studies the child's behaviour as it is, not, as it ought to be. So it is a positive science.
5. **Educational psychology is an applied science.** It is the application of psychological principles in the field of education. By applying the principles and techniques of psychology, it tries to study the behaviour and experiences of the pupils. As a branch of psychology it is

#### 4 Educational Psychology

parallel to any other applied psychology. For example, educational psychology draws heavily facts from such areas as developmental psychology, clinical psychology, abnormal psychology and social psychology.

**6. Educational psychology is a developing or growing science.** It is concerned with new and ever new researches. As research findings accumulate, educational psychologists get better insight into the child's nature and behaviour.

Thus, educational psychology is an applied, positive, social, specific and practical science. While general science deals with behaviour of the individuals in various spheres, educational psychology studies the behaviour of the individual in educational sphere only.

#### **Nature of Educational psychology as scientific because:**

The nature of educational psychology is regarded as scientific because it is organized, systematic and universally accepted body, wherein the facts remain constantly in search of truth through research and experimentation. Employs scientific methods in its study and its results are subjected to further verification and modification.

1. **Laws of educational psychology are universal:** Educational psychology possesses a well-organized, systematic and universally accepted body of facts supported by the relevant psychological laws and principles.
2. **Scientific methods:** Educational psychology employs scientific methods and adopts a scientific approach for studying the learner's behaviour such as observation, experimentation, clinical investigation and generalization, etc.
3. **Constant search of the truth:** The results of any study in educational psychology can be challenged and are modified or altered in terms of the latest explanations and findings. So the findings of any study are never taken as absolute and permanent.
4. **Reliability:** Educational psychology does not accept hearsay and not take anything for granted. It emphasizes that essentially there is some definite causes linked with a behaviour and the causes of this behaviour are not related to supernatural phenomena.
5. **Positive science:** Educational psychology is a positive science rather than a normative science.
6. **Applied behavioural science:** Educational psychology is an applied/behavioural science.
7. **Developing positive science:** Educational psychology cannot claim the status of a developed positive science like other natural or applied sciences. It is considered as one of the developing positive sciences of the learner's behaviour.

## 5 Educational Psychology

### **Objectives of Educational Psychology:**

The general objectives of educational psychology are:

1. To provide a body of facts and methods which can be used in solving teaching problems.
2. To develop a scientific and problem-solving attitude.
3. To train in thinking psychologically about educational problems.

### **Education vs Schooling**

Even though schooling is frequently misidentified as education, there is much difference between education and schooling. The term education encompasses basically two meanings. They are formal and informal ways of gaining knowledge while schooling stands for the initial and secondary stage of formal education system that take place in school. Education as mentioned above can take place not only through informal ways such as learning from peers, life experiences, by reading or learning things through online sources but also through formal means. For instance, through educational institutions like school, university or even training colleges. Thus, it becomes clear schooling is one branch of formal education in the wide arena of education.



<https://www.youtube.com/watch?v=53siPqzCoDE>



[Typ



[Type text]



# FINDING EVIDENCE BASED SOLUTIONS



0:02 / 5:24



Education vs Schooling

### Teaching Objectives of Educational Psychology:

1. To develop an understanding and appreciation of the dietary and environmental factors which underline learning ability.
2. To provide base for understanding the nature and principles of learning and to supply the techniques for its improvement.
3. To understand and appreciated factors influencing individual ability to learn.
4. To provide understanding of the external factors like training aids, libraries, classrooms which are largely within the control of the teacher and the institution.
5. To evaluate teaching efficiency.
6. To develop an appreciation of the individual and importance of the individual with their individual differences.

### Scope of Educational Psychology:

Scope of educational psychology tells us the areas of application. In other words, it can be called the subject matter of educational psychology.

1. **Human Behaviour.** It studies human behaviour in the educational context. Psychology is the study of behaviour and education aims at modification of behaviour. Hence the influence of Educational Psychology has to be reflected in all aspects of education.



What are the other variables which Educational Psychology concern ?

## 6 Educational Psychology

2. **Growth and development.** It studies the principles governing growth and development. The insight provided by the study will help in scientifically planning and executing learner oriented programmes of education.
3. **The Learner.** The subject-matter of educational psychology is knitted around the learner. Therefore, the need of knowing the learner and the techniques of knowing him well. The topics include – the innate abilities and capacities of the individuals, individual differences and their measurements, the overt, covert, conscious as well as unconscious behaviour of the learner, the characteristics of his growth and development and each stage beginning from childhood to adulthood.
4. **The Learning Experiences.** Educational Psychology helps in deciding what learning experiences are desirable, at what stage of the growth and development of the learner, so that these experiences can be acquired with a greater ease and satisfaction.
5. **Learning process:** After knowing the learner and deciding what learning experiences are to be provided, Educational Psychology moves on to the laws, principles and theories of learning. Other items in the learning process are remembering and forgetting, perceiving, concept formation, thinking and reasoning, problem solving, transfer of learning, ways and means of effective learning etc.
6. **Learning Situation or Environment.** Here we deal with the environmental factors and learning situations which come midway between the learner and the teacher. Topics like classroom climate and group dynamics, techniques and aids that facilitate learning and evaluation, techniques and practices, guidance and counselling etc. For the smooth functioning of the teaching-learning process.



What are the differences between the moderator and mediator variables ?



7. **Evaluation of learning process:** Some forms of evaluation inevitable in teaching. Also in all fields of activity when judgments used to be made, evaluation plays an important role. Even when we want to cross a road we make a judgment whether it is safe to cross the road. Effectiveness of learning process always depends on the evaluation as it gives the knowledge of result which helps the learner as well as the teacher to modify or correct oneself. Educational psychology guides are by explaining the different methods of assessment contributing to the effectiveness of learning process. Knowing the learner, acquiring the essential skill in teaching and evaluation are the focal points in the study of educational psychology.
8. **Individual differences.** It is universally accepted that every individual differs from every other individual. This idea has been brought to light by Educational Psychology.
9. **Personality and adjustment.** Education has been defined as the all-round development of the personality of an individual. If educational has to fulfil this function all instructional programmes have to be based on the principles governing the nature and development of personality.
10. **The Teacher:** The teacher is a potent force is any scheme of teaching and learning process. It discusses the role of the teacher. It emphasizes the need of 'knowing thyself' for a teacher to play his role properly in the process of education. His conflicts, motivation. Anxiety, adjustment, level of aspiration etc. It throws light on the essential personality traits, interests, aptitudes, the characteristics of effective teaching etc. so as to inspire him for becoming a successful teacher.

## 7 Educational Psychology

**11. Guidance and Counselling.** Education is nothing by providing guidance and counselling required for the proper development of the child. This is very true, especially in the light of the extremely complex and problematic situation one has to face in the fast growing world. Educational psychology has come to the rescue by developing principles and practical measures helpful for providing effective guidance and counselling.

We can conclude by saying that Educational Psychology is narrower in scope than general psychology. While general psychology deals with the behaviour of the individual in a general way, educational psychology is concerned with the behaviour of the learner in an educational setting.

### **Relevance Of Educational Psychology For Teachers**

Educational psychology has contributed considerably to the creation of the modern system of education. The knowledge of educational psychology helps the teacher in the following ways:

1. **To understand the Stages of Development:** Psychology has clearly shown that human life passes through different stages of development before it reaches adulthood. They are infancy, childhood, adolescence and adulthood. Psychologists have also thoroughly studied the characteristic behaviour patterns in these different periods of life. Identification of these periods with different sets of characteristics and attributes as regards physical, mental and emotional development greatly help educationists to design curriculum and determine appropriate methods of teaching for students at different stages.

2. **To Know the Learner:** The child or the learner is the key factor in the teaching-learning process. Educational psychology helps the teacher to know his interests, attitudes, aptitudes and the other acquired or innate capacities and abilities; to know the stage of development linked with his social, emotional, intellectual, physical and aesthetic needs; to know his level of aspiration, his conscious and unconscious behaviour; his motivational and group behaviour; his conflicts, desires and other aspects of his mental health. So that perfect guidance and help can be provided and positive attitude towards the learner can be formed.

3. **To Understand the Nature of Classroom Learning:** Educational Psychology helps the teacher to adapt and adjust his teaching according to the level of the learners. A teacher is teaching in a class but a large number of students do not understand the subject-matter which is being taught. To deal with the students effectively in the class the teacher must have the knowledge of the various approaches to the learning process, principles, laws and factors affecting it then only he/she can apply remedial measures in the learning situation.

4. **To Understand the Individual Differences:** No two persons are exactly alike. Pupils differ in their level of intelligence, aptitudes, likes and dislikes and in other propensities and potentialities. There are gifted, backward, physically and mentally challenged children. Thus, psychology tells the teacher about the individual differences among the students in the class and the procedure, methodology and techniques to be adopted for them.

5. **To Solve Classroom Problems:** There are innumerable problems like truancy, bullying, peer pressure, ethnic tensions, cheating in tests etc. Educational Psychology helps to equip the

## 8 Educational Psychology

teacher by studying the characteristics of the problem children, the dynamics of the group, behavioural characteristics and adjustments.

**6. To develop Necessary Skills and Interest in Teaching:** Educational psychology helps the teacher to acquire and develop necessary qualities and skills to deal with the problems created by the pupils, maintain a healthy atmosphere in the classroom and show concern regarding the progress of the child.

**7. To Understand Effective Methods of Teaching:** Educational Psychology has discovered several new approaches, principles, methods and techniques of teaching which are very helpful in today's teaching-learning process. Educational psychology tells us how significant play and recreation are for the children and how play-way methods turn learning into an interesting task.

**8. To Understand the Influence of Heredity and Environment on the Child:** Educational psychology helps the teacher to know that the child is the product of heredity and environment. They are the two sides of a coin. Both play a prominent part in the all-round development of the child. While the child is born with a number of hereditary qualities, environment helps them to be modified according to the requirements of the society.

**9. To Understand the Mental Health of the Child:** Educational Psychology helps the teacher to know what are the factors responsible for the mental ill-health and maladjustment of a student and to suggest improvement thereof. Besides this, it also provides the teacher with necessary insight to improve his own mental status to cope up with the situation.



Search about one paper which studied the influence of Heredity on the child ?

**10. To Understand the Procedure of Curriculum Construction:** Curriculum is an integral part of the teaching-learning process. Curriculum should be child-centred and fulfil the motives and psychological needs of the individual because child capacities differ from stage to stage. Educational psychology helps the teacher to suggest ways and means to curriculum framers to prepare sound and balanced curriculum for the children.

**11. To Provide Guidance and Counselling:** Today guidance to a child at every stage of life is needed because psychological abilities, interests and learning styles differ from person to person. Similarly, what courses of study the child should undertake in future is also a vital question. All these can be answered well if the teacher knows the psychology of children.

**12. To Understand Principles of Evaluation and Assessment:** Evaluation is an integral part of the teaching-learning process. How to test the potentialities of the child depends upon the evaluation techniques. The development of the different types of psychological tests for the evaluation of the individual is a distinct contribution of educational psychology.

**13. To inculcate Positive and Creative Discipline:** The slogan of the traditional teachers was “spare the rod and spoil the child.” Flogging the child was the chief instrument. Educational Psychology has replaced the repressive system with the preventive system. Now teachers adopt a cooperative and scientific approach to modify the behaviour of the students. Emphasis is laid on self-discipline through creative and constructive activities.

**14. Educational Psychology and Research:** Educational psychologists conduct research to improve the behaviour of human beings in the educational situation. For this purpose it helps in developing tools and devices to measure the performance and suggest remedial measures thereof.

**15. To Know Himself/Herself:** Educational Psychology helps the teacher to know about himself/herself. His/her own behaviour pattern, personality characteristics, likes and dislikes,



## 9 Educational Psychology

motivation, anxiety, conflicts, adjustment etc. All this knowledge helps him in growing as a successful teacher.

**16. Educational Psychology Helps in Professional Growth, Changing Attitude and Innovative Thinking:** Inside the classroom, educational psychology has enabled the teacher to achieve proper conditioning of pupils by achieving and directing classroom programmes on human lives. Not only this, educational psychologists are busy in finding out innovations in the field of education. These innovations will bring about professional growth of the teacher.

In **Conclusion**, we can say that educational psychology has contributed considerably to the creation of the modern system of education. In teaching, we are dealing with three elements – the teacher, the student, and the subject. It has helped teachers, headmasters, administrators, inspectors, guidance and counselling workers, social workers to significantly develop an impartial and sympathetic attitude towards children and form them into integrated personalities.



## Methods

Educational psychology like any other science, makes use of scientific methods in collecting data about learner, learning process and evaluation.

1. To get facts about learning behaviour rather than opinions.
2. To get good information so that the learner can be guided.

Educational psychology as a science of education deals with the problems of teaching and learning and helps the teacher in his task of modifying the learners behaviour and bringing about an all-round development of his personality.

Therefore, while in psychology the scope of study and the field of operation are extended to cover the behaviour of all living organisms related to all their life activities in educational psychology, the scope of such behavioural study is limited within the confines of the teaching, learning processes, i.e. studying the behaviour of the learners in relation to their educational environment and the all-round development of their personality.

Thus the subject of educational psychology must be centred around the process of teaching and learning for enabling the teacher and learner to do their jobs as satisfactory as possible. Thus educational psychology definitely covers the topics helpful in suggesting principles and techniques for the selection of the learning experience appropriate to each developmental stage of the childhood.

## 10 Educational Psychology

Hence it includes the study of the behavior of the learner in the educational environment. It also includes the topics and content which are specifically meant for improving the process and products of education mainly centred around the teaching learning process.

Therefore, this study includes:

1. In knowing the learner.
2. Enabling the teacher to know their self-strengths, limitations and to acquire essential teaching skills.
3. Selection and organization of proper learning.
4. Experiences suited to the individuality and developmental stages of the learner.
5. Suggesting suitable methods and techniques for providing the desired learning experience.
6. In arranging proper learner situation.

[Typ



[Type text]



## Methods of Educational Psychology:

Educational psychology is the scientific or systematic study of the behaviour of the learner in relation to his educational environment. This behaviour can be studied by a simple approach called observation. However, this observation method has to be adjusted depending upon the conditions in which observations have to be made, the procedure and tools adopted.

The following are the various methods of observation under different situations:

**1. Introspection method:** This method which is the oldest method of studying behaviour where the learner should make a self-observation, i.e. looking inwards. For example, when a person is angry he may be asked to determine how he felt during that period of anger by his own observation.

This method is simple, direct, cheap and reveals one's behaviour. But this method lacks reliability and can be used only for adult normal human beings. This method requires the support of other methods which are more reliable.

**2. Observation method:** In this method the learner's behaviour is observed under natural conditions by other individuals. Such observation will be interpreted according to the perception of the observer. This helps to find out behaviour by observing a person's external behaviour.

For example, if a person frowns we can say that he is angry. But when we are studying behaviour in natural conditions we have to wait for the event to take place. This method is helpful in studying the behaviour of the children. However, this method will explain only observed behaviour, subjectivity of the investigation may affect the results.

**3. Experimental method:** In this method, behaviour is observed and recorded under controlled conditions. This is done in psychological laboratory or in classrooms or outside the classrooms



[Typ



[Type text]



<https://www.youtube.com/watch?v=B2GcTIJYIZI>

The image shows a YouTube video player interface. The video title is "Experimental Method". The video content displays the text "EXPERIMENTAL METHOD" in large, bold, blue letters. To the right of the text is an illustration of a laboratory flask containing a green liquid with bubbles rising from it. The video player controls at the bottom include a play button, a progress bar showing 0:40 / 6:32, a volume icon, a play/pause button, a CC icon, a settings gear, a full screen icon, and a share icon.

Experimental Method

## 11 Educational Psychology

in certain physical or social environment. Accordingly the cause and effect relationships are established.

Theories of behaviour can be developed. These experiments require the creation of artificial environment. Therefore, the scope is limited. Human behaviour is very dynamic and unpredictable. This method is also costly and time consuming.

**4. Case history method:** This method is one of the steps used in the clinical method of studying behaviour. This method is used for those who are suffering from physical or mental disorders. For this the case history has to be made of the earlier experiences of the individual which may be responsible for the present behaviour. Information is also collected from his parents, family, relatives, guardians, neighbours, friends, teachers, and from reports about the individual's past. This information will enable the clinical psychologists to diagnose and suggest treatment if there is any problem. However, this method will be successful only if the clinical researcher is technically efficient. The findings are limited to the individuals observed and the findings cannot be generalized.

### **Relationship Between Education and Psychology**

Psychology is closely related to education. Education is the modification of behaviour in a desirable direction or in a controlled environment and psychology is the study of behaviour or science of behaviour. To modify the behaviour or to bring about some changes in the behaviour it is necessary to study the science of behaviour. Thus, education and psychology are logically related.



The developmental stages of children and characteristics are very essential factors which the teacher must know in order to be a successful teacher. The traditional education was subject centred and teacher dominated. But the modern concept of education has been changed into learning centred to learner centred.

**Today's education has become child centred:**

It is the child who is to learn according to his needs, interests and capacities. Hence, there is no doubt that a knowledge of psychology is quite essential for planning and organizing any educative effort. For this purpose all the great educators emphasize that education must have a psychological base.

Pestalozzi tried to psychologise education. Montessori and Froebel also advocated that education must be based on psychological principles. Almost all the aspects of education are guided by psychological principles.

**Different aspects of education related to psychological principles are as follows:**

1. The objectives of education at different stages have a psychological base.



## 12 Educational Psychology

2. Preparation of curriculum for different stages as per the age, ability and capacities of the learner must be based on some of the psychological principles.
3. The teacher employs some of the suitable methods of teaching, appropriate motivational techniques and teaching devices which are also the contributions of educational psychology.
4. Solution of different educational problems through research are also the contribution.
5. Preparation of school time table and timing have also a psychological base.
6. Effective school administration and organization needs a knowledge of psychology.
7. Knowledge of psychology is necessary to study the gifted or the retarded child, the problem child and the maladjusted child.
8. The problem of discipline in the school can be tackled psychologically.
9. Educational psychology provides knowledge about mental health of the teacher.
10. Psychology provides knowledge about evaluation procedure for better learning in the school.
11. Better guidance can be provided for effective learning by studying the psychological traits of the learner.

Besides the above, better students participation in classroom teaching, individualized instruction, group activity, learning by doing etc. has a psychological base. So, we cannot think of education without psychology in modern education scenario.



### **A Brief History**

According to the modern definition of psychology, mind can be analysed functionally into different mental processes—cognitive, conative and emotive and is expressed through behaviour of the interacting person. Hence psychology is a science of behaviour.

Psychology emerged as a scientific discipline as and when Wilhelm Wundt—the founder of experimental psychology— established the first psychological laboratory at Leipzig in Germany in the year 1879. From that time onward the learned world witnessed a host of renowned psychologists working in different aspects of mental performances and a long intellectual pursuit of psychological discoveries ensued.

This led more and more to the application of theories, branching, specialization, specification of methods as well as more and more qualitative and quantitative sophistication of techniques. One such branching encompasses the educational field and has been termed as Educational Psychology which emerged as a separate discipline, involving the general principles of experimental psychology applied in the field of education.

A great name in the history of educational thoughts in the early 19th century was Pestalozzi who psychologised education by emphasizing upon ‘education’ as a process of drawing out the functional mind of the individual.

### 13 Educational Psychology

The next great advance in educational psychology came about mid-nineteenth century when Johann Frederich Herbart, a German professor, formulated an approach to education based directly and avowedly upon psychology.

From the end part of nineteenth century till the beginning of twentieth century a number of famous psychologists started working in different lines of education applying the principles and techniques of general psychology. Among them mention may be made of Francis Galton, the oldest of the founders of educational psychology.

He conducted the first experimental investigation of associationism, tests on reaction time and sensory acuity. Stanley Hall, meanwhile, published his papers using the questionnaire to investigate the minds of children. In 1885, Ebbinghaus published his study on memory and, within the span of six years, events of importance like objective measurement, child psychology and learning experiments, all took place.

To add to the list enriching the movement was Galton's studies on nature-nurture problem, mental inheritance of ability, studies of twins, widespread realizations of individual differences in the psychological sense, various mental and physical developments as well as use of psychological tests and their statistical interpretation (particularly the correlational studies which was later followed by Karl Pearson), rating scales and questionnaires. "His most important theoretical contribution was the distinction in the 'Structure of mind' between a general broad ability of intelligence and special abilities entering only into narrower ranges of activity".

The next major contributor to the foundation of educational psychology was Alfred Binet in the field of intelligence testing. With assistance of Theophile Simon, he developed the first Binet Scale. Then comes John Dewey whose contribution is rather noteworthy in the field of educational philosophy than in the general psychological field.

After Dewey, from the year 1900 to some ten or twelve years more, educational psychology remained more or less in incubation till Edward L. Thorndike came out with his revolutionary 'laws of learning'.

He was possibly the first man to be called an educational psychologist in the modern sense of the term. He studied the art and science of learning very systematically and consistently. Then joined Woodworth with Thorndike and together they worked on transfer of training at the turn of the century.

Thorndike then published three volumes of Educational Psychology between 1913-14 consisting of his original work arising from experimental research. His studies in various

## 14 Educational Psychology

related fields of education opened up new vistas to be trekked by later educational psychologists.

### **More about Educational Psychology's Scope**

Educational psychology embraced over the years various fields of education e.g. intelligence testing, mental abilities, achievement testing, child psychology, developmental psychology, school performance, mental deficiency, curriculum, personality, character, educational measurement and so on and so forth.

In 1910, the Journal of Educational Psychology was first published, to reveal experimental researches on various psychological issues regarding education and their interpretations.

In the recent past the field of educational psychology has become more complex as the vision of what it encompasses has broadened. Originally concerned with learning and measurement its scope has been extended with each succeeding generation to the point where now the newest extension is in social-educational field and a new branch emerged in educational psychology known as educational social psychology.



Can you find the first issues in the Journal of Educational Psychology ?

In conclusion, we may note that the aim of educational psychology is to apply psychological concepts and principles in order to improve educational practice. Educational psychology that has evolved as a new discipline tends to represent all the areas within psychology in general.

These include some distinct areas dealing with human development, individual difference in ability, aptitude and temperament, perception, motivation, learning, thinking, problem-solving, psychopathology, the dynamics of personality and group interactional processes.

The educational scientists have employed two strategies for applying psychology in education. Consequently, two kinds of researches had been advanced in the field of educational psychology; the first is the direct experimental investigation of learning in laboratory and school settings.

The second has been an attempt to distil from basic psychological research the educational proceedings to be employed in teaching-learning situation, implication of learning in its broader perspective (formal and informal learning), and also human nature and its interactions.

In this process educational psychology deals not only with the individual's own psychology and its functioning, but also an awareness of his interacting counterpart, the changing environment—both physical and social.

## 15 Educational Psychology

Any educational endeavour is actually a learning situation; the task of educational psychology is to study the learner in that situation. The first learning situation outside the family a child (or a learner) encounters is the school, which is again teaching-learning condition oriented. The teacher's duty in this setting is to apply the general propositions received from psychology and apply them in the classroom.

But not one single strategy employed so far had yielded any fruitful result. A more practical oriented strategy is required in order to synthesize the learner, the teacher the instructional techniques and the educational managers on the one hand and producing qualified students to meet the demand of the day, on the other.

The world we live in today is shaped to a considerable degree by the decisions people make—individually and collectively. Any decision-making needs possessing some knowledge and use them in solving problems. In other words, the kind of perceiving, thinking and evaluating that goes into the problem solving has to be considered.

Historically, possession of knowledge and its utilization are learned during the developmental years of the children through interacting with parents, employers, religious and political leaders as well as teachers in the classroom.

The interaction with the teachers is no less important in the process of our lifelong learning even if the exposure to school be brief and transitory (this is stated considering the number of dropouts at the school level in our country). It has an impact in their lives, nevertheless.

Specially in the developing countries like India and South Asia the involvement of young people with teachers and schools is certainly increasing as revealed by survey reports at Governmental level for the last two decades. Teachers do play an active role in the teaching-learning system.

It will not be unreasonable to say that the kind of future we and our children will experience is influenced more by teachers than by any other professional groups.

The world of tomorrow will be shaped not only by what today's children are learning from their teachers, but also by the 'way' they are learning it, for it is the way knowledge is presented that determines how children will learn to solve problems. Thus according to Lindgren (1980), the 'how' of teaching includes not only teaching methods, but also teachers' attitudes and values, and full range of teachers' classroom behaviours.

They serve as 'models' whose way of thinking, behaving, attitudes, advice and manner, the process of acquiring and imparting knowledge are imitated in more ways than they can



[Typ



[Type text]



## 16 Educational Psychology

imagine. Hence they are influential far beyond their immediate awareness. Therefore, it is necessary that the teachers know consciously their personal psychology in order to understand the psychology of their students.

## Unit 2



### **THEORIES OF LEARNING**

#### **2. BEHAVIORIST THEORIES**

##### **2.1. Behaviorism Overview**

Behaviorism is an approach to psychology that combines elements of philosophy, methodology, and theory. It emerged in the early twentieth century as a reaction to mentalistic psychology, which often had difficulty making predictions that could be tested using rigorous experimental methods. The primary tenet of behaviorism, as expressed in the writings of John B. Watson, B. F. Skinner, and others, is that psychology should concern itself with the observable behavior of people and animals, not with unobservable events that take place in their minds. The behaviorist school of thought maintains that behaviors as such can be described scientifically without recourse either to internal physiological events or to hypothetical constructs such as thoughts and beliefs. From early psychology in the 19th century, the behaviorist school of thought ran concurrently and shared commonalities with the psychoanalytic and Gestalt movements in psychology into the 20th century; but also differed from the mental philosophy of the Gestalt psychologists in critical ways. Its main influences were Ivan Pavlov, who investigated classical conditioning although he did not necessarily agree with behaviorism or behaviorists, Edward Lee Thorndike, John B. Watson who rejected introspective methods and sought to restrict psychology to experimental methods, and B.F. Skinner who conducted research on operant conditioning.

In the second half of the 20th century, behaviorism was largely eclipsed as a result of the cognitive revolution. While behaviorism and cognitive schools of psychological thought may not agree theoretically, they have complemented each other in practical therapeutic applications, such as in cognitive–behavioral therapy that has demonstrable utility in treating certain pathologies, such as simple phobias, PTSD, and addiction. In addition, behaviorism sought to create a comprehensive model of the stream of behavior from the birth of a human to their death. Behaviorism focuses on one particular view of learning: a change in external behavior achieved through a large amount of repetition of desired actions, the reward of good habits and the discouragement of bad habits. In the classroom this view of learning led to a great deal of repetitive actions, praise for correct outcomes and immediate correction of mistakes. In the field of language learning



<https://www.youtube.com/watch?v=DtJLMcjpLU8>

[Typ



[Type text]



# Language



0:03 / 5:26 • Chapters >         

Language | Psychology

this type of teaching was called the audio-lingual method, characterized by the whole class using choral chanting of key phrases, dialogues and immediate correction.

## 2.2. Classical Conditioning

Classical conditioning (also Pavlovian conditioning or respondent conditioning) is a kind of learning that occurs when a conditioned stimulus (CS) is paired with an unconditioned stimulus (US). Usually, the CS is a neutral stimulus (e.g., the sound of a tuning fork), the US is biologically potent (e.g., the taste of food) and the unconditioned response (UR) to the US is an unlearned reflex response (e.g., salivation). After pairing is repeated (some learning may occur already after only one pairing), the organism exhibits a conditioned response (CR) to the CS when the CS is presented alone. The CR is usually similar to the UR, but unlike the UR, it must be acquired through experience and is relatively impermanent. Classical conditioning differs from operant or instrumental conditioning, in which a behavior is strengthened or weakened, depending on its consequences (i.e., reward or punishment).

A classic experiment by Pavlov exemplifies the standard procedure used in classical conditioning. First Pavlov observed the UR (salivation) produced when meat powder (US) was placed in the dog's mouth. He then rang a bell (CS) before giving the meat powder. After some repetitions of this pairing of bell and meat the dog salivated to the bell alone, demonstrating what Pavlov called a conditional response, now commonly termed conditioned response or CR. Ivan Pavlov provided the most famous example of classical conditioning. During his research on the physiology of digestion in dogs, Pavlov developed a procedure that enabled him to study the digestive processes of animals over long periods of time. He redirected the animal's digestive fluids outside the body, where they could be measured. Pavlov noticed that the dogs in the experiment began to salivate in the presence of the technician who normally fed them, rather than simply salivating in the presence of food. Pavlov called the dogs' anticipated salivation, psychic secretion. From his observations he predicted that a stimulus could become associated with food and cause salivation on its own, if a particular stimulus in the dog's surroundings was present when the dog was given food. In his initial experiments, Pavlov rang a bell and then gave the dog food; after a few repetitions, the dogs started to salivate in response to the bell. Pavlov called the bell the conditioned (or conditional) stimulus (CS) because its effects depend on its association with food. He called the food the unconditioned stimulus (US) because

its effects did not depend on previous experience. Likewise, the response to the CS was the conditioned response (CR) and that to the US was the unconditioned response (UR). The timing between the presentation of the CS and US affects both the learning and the performance of the conditioned response. Pavlov found that the shorter the interval between the ringing of the bell and the appearance of the food, the stronger and quicker the dog learned the conditioned response.

### Example of Conditioned Stimulus (CS) and Unconditioned Stimulus (US)

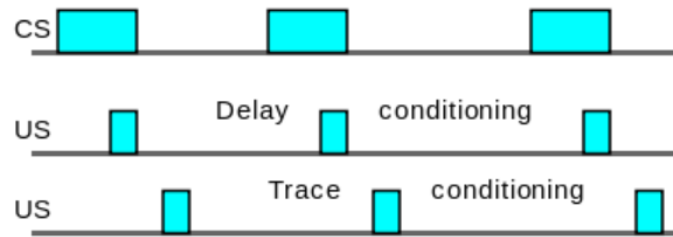

Learning is fastest in forward conditioning. During forward conditioning, the onset of the CS precedes the onset of the US in order to signal that the US will follow. Two common forms of forward conditioning are delay and trace conditioning.

- **Delay conditioning:** In delay conditioning the CS is presented and is overlapped by the presentation of the US.
- **Trace conditioning:** During trace conditioning the CS and US do not overlap. Instead, the CS begins and ends before the US is presented. The stimulus-free period is called the trace interval. It may also be called the conditioning interval.

### 2.3. Operant Conditioning

Operant conditioning (or instrumental conditioning) is a type of learning in which an individual's behavior is modified by its antecedents and consequences. Mechanisms of instrumental conditioning suggest that the behavior may change in form, frequency, or strength. The expressions operant behavior and respondent behavior were popularized by B. F. Skinner. The former refers to an item of behavior that is initially spontaneous, rather than a response to a prior stimulus, but whose consequences may reinforce or inhibit recurrence of that behavior. Operant conditioning is distinguished from classical conditioning (or respondent



conditioning) in that operant conditioning deals with the reinforcement and punishment to change behavior. Operant behavior operates on the environment and is maintained by conditioning of reflexive (reflex) behaviors which are also elicited by antecedent conditions, while classical conditioning is maintained by its antecedents and consequences. Behaviors conditioned through a classical conditioning procedure are not maintained by consequences. They both, however, form the core of behavior analysis and have grown into professional practices.

### Table of Operant Conditioning Process

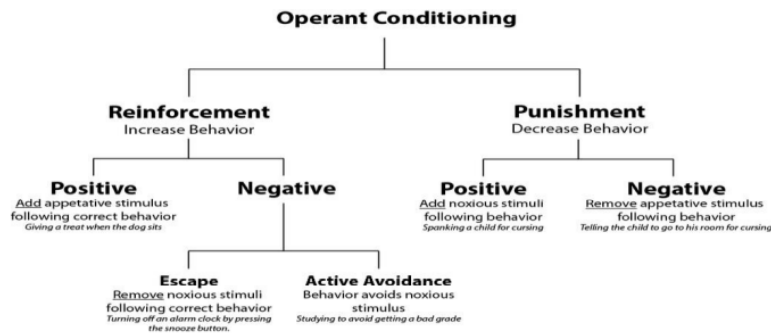

- Positive** presence of a stimulus
- Negative** absense of a stimulus
- Reinforcement** increases behavior
- Punishment** decreases behavior
- Escape** removes a stimulus
- Avoidance** prevents a stimulus

B.F. Skinner is the person whose work is most often cited in connection with operant conditioning. To implement his empirical approach, Skinner invented the operant conditioning chamber in which subjects such as pigeons and rats were isolated from extraneous stimuli and free to make one or two simple, repeatable responses. Another invention, the cumulative recorder, produced a graphical record of these responses from which response rates could be estimated. These records were the primary data that Skinner and his colleagues used to explore the effects on response rate of various reinforcement schedules. A reinforcement schedule may be defined as any procedure that delivers a reinforcer to an organism according to some well-defined rule. The effects of schedules became, in turn, the basic experimental data from which Skinner developed his account of operant

conditioning. He also drew on many less formal observations of human and animal behavior.

#### **2.4. Social Learning Theory**

Social learning theory states that learning is a cognitive process that takes place in a social context and can occur purely through observation or direct instruction, even in the absence of motor reproduction or direct reinforcement. In addition to the observation of behavior, learning also occurs through the observation of rewards and punishments, a process known as vicarious reinforcement. The theory expands on traditional behavioral theories, in which behavior is governed solely by reinforcements, by placing emphasis on the important roles of various internal processes in the learning individual. Within this context, Albert Bandura studied learning processes that occurred in interpersonal contexts and were not adequately explained by theories of operant conditioning or existing models of social learning, such as the work of Julian Rotter. Specifically, Bandura argued that the weaknesses of learning approaches that discount the influence of social variables are nowhere more clearly revealed than in their treatment of the acquisition of novel responses. Skinner's explanation of the acquisition of new responses relied on the process of successive approximation, which required multiple trials, reinforcement for components of behavior, and gradual change. Rotter's theory proposed that the likelihood of a behavior occurring was a function of the subjective expectancy and value of the reinforcement. This model assumed a hierarchy of existing responses and thus did not (according to Bandura) account for a response that had not yet been learned. Bandura began to conduct studies of the rapid acquisition of novel behaviors via social observation, the most famous of which were the Bobo doll experiments.

(observational learning or modeling). Thus, learning can occur without an observable change in behavior.

4. Reinforcement plays a role in learning but is not entirely responsible for learning.
5. The learner is not a passive recipient of information. Cognition, environment, and behavior all mutually influence each other (reciprocal determinism).

Social learning theory draws heavily on the concept of modeling, or learning by observing a behavior. Bandura outlined three types of modeling stimuli:

- **Live model** in which an actual person is demonstrating the desired behavior
- **Verbal instruction** in which an individual describes the desired behavior in detail and instructs the participant in how to engage in the behavior
- **Symbolic** in which modeling occurs by means of the media, including movies, television, Internet, literature, and radio. Stimuli can be either real or fictional characters.

Exactly what information is gleaned from observation is influenced by the type of model, as well as a series of cognitive and behavioral processes, including:

- **Attention** - In order to learn, observers must attend to the modeled behavior. Attention is impacted by characteristics of the observer (e.g., perceptual abilities, cognitive abilities, arousal, past performance) and characteristics of the behavior or event (e.g., relevance, novelty, affective valence, and functional value).
- **Retention** - In order to reproduce an observed behavior, observers must be able to remember features of the behavior. Again, this process is influenced by observer characteristics (cognitive capabilities, cognitive rehearsal) and event characteristics (complexity).
- **Reproduction** - To reproduce a behavior, the observer must organize responses in accordance with the model. Observer characteristics affecting reproduction include physical and cognitive capabilities and previous performance.
- **Motivation** - The decision to reproduce (or refrain from reproducing) an observed behavior is dependent on the motivations and expectations of the observer, including anticipated consequences and internal standards.

An important factor in social learning theory is the concept of reciprocal determinism. This notion states that just as an individual's behavior is influenced by the environment, the environment is also influenced by the individual's behavior. In other words, a person's behavior, environment, and personal qualities all reciprocally influence each other. For example, a child who plays violent video games will likely influence their peers to play as well, which then encourages the child to play more often. This could lead to the child becoming desensitized to violence, which in turn will likely affect the child's real life behaviors.

[Typ



[Type text]



## UNIT 3 - THEORIES OF LEARNING

### Structure

3.1 Introduction

3.2 Objectives

3.3 Behaviorist perspectives of Learning

3.4 Trial and Error - Thorndike

3.4.1 Experiment

3.4.2 Laws of Learning

3.4.3 Concepts and Principles

3.4.4 Classroom Implications

3.5 Classical Conditioning - Pavlov

3.5.1 Experiment

3.5.2 Concepts and Principles

3.5.3 Classroom Implications



What do we mean about classical conditioning?

## 3.6 Operant Conditioning - Skinner

### 3.6.1 Experiment

### 3.6.2 Concepts and Principles

### 3.6.3 Classroom Implications

## 3.7 Cognitive perspectives of Learning

## 3.8 Insight Learning - Kohler

### 3.8.1 Experiment

### 3.8.2 Educational Implications

## 3.9 Discovery Learning – Bruner

### 3.9.1 Theory

### 3.9.2 Classroom Implications

## 3.10 Developmental Theory of Learning – Piaget

### 3.10.1 Theory





[Typ



[Type text]



### 3.10.2 Classroom Implications

## 3.11 Social Learning – Bandura

### 3.11.1 Theory

### 3.11.2 Classroom Implications

## 3.12 Social Constructivism – Vygotsky

### 3.12.1 Theory

### 3.12.2 Classroom Implications

## 3.13 Humanist perspectives of Learning

### 3.13.1 Learner - Centered Approach

### 3.13.2 Classroom Implications

## 3.14 Let us Sum Up

## 3.15 Answers to ‘Check Your Progress’

## 3.16 Unit-end Activities

## 3.18 Suggested Readings

### 3.1 INTRODUCTION

The adaptability of man's adjustment to diverse environments and the impressive achievement in all the fields of life was accomplished by his learning capacity. Learning is said to occur whenever one adopts new behavior patterns or attitudes. The mechanism of behavior involved in the learning process is explained by Theories of Learning. Psychologists have formulated different theories of learning with the result that it is not possible to give a theory which satisfies learning needs of all the people.

Theory is defined as “a provisional explanatory proposition or a set of propositions, concerning some natural phenomena and consisting of symbolic representation of the observed relationships among the independent and dependent variables, the mechanisms or structures presumed to underlie such relationships or inferred relationships and underlying mechanisms intended to account for observed data in the absence of any direct empirical manifestations of the relationships” – Melvin H. Marx (1970) .

What happens in a learning process? How does an individual learn concepts, skills, habits, interests, attitudes and similar other changes in life? How learning in one area is transferred to other area? What are the ways of motivating pupils to learn? In this Unit, we are going to meet with these questions and find out answers which will be useful in knowing about the learning process.

### 3.2 OBJECTIVES

After learning this unit, you will be able to

- describe the theories of learning;
- elucidate the behaviorists, cognitive and humanist perspectives of learning;
- state the importance of learning theories ;
- list out the implications of learning theories in classroom;
- identify the need for reinforcement, rewards and punishments in the learning process.

### 3.3 BEHAVIORIST PERSPECTIVES OF LEARNING

Behaviorism was founded by John B. Watson in the early part of the 20th Century. This was the earliest formulation of a coherent theory of learning, at least in modern Western society. A variety of perspectives emerged over the next few decades including the work of Thorndike, Tolman, Guthrie, Hull, Skinner and others.

From the behaviorist perspective, three assumptions are held to be true. First, the focus was on observable behavior rather than on internal cognitive processes. If learning has occurred, then some sort of observable external behavior is apparent. Second, the environment is the modifier of learning and behavior, not individual characteristics. Third, principle of contiguity and reinforcement are central to explaining the learning process.

The behaviorist orientation is fundamental to much current educational practice, including adult education. Skinner believed the ultimate goal of education was to train individuals to behaviors which would ensure their personal survival, as well as the survival of cultures and the species. The teacher's role in this perspective is to provide an environment that elicits the desired behaviors and extinguishes the undesirable ones.

Educational practices which have these notions at their core include systematic design of instruction, behavioral and performance objectives, programmed instruction, competency-based instruction, and instructor accountability, training for skills and vocations are particularly heavily saturated with learning and being reinforced for "correct responses and behaviors".

### **3.4 TRIAL AND ERROR - THORNDIKE**

E. L. Thorndike (1874-1949) was the chief exponent of the theory of Connectionism or Trial and Error. The basis of learning accepted by Thorndike is an association between the sense, impressions and impulses to action. This association came to be known as a 'bond' or a 'connection'. Since it is these bonds or connections which become strengthened or weakened in the making and breaking of habits, Thorndike's system is some-times called a 'bond' psychology or simply 'connectionism'. As it believes in stimulus and response type of learning it is also called S. R. Psychology of learning. Thorndike called it learning by selecting and connecting. It is also known as Trial and Error theory as learning takes place through random repetitions.

### 3.4.1 Experiment

Once he locked a hungry cat in puzzle box and showed a meat outside. The ultimate aim of the hungry cat was to obtain the meat. The cat could come outside only when it opens the door by removing the latch, but it was unaware as to how to remove the latch. The cat did not know how to remove the latch at first but it involved in random activities like scratching the box, trying to bend the bars and stretching the feet outside. At last in its random activities it lifted up the latch and obtained the meat. He repeated the experiments and found out that the cat released the latch itself easily. The cat realized association between lifting of the latch and opening of the door. The random activities are called errors. Finally he concludes that the numbers of trails will reduce the wrong responses and finally correct response is found. Hence, a

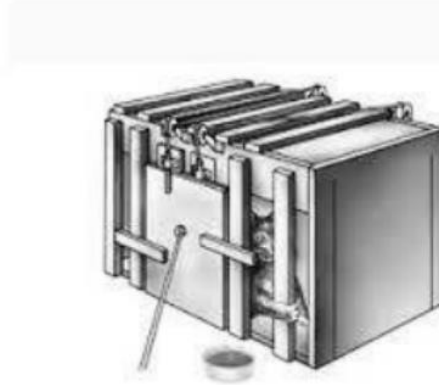

bond is established between stimulus and correct response through elimination of wrong responses.

### 3.4.2 Laws of Learning

Thorndike draws three laws of learning:

#### *Law of Readiness:*

If a bond is ready for its establishment, it has to give satisfaction but not annoyance. If a learner has to learn an action or activity he should be mentally and physically fit for the action he desired. His mental set should have the capacity to do the work. A two year boy cannot be admitted in the school since he is not matured enough. A child of one year cannot speak since his vocal cards, larynx are not grown enough. Hence, maturity is essential.

### ***Law of Effect:***

If the result of the bond created between stimulus and a response leads to happiness it will strengthen the bond and if the result is contrary the bond will be weakened. A child will be in a happy mood if he finds out correct answers from his mathematical exercises but will be unhappy if the answers are wrong. If a student passes his examination he will feel happy and he will be unhappy if he fails. “Nothing succeeds like success”. This proverb is applicable to this law. This law is also called “**law of stratification and annoyance or reward and punishment**”.

### ***Law of Exercise:***

The bond of stimulus and a response will get strengthened if it is repeated. It will lose its strength if the bond is not repeated. The law of exercise emphasizes that “Practice make a man perfect”. This law of exercise is also known as “Law of use and disuse”.

### **3.4.3 Concepts and Principles**

1. *Learning involves trial and error or selection & connection:* In the experiment, the cat tried for correct response by stamping in and out, attempted to reach the meat. Selection and connection of proper responses to connect or associate them with adequate stimuli, Example:



Subsequent trials, cat tried to avoid the erroneous moves and to repeat the correct manner manipulating the latch.

2. *Learning is the result of formation of connections:* Mind is associated with the connection in the nervous system between stimuli and response. Mind is man's connection system where there is association between senses, impressions, impulses and actions. This association may be strengthen or weaken resulting in making or breaking habits. This type of association is known as connectionism or bond psychology.

3. *Learning is incremental, not insightful:* Learning performance depends on number of trial or opportunities. Increase in number of trial or practice performance gradually improves known as incremental performance. Such type of learning is called incremental learning. Example: Solution of a problem does not strike the mind of the animal at one & the time an animal needs to find a solution to a problem depends on the number of trials it get to solve it.

4. *Learning is direct not by ideas:* Learning is direct not mediated ideas reasoning or thinking. Learning is simple mechanical phenomenon a process of establishing a simple a connection between sensory stimuli and appropriate responses. Example: That cat does not look over the situation, much less think it over, and then decide what do it. It burst out once into the activities helped by instincts & experiences.

#### 3.4.4 Classroom Implications

Thorndike's Theory of trial and error and laws of learning have great educational significance. Thorndike's findings have made the learning purposeful and goal directed. Trial and error, coupled with insight will make the process of learning more effective, important educational implications are:

- i. This theory substantiated that readiness is preparation for action which is very essential for learning. If the child is ready to learn, he learns more quickly, effectively and with greater stratification than if he is not ready to learn. He warns us not to make the child learn till he is ready to learn and also not to miss any opportunity of providing learning experiences if he child is, already prepare to learn. The right movements concerning the learning situation and the learner's state of mind should be very well recognized and

maximum use of this knowledge should be made by the teacher. He should also make an attempt to motivate the students by arousing their attention, interest and curiosity.

- ii. The law of effect emphasizes the role of rewards and punishment in the process of learning. Getting reward as a result of some learning motivates and encourages the child to proceed on the same path with more intensity and enthusiasm while the punishment of any sort discourages him and creates distaste and distraction towards that learning.
- iii. In the teaching – learning process, the teacher try to strengthen the bonds and connections between the stimuli and the responses those things which are to be remembered by the learners. This could be done through drill, repetition and reward. For forgetting he should make attempts to weaken the connections through disuse and annoying elements. \
- iv. Repetitions in learning strengthen the connections in achieving the goal which could be achieved by rewarding the correct responses.
- v. The child should be encouraged to do his work independently by the strengthening effect of rewards rather than weakening effect of punishment.

### 3.5 CLASSICAL CONDITIONING – PAVLOV

In 1904, Russian psychologist Ivan Pavlov, during his experimental work on dog's digestive process, accidentally noticed the secretion of saliva in the dog on the sight of food or hearing the footsteps of the caretaker. Conditioning can be defined as "a process in which a neutral stimulus which is not associated with any specific natural response, on pairing with a natural stimulus acquires all the characteristics of natural stimulus." for example, if food is presented, saliva flows. Food is the 'natural stimulus' (or unconditioned stimulus-U.C.S.) that can elicit the 'natural response' (or unconditioned response-U.C.R) salivating'. The sound of a bell which is a neutral stimulus, not associated with any specific response originally, when paired with food a number of times, acquires the characteristics of food and starts eliciting the response of salivation, even when presented alone. Now we say the dog has been conditioned to the sound of bell and we refer the bell sound as 'conditioned stimulus' (C.S.) and salivation as 'conditioned response' (C.R.). Classical conditioning of Pavlov is also called 'stimulus substitution' because

we substitute a neutral stimulus, through the process of 'contiguity' (occurrence of two events in quick succession).

#### 3.5.1 Experiment

A hungry dog was brought into a laboratory and food was shown. The sight of food is smell of the food made the dog salivate. The amount of saliva secreted was measured. The real experiment started. At one stage before offering the food, the small sound of bell was given to the dog. When a number of trials continued like this, the dog salivated even without seeing the food but by just hearing the bell. This is because the dog made an association or connection between the sound of the bell and the arrival of food. The sequence is as follows:

Food (US)	Salivation (UR)
Bell (CS)	Listening
Bell (S1) (CS) + Food (S2) (US)	Salivation (UR)
Bell (CS)	Salivation (CR)

Where,

US means Unconditioned Stimulus i.e. natural

CS means Conditioned Stimulus i. e. artificial

UR means Unconditioned Response

CR means Conditioned Response

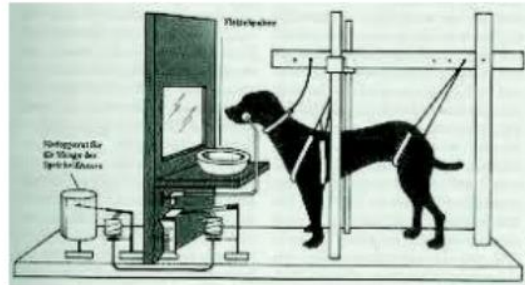

Experiment for Pavlov's Classical conditioning

Conditioning means making a connection between an artificial stimulus and natural response. This becomes possible because a connection is made between an artificial stimulus and a natural stimulus.



<https://www.youtube.com/watch?v=qSgWiTG-o2Y>

To understand Pavlov's Theory you need to know:

- 1) The Unconditioned Stimulus (US)
- 2) The Unconditioned Response (UR)
- 3) The Neutral Stimulus (NS)
- 4) The



Pavlov's Theory of Classical Conditioning Explained!

### 3.5.2 Concept and Principles

#### i) Principle of Acquisition:

Acquisition is the initial stage of learning when a response is first established and gradually strengthened. For example, imagine that you are conditioning a dog salivate in response to the sound of a bell. You repeatedly pair the presentation of food with the sound of the bell. You can say the response has been acquired as soon as, you can gradually reinforce the salivation response to make sure the behavior is well earned.

#### ii) Principle of Extinction:

Extinction is when the occurrences of conditioned response decrease or disappear. In classical conditioning, this happens when a conditioned stimulus is no longer paired with an unconditioned stimulus. For example, if the smell of food (unconditioned stimulus) had been paired with the sound of a whistle (conditioned stimulus), it would eventually come to evoke the conditioned response of hunger. However, if the unconditioned stimulus (the smell of food), were no longer paired with the conditioned stimulus (the whistle), eventually the conditioned response (hunger) would disappear.

**iii) Principle of spontaneous recovery:**

Spontaneous recovery is the reappearance of the conditioned response after a rest period or period of lessened response. If the conditioned stimulus and unconditioned stimulus are no longer associated, Extinction will occur very rapidly after a spontaneous recovery.

**iv) Principle of Stimulus Generalization:**

Stimulus generalization is the tendency for the conditioned stimulus to evoke similar response after the response has been conditioned. For example, if a child has been conditioned to fear a suffered white rabbit, the child will exhibit fear of objects similar to conditioned stimulus.

**v) Principle of Discrimination:**

Discrimination is the ability of differentiate between a conditioned stimulus and other stimuli that have not been paired with an unconditioned stimulus. For example, if the bell tone were the



How do we apply the Pavlov principles in education ?



conditioned stimulus, discrimination would involve being able to tell the difference between the bell tone and other similar sounds.

### 3.5.3 Classroom Implications

- 1) Classical conditioning is used in language learning by associating words with picture or meanings.
- 2) It can be used to develop favorable attitude towards learning, teacher's subjects and the school.
- 3) Developing good habits in children such as cleanliness, respect for elders, punctually, etc. through the use of conditioning.
- 4) Breaking of bad habits and elimination of conditioned fear, through the use of reconditioning process.

### 3.6 OPERANT CONDITIONING - B. F. SKINNER

Prof. Skinner started his research work on behavior while he was a graduate in the department of psychology of the Harvard University. In 1931, he wrote his thesis entitled, *The Concept of the Reflex in Description of the Behavior*. Skinner was a practical psychologist who conducted several experiments on rats on pigeons. He popularized 'teaching machines' in learning in 1954.



Give an example of how to apply operant conditioning in class?

### 3.6.1 Experiment

Skinner at first tested this theory with rats. Later, he experimented the test with pigeons. With bar and a food tray he constructed a puzzle box and drove a hungry rat into the puzzle box.

The hungry rat wandered here and there and pushed the bar. The bar and the food tray had its connections. When the rat pushed the bar down a food pellet fell into the tray and it ate the food. The rat learned the task of pressing to get food on needs from which we can understand that reinforcement is needed to achieve a task.

In experiments on pigeons a pigeon was rewarded with a food pellet when it approached a disc and pecked it. Skinner was able to shape even the behavior of birds.

In the theory of skinner's operant conditioning, giving correct response is more important. This type of conditioning is called instrumental conditioning since the response is



<https://www.simplypsychology.org/operant-conditioning.html>

instrumental in drawing unconditioned stimulus. Here stimulus's is only one. In Pavlov's classical conditioning theory, we have two conditioned stimuli which precede the response whereas in Skinner's operant conditioning theory. It is one unconditioned stimulus which come later, desired response is reinforced by unconditioned stimulus.

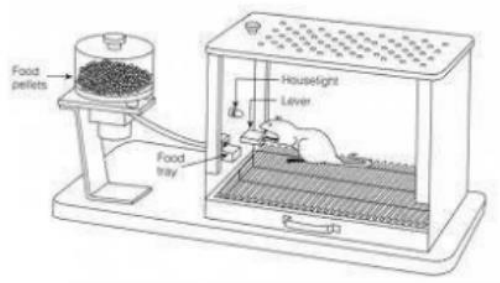

An illustration showing Skinner's Classical conditioning theory

### 3.6.2 Concepts and Principles

#### i) Positive reinforcement

Skinner showed how positive reinforcement worked by placing a hungry rat in his skinner box. The box contained a lever on the side and as the rat moved about the box it would accidentally knock the lever. Immediately it did so a food pellet would drop in to a container next to the lever. The rat quickly learned to go straight to the lever after a few times of being put in the box. The consequence of receiving food if they pressed the lever ensured that they would repeat the action again. Positive reinforcement strengthens a behavior by providing a consequence an individual finds rewarding.

#### ii) Negative reinforcement:

The removal of an unpleasant reinforce can also strengthen behavior. This is known as Negative reinforcement because it is the removal of an adverse stimulus which is “rewarding” to the animal or person. Negative reinforcement strengthens behavior because it stops or removes an unpleasant experience.

### iii) Punishment (weakens behavior)

Punishment is defined as the opposite of reinforcement since it is designed to weaken or eliminate a response rather than increase it .it is an adverse event that decreases the behavior that it follows.

#### 3.6.3 EDUCATIONAL IMPLICATIONS

- i. For developing the motivation in the students for classroom work by reinforcement like praise, blames, grades etc., should be used.
- ii. Skinner's principles of learning focus attention on the individual's pace of learning. Teaching machines and the programmed learning system have been devised on the basis of the theory of learning founded by skinner.
- iii. In the classroom, the principle of immediacy of reinforcement is very important. Praise for a job done well given immediately can be a stronger reinforce or motivator than a grade given much latter.
- iv. The schools should practice the principle of operant conditioning namely to destroy the elements of fear from school atmosphere by using positive reinforcement.
- v. Desired behaviors of students should be reinforced at once to increase the likelihood or reoccurrence of the behavior in future. Each step of the behavior is to be reinforced.



**Check Your Progress – 1**

1. State the laws of learning.

.....  
.....  
.....  
.....

2. Mention the principles of Pavlov’s classical conditioning theory.

.....  
.....  
.....  
.....

[Typ



[Type text]



## 4- Write Learning theories



Gestalt School on Learning

Chapter 10

1

---

---

---

---

---

---

---

[Typ



[Type text]



### History of Gestalt Psychology

1. Max Wertheimer, along with Kurt Koffka and Wolfgang Köhler founded the Gestalt School of Psychology and studied perceptual and other phenomena based on Kantian and other German philosophies. Their ideas started appearing in 1912.
2. Separated by WWI, three individuals united again to form the [Gestalt of the Berlin School](#), and stayed in Germany till the 1930s and then migrated to the US.

2

---

---

---

---

---

---

---

---





### History of Gestalt Psychology

3. In the US, Wertheimer at New School for Social Research, Koffka at Smith College, Kohler at Swarthmore College, and Lewin at Cornell and the University of Iowa continued to work on expanding gestalt ideas.
4. Gestalt school made enormous contributions to psychology. Their motto, "the whole is different from the sum of its parts", gained household popularity. Although they confronted opposition from behaviorism, their ideas inseminated current cognitive psychology.

2

---

---

---

---

---

---

---

[Typ



[Type text]



### Max Wertheimer

1. Born Apr. 15, 1880 in Prague, Czechoslovakia.
2. Worked with Koffka and Kohler on Gestalt psychology. Their work was interrupted by WWI.
3. After war he joined Psychological Institute at the University of Berlin.



(1880-1943)

4

---

---

---

---

---

---

---

[Typ



[Type text]



### Max Wertheimer

4. From 1929 to 1933, Wertheimer was a professor at the University of Frankfurt.
5. When Hitler became the third Reich, Wertheimer left Germany and came to the US on Sep. 13, 1933.



(1880-1943)

5

---

---

---

---

---

---

---

### Max Wertheimer

- 6. Joined New School for Social Research, New York.
- 7. With ill health, continued to work on problem-solving, and wrote *Productive Thinking* (1945) published two years after his death.
- 8. Died Oct. 12, 1943.



(1880-1943)

6

---



---



---



---



---



---



---



### Comparison of Schools

Structuralism	Behaviorism
Mind (Wundt)	Behavior (Watson)
Structuralists concentrated on the <b>elements of mind</b> (mind = sensations, feelings, and images).	Behaviorists believed in <b>elements of behavior</b> (behavior = S-R associations).
Believed that complex mental ideas were made up of simple ideas (see J. S. Mill).	Complex behaviors are made up of simple behaviors (reflexes).

---



---



---



---



---



---



---

[Typ



[Type text]



### Comparison of Schools

Structuralism	Behaviorism
Introspection Observation and Experimentation	Observation and Experimentation

Whatever the phenomena of their study (mind or behavior), both schools of thought were similarly driven by a reductionist approach to break down mind or behavior into elements.

---

---

---

---

---

---

---

---

[Typ



[Type text]





[Typ



[Type text]



### Gestalt Psychology

Structuralism	Behaviorism	Gestalt
Elements of mind	Elements of behavior	Mind or behavior must be studied in "wholes", not as elements or parts.
Molecules of mind	Molecular behavior	Molar behavior or mind
Introspection Observation and Experimentation	Observation and Experimentation	Introspection Observation and Experimentation
Approach: Mental	Approach: Behavioral	Approach: Cognitive

---

---

---

---

---

---

---

---

[Typ



[Type text]



### The word *Gestalt*

The German word *gestalt* can be translated to means form, pattern, configuration. This configuration or pattern offers an "organization" to perception which the individual experiences.

10

---

---

---

---

---

---

---



### Phi Phenomenon

On a train ride, Wertheimer was stuck by a curious phenomena of jumping lights from one pole to another. He quickly conducted experiments, and discovered **phi phenomenon**.



Phi phenomena: when two lights flash at a certain speed, we perceive a singular light oscillating back and forth.

11

---

---

---

---

---

---

---

---

[Typ



[Type text]



Phi Phenomenon: Rotating Hoop

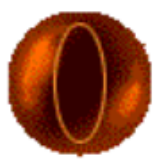

Phi phenomena: The hoop above gives the impression that it is rotating on its axis.

12

---

---

---

---

---

---

---

---

[Typ



[Type text]



### Phi Phenomenon: Movies

We experience phi phenomena when we watch movies. The movie projector presents a series of still picture in quick succession, giving us the illusion of motion.



er1.LaurelBul.jpg 48

12

---

---

---

---

---

---

---

---

[Typ





[Type text]



**Phi Phenomenon: Reality**

Phi phenomena is a perceptual experience that is different from the sum of sensory elements.

Two Lights 

Shrinking-expanding hoop 

Series of still pictures 

©1.ankholzinger 14

---

---

---

---

---

---

---

---



### Phenomenological Experiences

This lead gestalt psychologists to question the reality of sensory and subsequent phenomenological (perceptual) experience. They proposed that perceptual experiences were not the sum of sensory elements.

Sensory Experience	Phenomenological Experience
--------------------	-----------------------------

Flashing lights, shrinking-expanding hoop, and still pictures	Apparent motion
---	-----------------

15

---



---



---



---



---



---



---



[Typ



[Type text]



### Perceptual Organization

The question then was how was our phenomenological or perceptual experiences organized? What were the principles or laws that underlay our perception? Gestalt psychologists developed a number (over hundred) of laws that organized perception.

16

---

---

---

---

---

---

---

**Law of Similarity & Proximity**

Similarity

Proximity

**Similarity** Pieces that are similar are grouped together. Most see vertical columns of circles and squares.

**Proximity** Near objects are grouped together. We perceive one group of circles going vertical the other horizontal.

17

---



---



---



---



---



---



---

### Pointillism



Yellow inset blown for details.

Painters like George Seurat have used laws like similarity and proximity to paint his pictures. *Sunday afternoon at the Grand Jatte.*

18

---



---



---



---



---



---



---

**Law of Continuity & Closure**

Continuity

Closure

**Continuity** Pieces in smooth continuation are grouped together. Most people view the lower line next to the red arrow as continuous.

**Closure** Missing elements are supplied to complete a familiar figure. We perceive an illusory triangle and a pyramid in kanizsa triangles.

---



---



---



---



---



---



---

[Typ



[Type text]



**Law of Simplicity**



Rings?



Pentagon, rectangle  
and a triangle?

**Simplicity** Pieces are organized in simplest possible ways.  
Most people view five rings (left) and a triangle, pentagon and a rectangle (right).

20

---

---

---

---

---

---

---

---

### Law of Figure & Ground



Vase or Faces?

**Figure and Ground** When viewed as figure, faces or vase stands out in front of the background. This perception is not stable and oscillates back and forth between faces and vase.

21

---

---

---

---

---

---

---

---



### Law of Prägnanz

1. Law of Prägnanz (Prägnanz mean "essence") is an overriding principle that envelops all perceptual laws.
2. The law is defined as a tendency that makes every psychological event simple, concise, symmetrical, harmonious and complete.
3. Not only was this law used as a guiding principle for studying perception, but also memory, learning, personality and psychotherapy.

22

---

---

---

---

---

---

---



[Typ



[Type text]



### Law of Prägnanz

4. Thus, law of prägnanz makes our physical environment meaningful, and in many ways also our behavioral and social environments. Bringing meaning and completeness to our beliefs, values, needs, and attitudes.
5. The tendency (essence) that makes psychological, behavioral, or social events meaningful is based on field forces our brain generates.

23

---

---

---

---

---

---

---

---

[Typ



[Type text]



### Kurt Zadek Lewin

1. Born 9 Sep. 1890 in Mogilno, Poland.
2. Did his PhD from University of Berlin under Carl Stumpf.
3. Migrated to the US in 1933.
4. Worked at Cornell, and for the Child Welfare Research Station at the University of Iowa.



(1890-1947)

24

---

---

---

---

---

---

---

---

[Typ



[Type text]



[Typ



[Type text]



### Kurt Zadek Lewin

5. Later became the director of the Center for Group Dynamics at MIT.
6. Worked with Connecticut State Inter Racial Commission to combat religious and racial prejudices. Developed **sensitivity training**.



(1890-1947)

25

---

---

---

---

---

---

---

[Typ



[Type text]



### Kurt Zadek Lewin

7. Recognized as the "founder of social psychology".
8. Formed a theory of human motivation around field theory.
9. Died in Newtonville, Massachusetts in 1947.



(1890-1947)

26

---

---

---

---

---

---

---

---

### Field Theory

1. Gestalt psychology borrowed the concept of field theory from physics. In its simple form one can think of a magnet that generates a magnetic field.
2. A **field** can be defined as a dynamic, interrelated system, where one part influences other parts in the system.

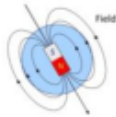

27

---

---

---

---

---

---

---

---

[Typ



[Type text]



[Typ



[Type text]



### Field Theory

3. So field theory in gestalt psychology assumes that behavior and cognitive processes are part of a field that affect each other. These processes can be memories, beliefs, perceptions, physiology, etc.
4. Any change in one process changes the whole pattern. World looks different on an upset stomach or a sad memory.
5. A field can exist at many levels. Perceived environment can be a field. All people in the environment can be another field, etc.

28

---

---

---

---

---

---

---





### Motivation: Field Theory

1. Kurt Lewin formed a theory of human motivation which was built around field theory.
2. Human behavior, he suggested, at any given time is determined by total number of **psychological facts** (field).
3. A psychological fact is anything a person is conscious of including being hungry, being in a physical location, or having money, or being conscious of some memory.

29

---

---

---

---

---

---

---

### Motivation: Field Theory

4. All conscious psychological facts makes our **life space** which continuously change. Some facts exert positive influence on us, while others have a negative affect. Interaction of these facts determines behavior.

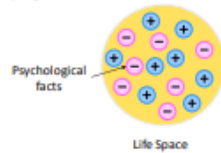

---

---

---

---

---

---

---

---

**Brain**

1. Brain is a physical system that acts (as if generating a magnetic field) on incoming sensory information (iron particles) to make it more meaningful and organized.
2. Brain's ability to do so is neither learned nor inherited. This ability is inherent to any physical system, brain is one of them.

⇒

Incoming sensory  
information organized  
by brain's field

21

---

---

---

---

---

---

---

---

[Typ



[Type text]



### Brain

Gestaltists	Behaviorists
Brain plays an active role.	Passive receiver of sensations.
Makes sensory information more meaningful.	Switchboard. Storehouse of sensory information.
Making information more meaningful affects the behavior of the individual.	Brain does not affect behavior. Whistle does no control the speed of the locomotive.

32

---

---

---

---

---

---

---

---

[Typ



[Type text]



### Brain-Mind Problem

Different schools of thought have addressed the issue of brain (body) and mind relation, and have come up with different answers.

1. Behaviorists did not believe in mind or consciousness, therefore ignored it.
2. To voluntarists, mind alters sensory information to initiate behavior.
3. Structuralists believed, passive sensation made mind with no association with behavior (epiphenomenalism).

23

---

---

---

---

---

---

---

---

[Typ



[Type text]





### Brain-Mind Problem

- 4. For gestaltists, sensations were altered by mind (law of prägnanz). Active processing in the brain generated the mind, or physiological processes in the brain were mirror image of mental events and vice versa (*isomorphism*).

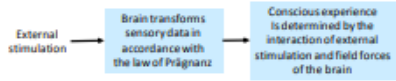

34

---



---



---



---



---



---



---

### Blind Spot and Closure

Since our brain (mind) can alter sensory information. Neuroscientists have demonstrated that omission in sensory information when lands on our blind spot or scotomas can be filled in (law of closure) to construct mental images.

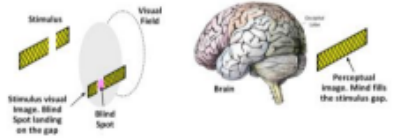

25

---



---



---



---



---



---



---



[Typ



[Type text]



## Reality and Environment

1. Because mind or consciousness transforms sensory information, **objective reality** is never experienced directly. What we gather then is our **subjective reality** and our behavior is dependent on it.
2. Thus we live in two kinds of environments, **geographical environments** which we physically share with others, and **behavioral environment** which consists of our perceptions, attitudes, beliefs, and values etc., which is not shared with others.

26

---

---

---

---

---

---

---

---

[Typ



[Type text]



## Gestalt Principles of Learning

17

---

---

---

---

---

---

---

### Wolfgang Köhler

1. Born Jan. 21, 1887 in Tallinn, Estonia.
2. Studied at the University of Tübingen (1905-06), University of Bonn (1906-07) and the University of Berlin (1907-09).
3. From 1910-13, worked as an assistant at the Psychological Institute in Frankfurt.



(1887-1967)

28

---

---

---

---

---

---

---

---

### Wolfgang Köhler

4. Köhler became the director of the Prussian Academy of Sciences anthropoid research station (Tenerife, 1913), where he studied learning in apes.



(1887-1967)



29

---

---

---

---

---

---

---

---

[Typ



[Type text]



[Typ



[Type text]



## Wolfgang Köhler

5. Köhler wrote *The Mentality of Apes (1917/1925)* and *Simple structural functions in the chimpanzee and in the chicken (1917/1938)*.
6. Became the director of the Psychological Institute at the University of Berlin (1920-1935).



(1887-1967)

40

---

---

---

---

---

---

---

---

[Typ



[Type text]



### Wolfgang Köhler

- 7. Moved to US (1935) as a professor at Swarthmore College.
- 8. Became the president of American Psychological Association (1959).
- 9. Died on Jun. 11, 1967 in Hanover, New Hampshire.



(1887-1967)

41

---

---

---

---

---

---

---

---

### Detour Problems

To study insightful learning, Köhler tested apes and chickens with detour problems. He found animals learn with insight, however, there were species differences in the ability to solve them, apes did better than chickens.

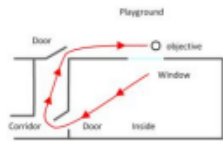

42

---



---



---



---



---



---



---



**Reaching Problems**

Chica using pole to obtain food    Grande using boxes to obtain food    Grande using boxes to obtain food (Stage 1)    Stage 2

**Köhler tested apes with reaching problems (vertical) in open field. Animals vicariously and behaviorally tested their solutions for presented problems.** 43

---



---



---



---



---



---



---

[Typ



[Type text]



[Typ



[Type text]



### Reaching Problems



In other kinds of reaching problems a horizontal orientation was utilized. Sultan, Köhler's smartest ape is seen getting food by assembling sticks. <sup>44</sup>

---

---

---

---

---

---

---

---

[Typ



[Type text]



### Perception and Learning

1. For gestalt psychologists learning was a special problem of perception. Problem (to learn), caused perceptual disequilibrium, which motivated the organism to solve it. Problem solution restored perceptual equilibrium and brought motivational relief (**Zeigarnik Effect**).
2. While solving insightful problems, Köhler observed, animals would take long period of contemplation in which they would run **vicarious trial-and-error** sessions. When correct solution was discovered, insight occurred.

45

---

---

---

---

---

---

---

---

### Perception and Learning

3. What brings the solution to the problem, is law of prägnanz. Prägnanz, simplifies perception (perceptual equilibrium), and brings solution to the problem, with a satisfying “aha” experience.
4. So law of closure, brings comprehension to meaningless arcs and blotches and makes the figures meaningful.



---



---



---



---



---



---



---

[Typ



[Type text]



### Insightful Learning: Characteristics

1. Transition from presolution to solution is sudden and complete.
2. When solution to the problem dawns, performance is smooth and without errors.
3. Insightful learning leads to longer retention.
4. The principle gained by insight is easily applied to other problems (transfer of training).

67

---

---

---

---

---

---

---

### Insightful Learning

Thorndike	Köhler
Thorndike did not find any insightful learning in animals.	Köhler clearly showed insightful learning in animals.
	If essential portions of the apparatus could be seen by the animals, they would have tackled the situation with insight.

48

---



---



---



---



---



---

[Typ



[Type text]



### Insightful Learning

Thorndike	Köhler
Thorndike did not think that animals or humans could learn principles (see belongingness and principle of polarity).	Köhler suggested animals learn principles (gestalts) with insightful learning.

49

---

---

---

---

---

---

---



[Typ



[Type text]



### Relational Principle: Transposition

Köhler argued that animals learn principles once insightful learning was achieved. For example chickens (and apes) learnt a relational principle (transposition) when they correctly discriminated between a darker and a lighter colored square.



Phase 1: Training



Phase 2: Testing

50

---

---

---

---

---

---

---

---

### Behaviorist's Rebuttal

Kenneth Spence (1942) rebutted and experimentally showed that discrimination in animals (chimps) was based on behavioral factors like habit strength, inhibition, and stimulus generalization, and not a relational principle.

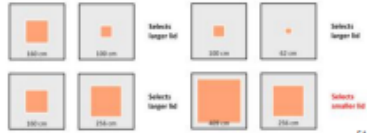

---



---



---



---



---



---



---



### Behaviorist's Rebuttal

Differences between stimulus generalization distributions for larger and smaller lids lead to selection of the larger lid up to a point, after which the smaller lid was selected (Spence, 1942).

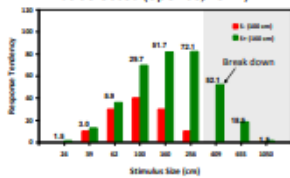

52

---



---



---



---



---



---



---

### Kurt Koffka

1. Born Mar. 18, 1886 in Berlin, Germany.
2. Earned his PhD under Carl Stumpf 1909.
3. Koffka worked with Wertheimer and Kohler at University of Frankfurt till 1912, but then moved on to University of Giessen (1912-1924).



(1886-1941)

53

---

---

---

---

---

---

---

---



### Kurt Koffka

- 4. When migrated to US he remained at Cornell (1924-25), University of Wisconsin-Madison (1925-27), and eventually to Smith College (1927-41) till his death.
- 5. Died Nov. 22, 1941, Northampton, Massachusetts.



(1886-1941)

64

---



---



---



---



---



---



---

[Typ



[Type text]



[Typ



[Type text]



### Memory Trace

1. Since brain modifies all incoming sensory information, many think that this arrangement may have little room for making memories.
2. Koffka (1935), attempted to clarify that with a concept of **memory trace**. When an experience terminates its effect remains as a **trace** in the brain and affects future experiences.

56

---

---

---

---

---

---

---

---



### Memory Trace

3. A process (trace) caused by an experience in "pure" form happens only once. Thereafter it each new experience (trace) interacts with an old trace forming a **trace system**.



56

---

---

---

---

---

---

---



### Education & Productive Thinking

1. Wertheimer in *Productive Thinking (1945)* used gestalt principles towards education. He contrasted productive thinking from rote learning, for latter was without understanding, rigid, easily forgotten, and could be applied in a limited fashion to other situations.
2. When learner uses problem solving he learns with understanding using gestalt principles. Learning is flexible, remembered for a long time, and can be applied to various other situations (transfer of training).

57

---

---

---

---

---

---

---

[Typ



[Type text]



[Typ



[Type text]



### Education & Productive Thinking

3. To generate productive thinking, students should arrange and rearrange the problem in many ways until the solution emerges based on understanding.
4. Wertheimer added that learning with logic or S-R associations would lead to limited learning. He came up with a number of examples to show that.

58

---

---

---

---

---

---

---

### Finding Areas

Students can be taught to find areas of rectangles by using algebraic formulas like length X height (L X H). However, when students are given nonstandardized figures, such formulas lead to erroneous answers.



Formula works for parallelogram



Formula does not Works for nonstandard figures

---



---



---



---



---



---



---

### Ready !

The correct way to learn to finding areas is to understand the concept of unit area or a grid. Unit area can then be applied to any standard or nonstandard figure, to calculate its area.

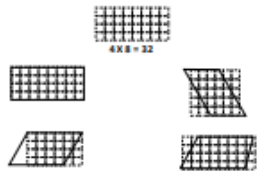

60

---



---



---



---



---



---



---

[Typ



[Type text]



Ready !

Rote Learning

1 4 9 1 6 2 5 3 6 4 9 6 4 8 1

Write the number

Rule Learning

<u>1</u>	<u>2</u>	<u>3</u>	<u>4</u>	<u>5</u>	<u>6</u>	<u>7</u>	<u>8</u>	<u>9</u>
1	4	9	16	25	36	49	64	81

64

---

---

---

---

---

---

---

[Typ



[Type text]





[Typ



[Type text]



## Evaluation

Contributions	Criticisms
Criticism of molecular approach of S-R behaviorism.	Explaining learning in terms of <b>meaning and organization</b> were meaningless in the behavioral context.
Brain as a system used to organize sensory experience.	Gestalt psychology never attained mainstream status as a learning theory.
Organizational processes in Gestalt psychology had impact on perception, learning, and psychotherapy.	

62

---

---

---

---

---

---

---

---

[Typ



[Type text]



### Questions

26. Explain transposition both from the point of view of Gestalt psychologists and behaviorists. Which seems more correct to you?
27. What is law of Prägnanz? What is meant by it being the overriding principle in Gestalt theory?

63

---

---

---

---

---

---

---

[Typ



[Type text]

