

Notes
of
practical physiology
for
B.SC students

contents

No	name	page
1	Electrical circuits and nerve-muscle preparation	1
2	Simple muscle curve	7
3	Effect of two successive stimuli on nerve muscle preparation	12
4	Effect of several stimuli on nerve muscle preparation	16
5	Phenomenon of fatigue	19
6	Effect of temperature on	23

	nerve muscle preparation	
7	Structure of frog's heart	27
8	Rhythmicity and conductivity of frog's heart	29
9	Introduction of heart experiments	31
10	Experiment to study properties of heart muscle	36
11	Effect of Temperature and drugs on the heart muscle	42
12	Effect of Temperature and pace-maker	47

13	Excitability and contractility	49
14	The perfusion of the frog's heart	52

Electrical Circuits and Nerve Muscle Preparation

Sources of Current

The 'main supply' current has a voltage of AC 220 volts. (50 Hz). A central low voltage unit consisting of a transformer with rectifier unit helps to produce a direct current of 2-15 volts. This is then fed to the primary coils of the Induction Coil to get induced current which is used in the experimental work in the laboratory.

Circuit A

Drum in primary circuit for single make and break shocks.

It consists of the Primary Circuit with the drum, Primary Key, Primary Coils of the Induction Coil and the low DC voltage source, for e.g. 6 DC (Source of Current).

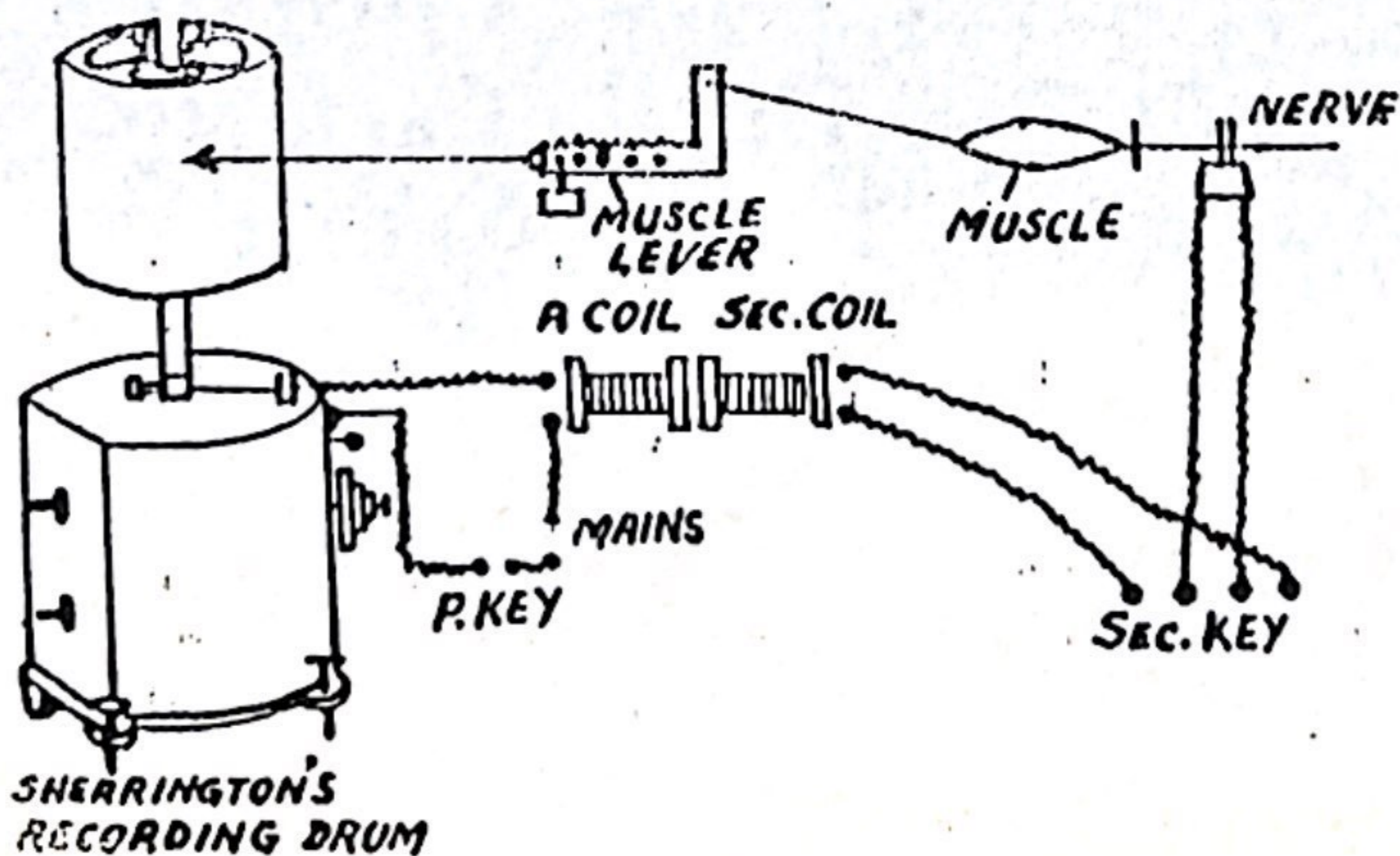

P. Key is Primary Key
P. Coil is Primary Coil

Sec. Key is Secondary Key
Sec. Coil is Secondary Coil

Fig. 17. Circuit A.

Electrical Circuits

The secondary circuit consists of secondary coils of induction coil, short circuiting key, electrodes, nerve muscle preparation, muscle lever and the smoked drum. The exact placement is shown in the diagram (Fig. 17).

The circuit can be used to obtain a single make or break shock by the help of primary key or short circuiting key.

Circuit B

Drum excluded from primary circuit for multiple make and break shocks.

Drum is excluded from the primary circuit and NEEF's hammer is included. Multiple 'Make' and 'Break' shocks can be obtained by the Neef's hammer.

The rest of the circuit is similar as in A.

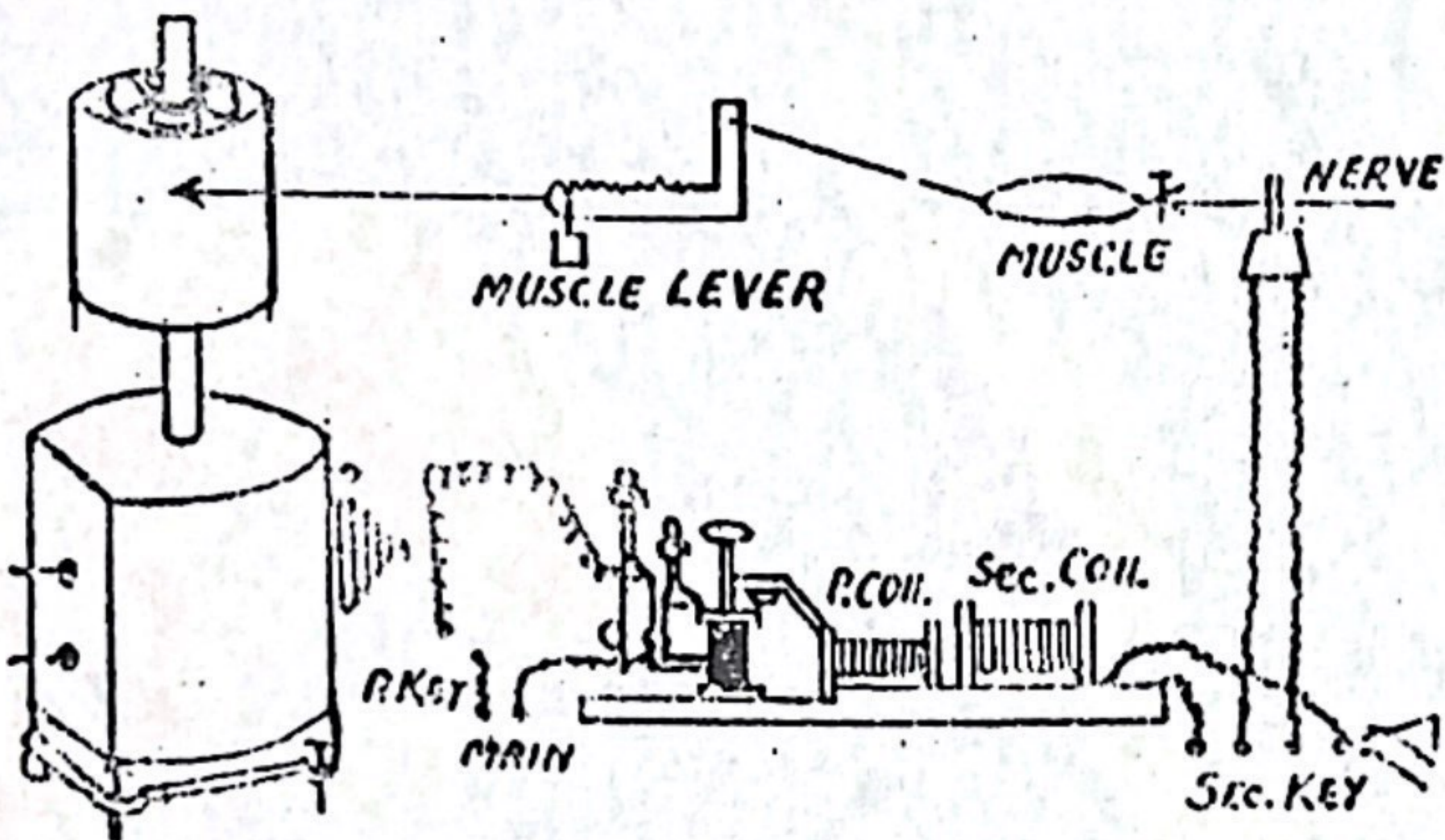

Fig. 18. Circuit B.

Circuit C

Drum included in primary circuit and the use of Pohl's commutator in secondary circuit.
ELECTRODES

This circuit is used in the detection of velocity of nerve impulse where in two pair of electrodes are used. Pohl's commutator is used to select any particular electrode pair for stimulation.

Drum is included in the primary circuit. Pohl's commutator is used instead of the short circuiting key. Four terminals out of six of Pohl's commutator are connected to two pairs of electrodes and the other two with the secondary coil of the induction coil. In this arrangement two stimuli are given. Each pair of electrodes gives a separate response on the same base line. Comparing this with the distance between the electrodes the velocity in the nerve can be calculated.

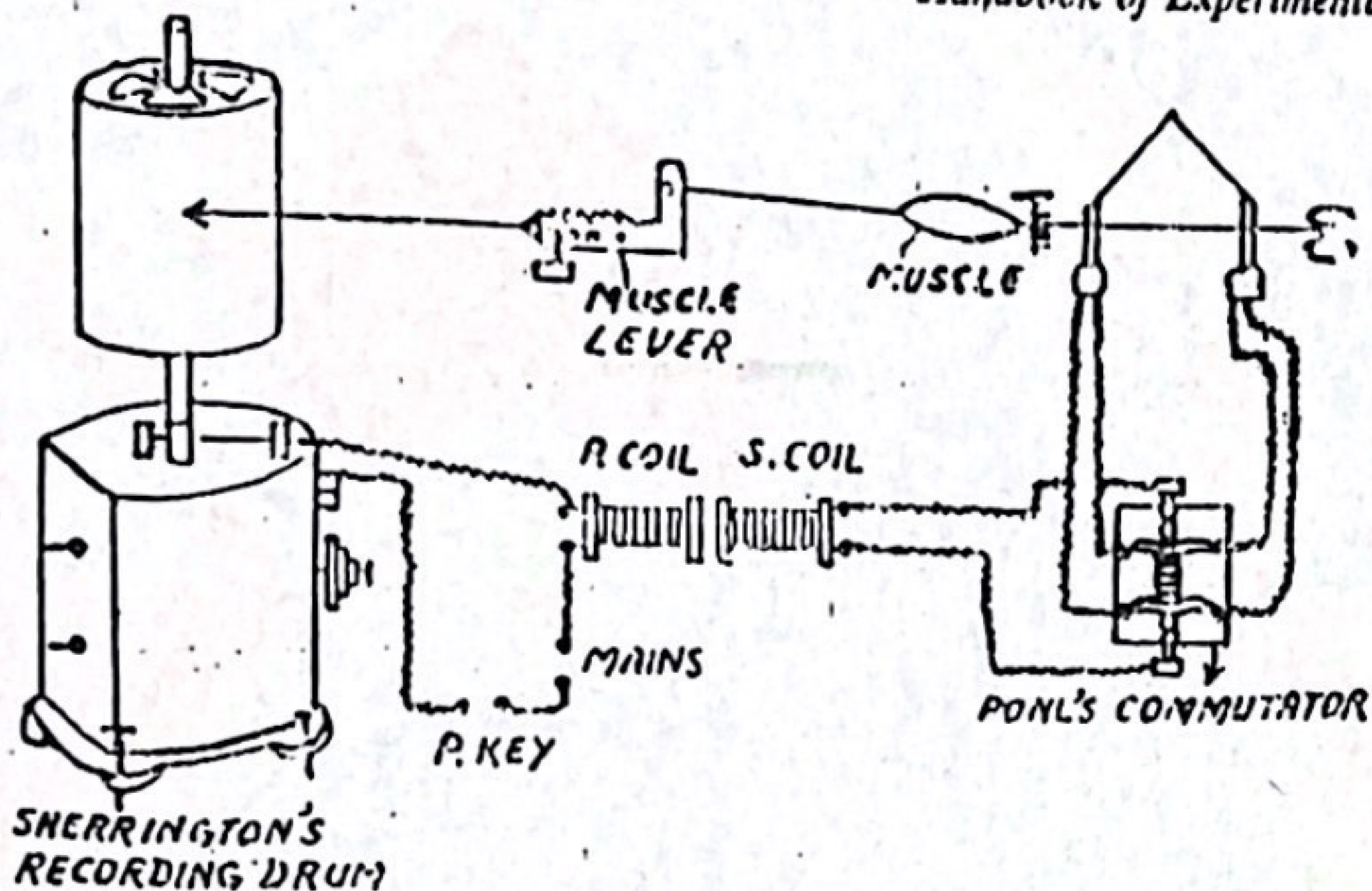

Fig. 19. Circuit C.

Circuit D

Drum excluded from primary circuit and substituted by tetanus set for multiple make and break shocks:

This circuit is used for multiple make and break shocks. It is used in experiments like 'Genesis of Tetanus'. The drum is excluded from the primary circuit and tetanus set is added.

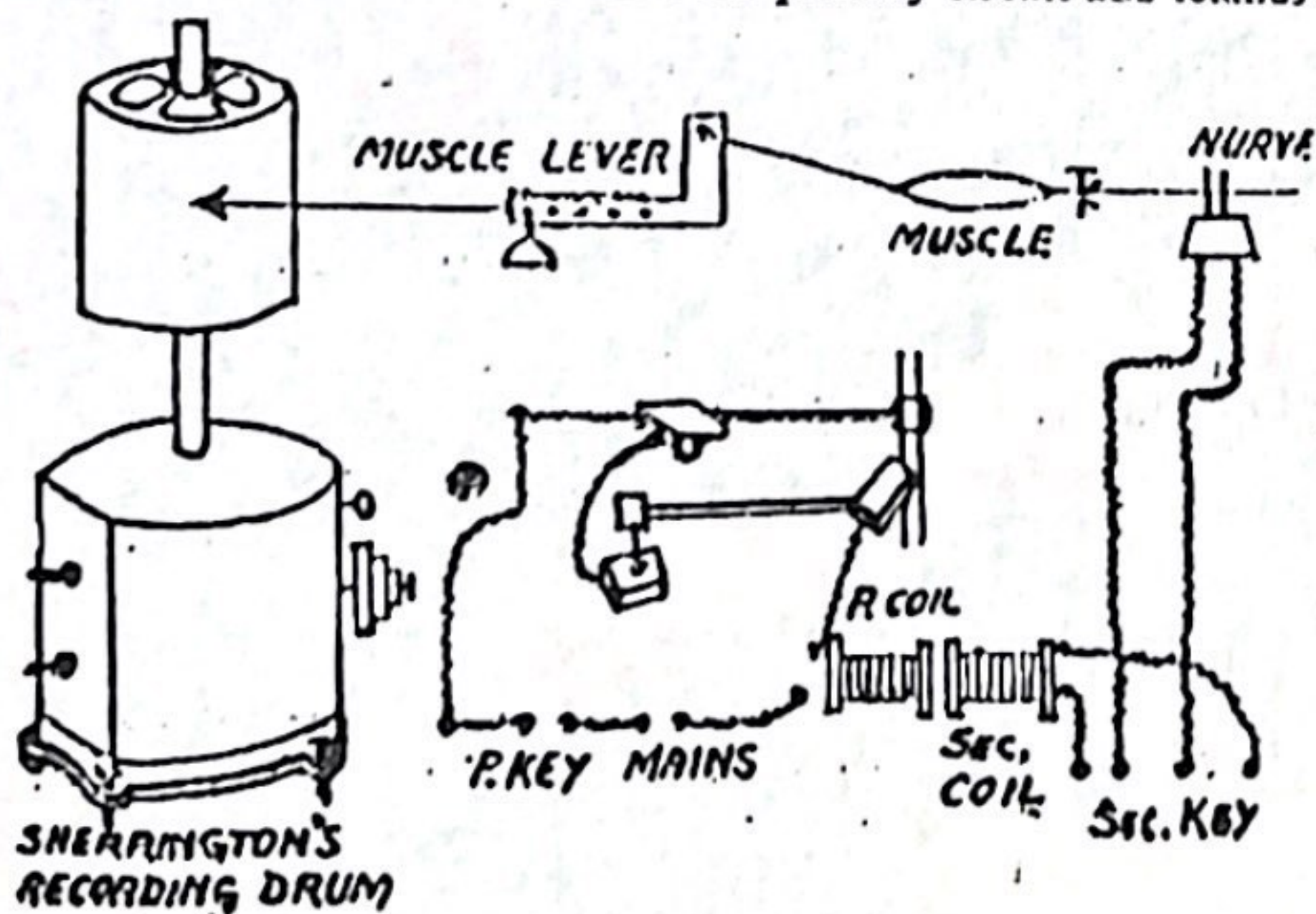

Fig. 20. Circuit D.

Circuit E

Drum excluded from primary circuit and substituted by Electromagnetic Signal marker.

The electromagnetic signal is useful in indicating the 'make' and 'break' of the circuit. The 'make' is indicated by a downward movement of the electromagnetic signal and the break

Electrical Circuits

with the upward movement of the signal. This circuit is used in the gradation of stimuli and in the heart experiments.

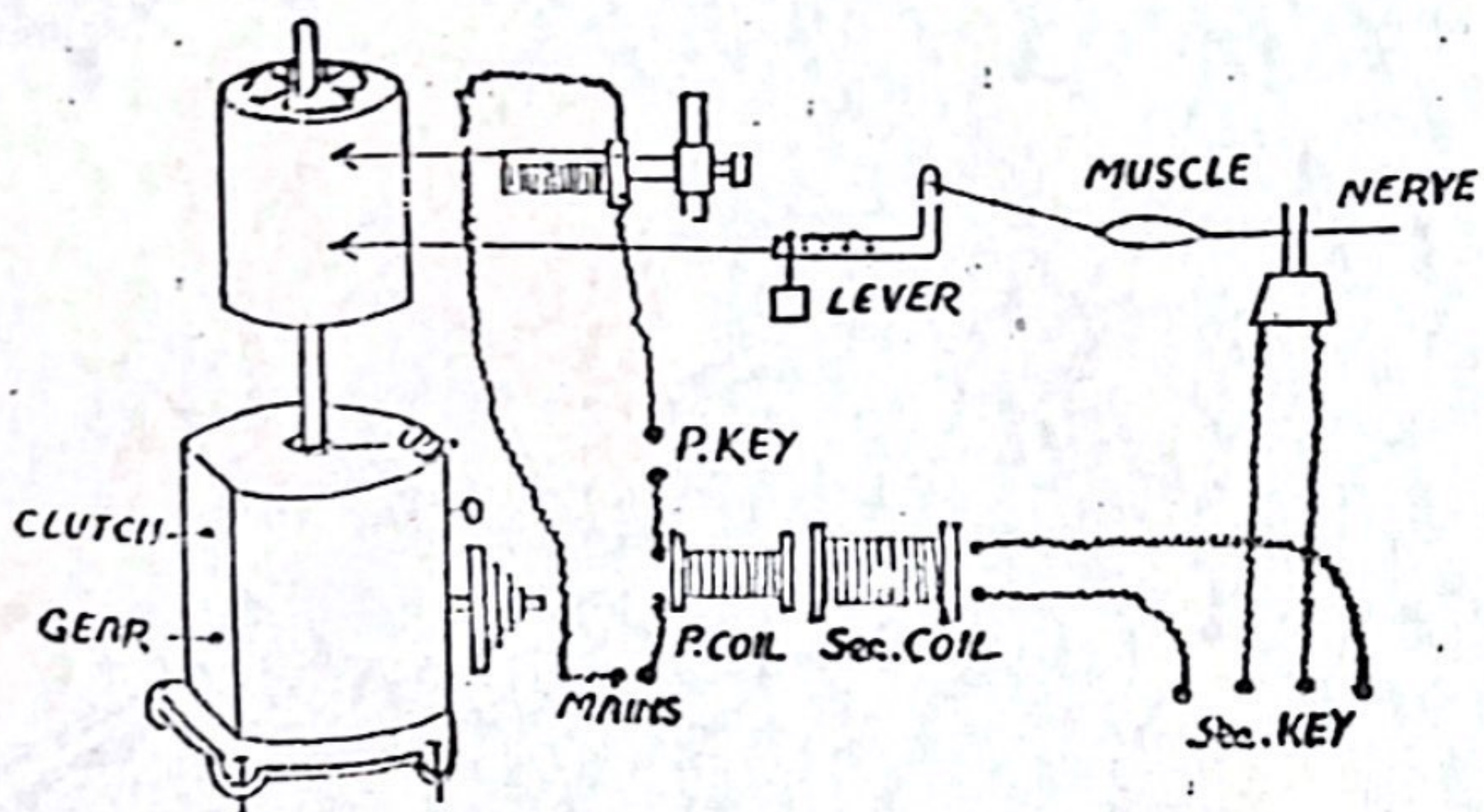

Fig. 21. Circuit E.
Nerve Muscle Preparation

Pithing of a Frog

The essential steps are :

1. Wash the frog to clean the mucoid materials.
2. The frog is caught by the left hand from the vertebral column.
3. With the index finger of the left hand the nose is pressed so that it makes almost a right angle to the vertebral column.
4. A point is detected exactly in the centre of a line joining horizontally the two tympanic membranes. This is a depression, where a stout needle should be pushed in. Thereafter it is pushed inside the vertebral canal towards the lower side.
5. The needle is rotated in all directions to destroy the spinal cord properly.
6. Due to the destruction of the spinal cord the limbs become flaccid. Initially some movements of the legs may be seen due to irritation of the spinal cord.
7. Bring out the needle from the spinal cord and retest the flaccidity of the lower limbs.
8. Any bleeding occurring can be stopped by pressure with cotton.
9. The frog is ready for dissection.

Dissection

Cut the pithed frog across about 1 cm. anterior to the Sacro-iliac joints—remove any viscera remaining in the body cavity. Cut the skin between the legs. Grip the skin at the transverse cut with the finger and thumb of one hand and the end of the spinal column with the other and pull the skin downwards towards the toes—it will pull off easily and cleanly. The second leg is left covered with skin.

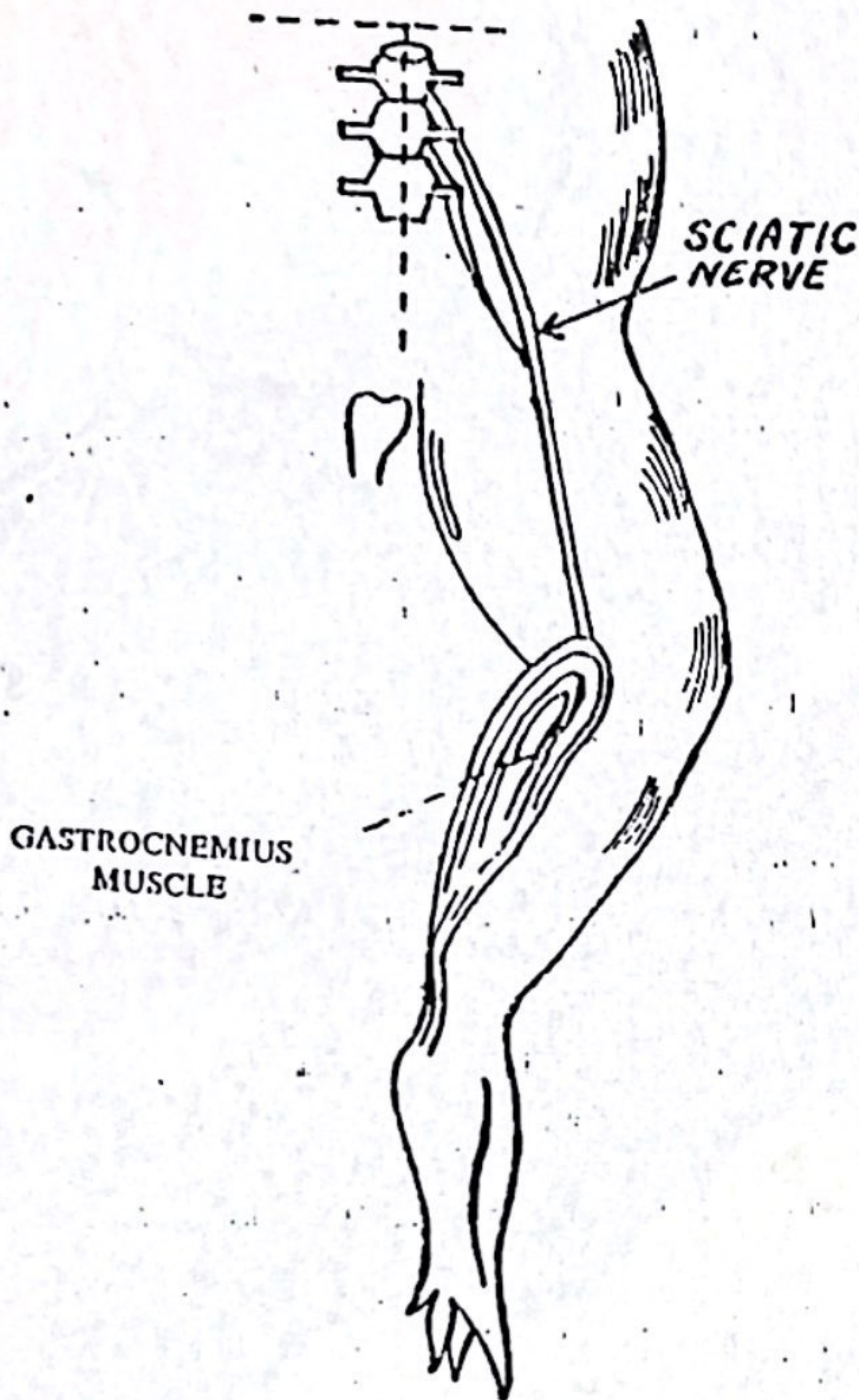

Fig. 22. Dissection.

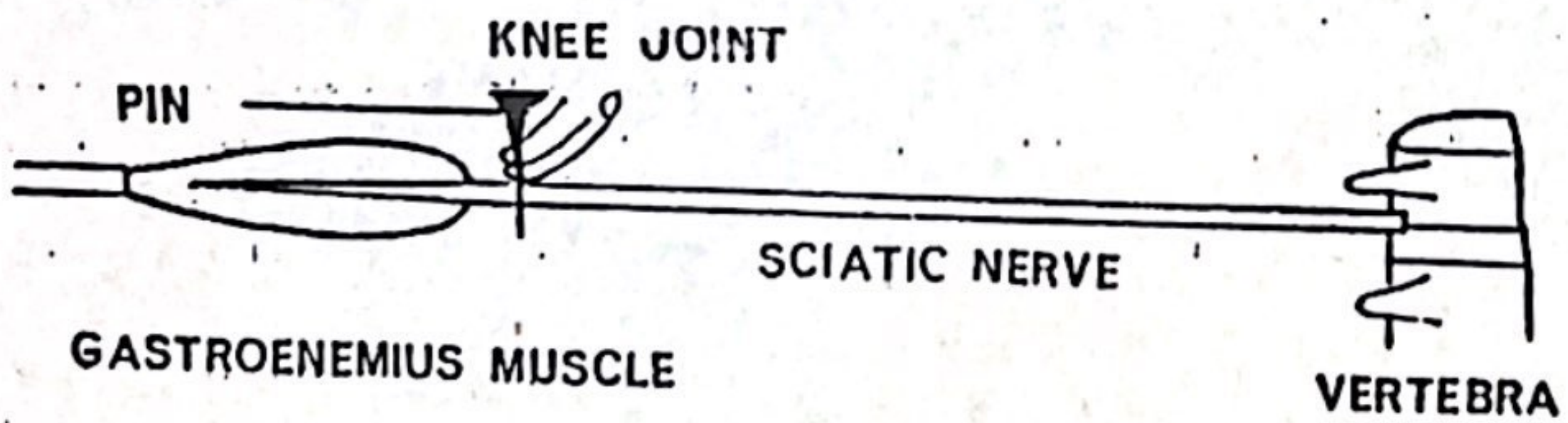

Fig. 23. Nerve muscle preparation.

Electrical Circuits

Lay the legs on their ventral surface, grasp the urostyle with forceps, and remove it by cutting away the muscle on both sides, and finally cutting it away from the end of the spinal column. Turn the preparation into the dorsal surface and observe the origin of the sciatic nerves lying against the back of the abdominal cavity.

Snip through the sacro-iliac joint on the side of the skinned leg; bisect the end of the spinal column. Longitudinally, by means of one strong steady cut with scissors, carefully, avoiding injury to the nerves. By holding the pieces of vertebrae thus isolated the dissection of the nerve can be carried out without pinching it with forceps. Handling with metallic forceps is likely to damage the nerve.

Again lay the preparation on the ventral surface and pin firmly to the dissection board.

Holding the piece of bone with forceps, dissect the nerve down towards the thigh separate the muscular masses on the dorsal side of the thigh carefully, looking for the sciatic nerve and artery lying side by side; continue the dissection nearly to the knee; do not, let the nerve lie on the skin of frog; moisten with frog's Ringer saline, if necessary. Tie a ligature round the tendo Achillis, cut this on the distal side, snip through the connective tissue attaching the gastrocnemius muscle to the leg. Cut through the leg bone just below the knee. Remove the whole thigh just above the knee, taking care to leave the gastrocnemius muscle and sciatic nerve intact. Do not try to dissect the nerve at the knee.

The nerve muscle preparation is now complete, consisting of vertebrae with origins of sciatic nerve—sciatic nerve—knee joint—gastrocnemius muscle—tendon and thread.

It is fastened on the myograph board with a pin through the knee joint. Attach the thread to the vertical and raised arm of the level so as to just stretch the muscle. On no account the muscle should be loosely fixed otherwise there would not be much change in the movement of the lever with contractions of the muscles.

Advantage of the preparation :

1. These tissues can function without blood supply when kept in a proper solution or if the solution is continually poured over it. Ringers solution is the most satisfactory for such purpose.
2. The oxygen is derived from the air by the process of diffusion.
3. The preparation is convenient to prepare.

Simple Muscle Curve

Object. To demonstrate the effect of a single (induced) shock to the muscle-nerve preparation and to calculate the time period of the various phases of muscle contraction obtained.

Or

To demonstrate a simple muscle curve on a muscle-nerve preparation and calculate the time of different phases.

Apparatus. The primary circuit apparatus consists of 6 volts D.C. Primary key, primary induction coil, recording drum. The secondary circuit apparatus consists of : Secondary induction coil, short circuiting key, muscle nerve electrodes, myograph board, myograph level and the muscle-nerve preparation.

Circuit. Primary circuit. One of the terminals of the primary coil of the induction coil is connected to the drum terminal. The other terminal of the primary coil is connected to the one terminal of 6 VDC source (the primary source of electric current). The other terminal of DC source is connected to one of the terminals of primary key. And the other terminal of the primary key is connected to the other terminal of the drum.

Secondary circuit. The terminals of the secondary coil of induction are connected to the outer two terminals of short circuiting key the two inner terminals of which in turn are connected to the Electrodes. The electrodes are in direct contact with the nerve.

Speed of drum. Fastest.

Stimulus. Minimal.

Procedure

(1) A nerve muscle preparation is prepared as described in the introductory chapter.

(2) It is transferred to the myograph board and fixed.

(3) The after screw should be just made to touch the lever.

The lever should be horizontal and is brought in gentle contact with the drum first tangent position to drum. (This results in completing the primary circuit with the primary key open). Move the lever up and down by your fingers to see that it gives a uniform line. Otherwise drum is levelled by spirit level to ensure a proper line. By this you can also know that the lever has not pressed hard over the drum so as to hinder free movements.

Simple Muscle Curve

- (4) Since minimal stimulus is desired the distance of the primary and secondary coils of the induction coil should be adjusted. It should be kept in mind that the 'break' should be only effective.
- (5) The drum should be allowed to move and a clean base line obtained. The primary key should be closed.
- (6) During the next revolution the short circuiting key is opened and immediately closed as soon as the muscle twitch is over. A simple muscle curve is obtained on the drum.
- (7) The lever is rotated away from the drum. (The drum is removed away from the lever). The primary circuit is broken by opening the key.
- (8) The point of stimulus is marked on drum at the point where the contact pin is pressing the knob

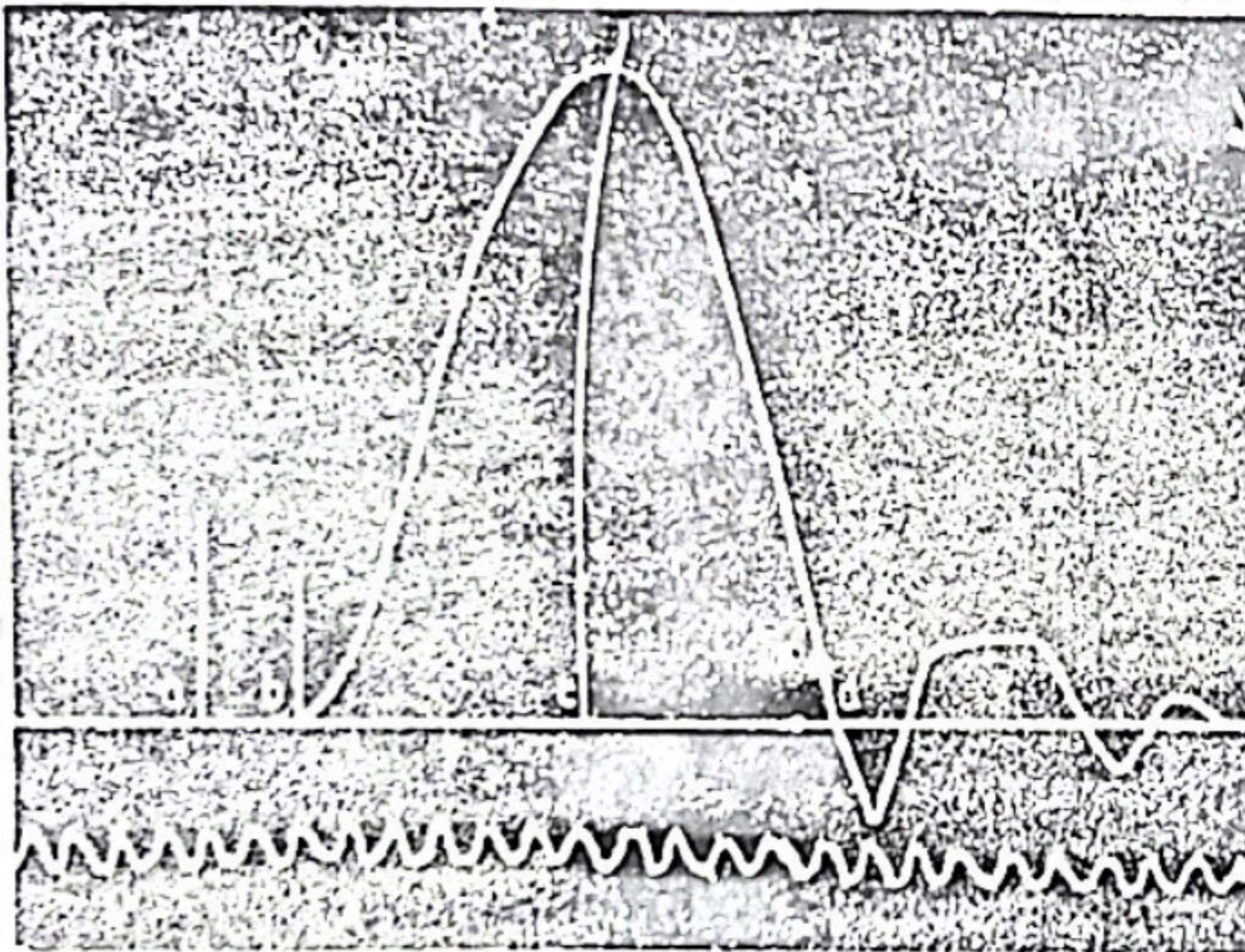

ab : Latent period.

bc : Contraction period.

cd : Relaxation period.

Fig. 24. Simple muscle curve.

- (9) Points to be marked are: Point of stimulation, point of onset of contraction, point of beginning of relaxation, point of completion of relaxation before removing drum from set.
- (10) The drum is restarted at same speed and the vibrations of a known tuning fork are recorded. (e.g. 100 vibrations per second). This recording should be below the base line. The distance between the top of one gyration to the top of another measures 0.01 Second.
- (11) Time intervals are measured by calculating the no. of waves and then by multiplying with 0.01 Second.

Relevant Questions

(1) What are the types of stimuli which could be used for the stimulation of the Nerve muscle preparations.

The Nerve-muscle preparation is mounted on the myograph board and the following types of stimuli could be used :

(i) Mechanical :

This type of stimuli could be obtained by pinching or tapping the nerve with some light instrument e.g. forcep. A twitch like contraction is obtained by the muscle action.

This is because of the conduction of the mechanical stimulus via the nerve to the muscle.

The muscle could be pinched directly and the contraction observed.

(ii) Thermal stimuli :

A metallic hot or cold wire should be touched to the nerve and the contraction of the muscle observed.

(iii) Chemical stimulus :

A mild Acetic Acid should be poured over the muscle and the contraction observed.

(iv) Osmotic stimulus :

A drop of highly concentrated saline or glycerine brings about changes in the osmotic pressure resulting in the water withdrawal from the nerve. A contraction of the muscle is observed.

(v) Unipolar stimulus :

In primary circuit an interrupter is introduced and the short circuiting key in the secondary circuit omitted.

(vi) Galvanic current stimuli.

(vii) Faradic current stimuli.

(viii) Stimuli by drying.

(2) What is the inference drawn from the experiment ?

When a muscle contracts isotonicly by an adequate stimulus it represents three phases :

(i) Latent phase.

(ii) Contraction phase.

(iii) Relaxation phase.

Latent phase is the duration between the point of stimulation and the beginning of the curve. The average duration is 0.01 second. Contraction phase is the duration between the beginning of rise of the curve and the peak of the curve. The average duration is 0.05 seconds.

The total time period of a simple muscle curve is 0.1 second.

(10) What is microscopic structure of muscle cell ?

A living muscled fibre is composed of alternate transverse dark and light bands due to zones of higher and lower refractive index respectively. Bands of high refractive index are birefringent or anisotropic called 'A' band and bands of low refractive index are isotropic called 'I' bands.

(11) What is the chemical composition of the muscle ?

Chemically the muscle is composed of :

- (i) Water.
- (ii) Protein—Myogen, Actomyosin, Globulin, Strome proteins.
- (iii) Glycogen.
- (iv) Lactic acid.
- (v) Phosphorus compounds (A.T.P.).
- (vi) Fat.
- (vii) Enzymes.
- (viii) Inorganic salts.

(12) What are the contractile proteins of muscles ?

The contractile proteins of the muscles are :

- (i) Actin.
- (ii) Myosin.
- (iii) Tropo myosin,
- (iv) Troponin.

(13) What is the composition of Ringer's solution ?

The composition of Ringer's solution is :

NaCl : 0.6 gms.

CaCl₂ : 0.01 gms.

KCl : 0.0075 gms.

NaHCO₃ : 0.01 gms.

distilled water to make is upto 100 ml.

(14) What is the chief utility of Ringer's solution ?

The Ringer's solution is Isotonic with the tissues of the frog and therefore can be extensively used in experiments where frog tissue is used.

(15) What is the Isotonic solution for mammals ?

It is 0.9% of sodium chloride solution.

(3)

Effect of two Successive Stimuli on Nerve Muscle Preparation

Object. To demonstrate the effect of two successive stimuli on a frog's muscle-nerve preparation.

Apparatus. The primary circuit apparatus consists of a recording drum, primary coils of the induction coil, primary key and the 6 volts DC source. The secondary circuit apparatus consists of secondary coils of induction coil, short circuit key, electrodes, a nerve muscle preparation (with instruments of dissection).

Circuit. The same as used for simple muscle curve.

Speed of drum. Moderate speed.

Strength of stimulus. Sub-maximal.

Procedure

(1) A nerve muscle preparation is described in the introductory chapter.

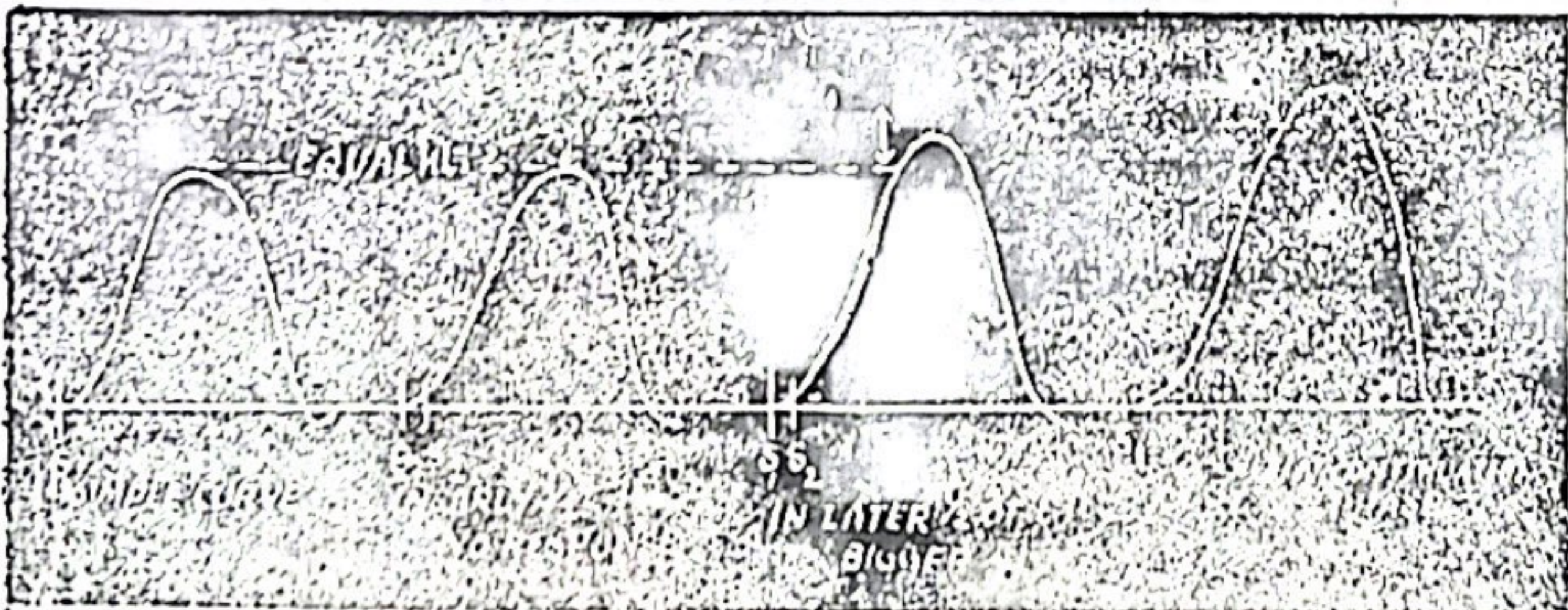

Graph 1

Graph 2a

Graph 2b

Graph 3

Graph 1 shows a simple muscle curve.

Graph 2a and 2b shows the second stimuli in early and later half of latent period.

Graph 3 shows second stimulus in contraction phase.

Fig. 31.

- (2) The primary and secondary circuits are rechecked.
- (3) A simple muscle curve is taken on a base line. Time tracing is also taken.
- (4) All the following graphs are taken separately on different lines and different points of stimulus.
- (5) The contact (arms) of the drum are adjusted so that two stimuli in quick succession are applied to the muscle. The contact arms are gradually separated so that second stimulus falls in the latent period in one case (as shown in Graph 2), in contraction phase in second case (as shown in Graph 3), in relaxation phase in third case (as

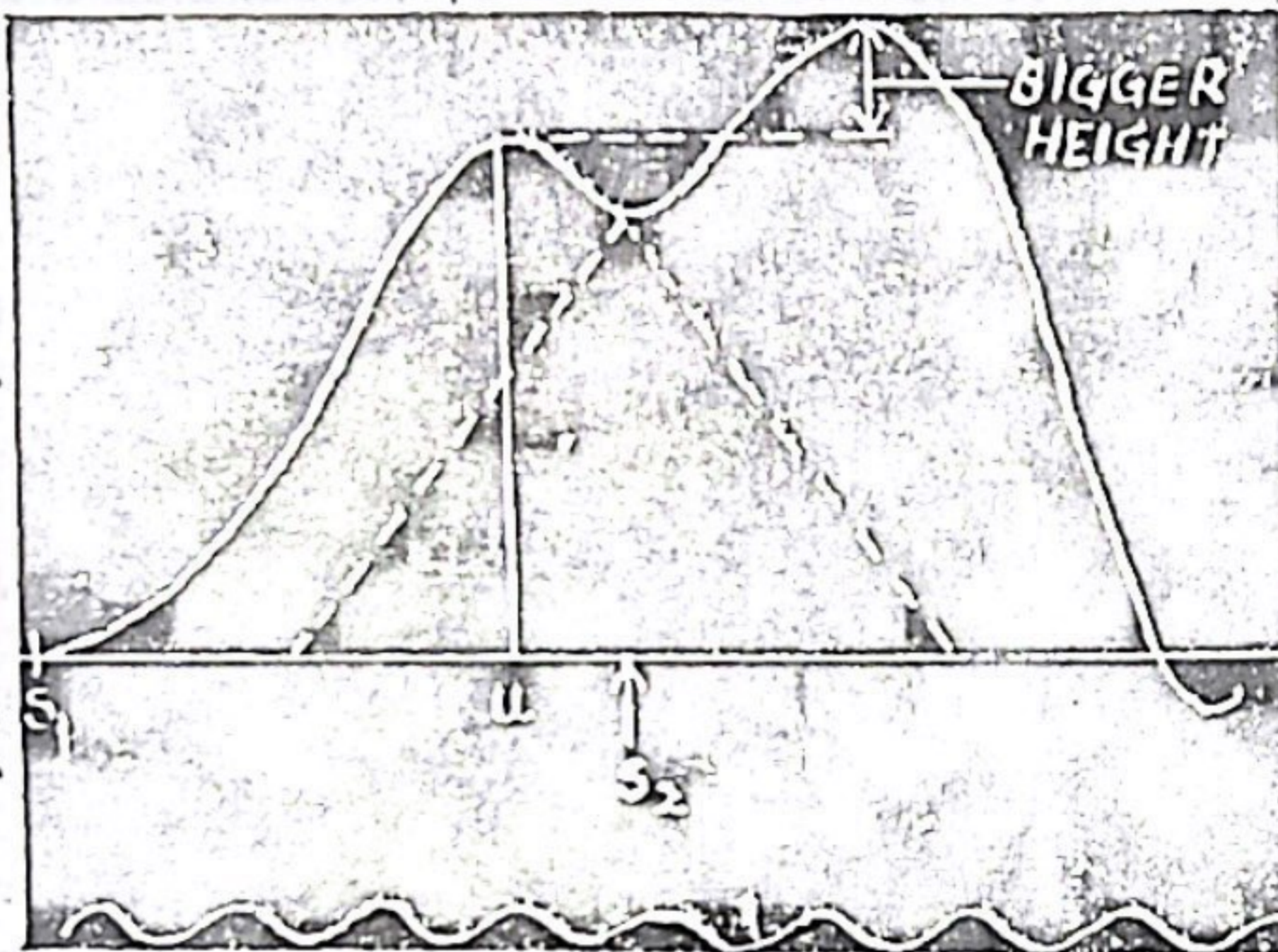

Graph 4

Fig. 32. Graph 4 shows second stimulus in the relaxation phase.

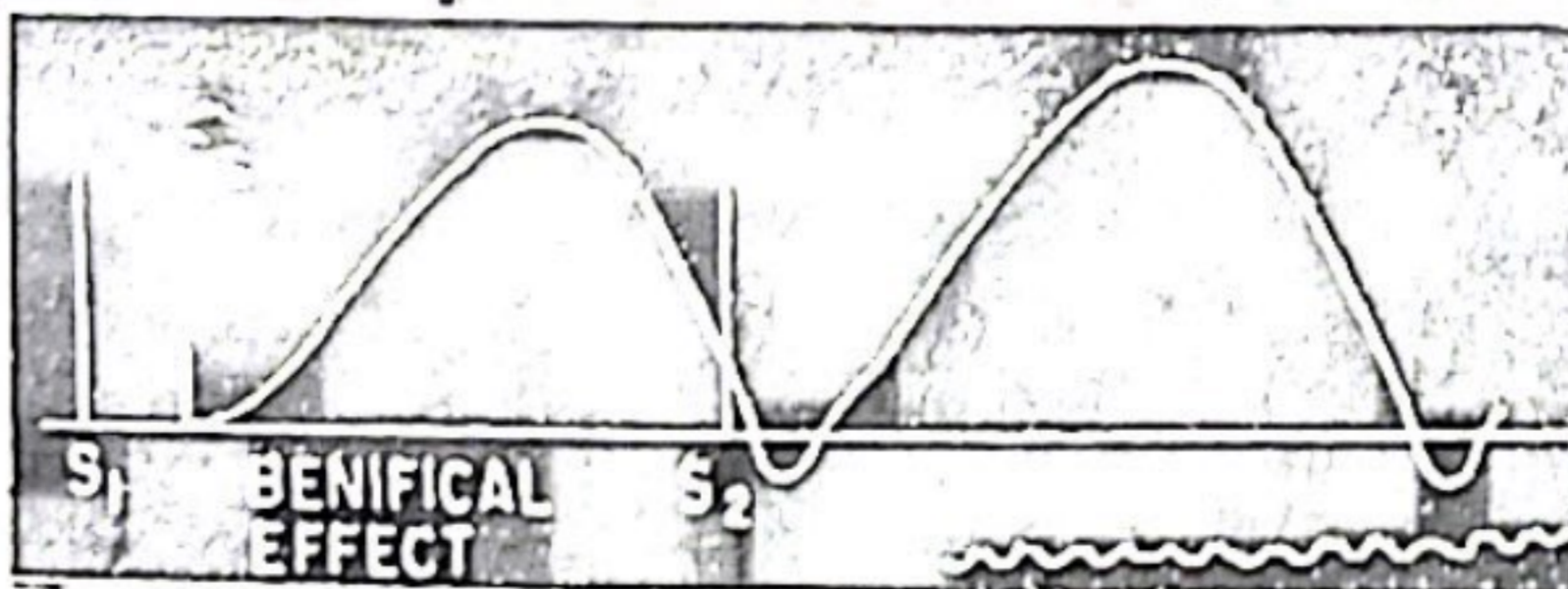

Graph 5

Fig. 33.

Effect of Two Successive Stimuli on Nerve Muscle Preparation

shown in Graph 4) and after the immediate completion of relaxation phase in the fourth case (Graph 5).

(6) The tracing is taken for each graph.

Relevant Questions

(1) What are your observations of the graph?

Graph 2.. Shows the effect when the second stimuli falls in the latent period of the first stimulus. The Graph is just like a simple muscle curve but it is bigger as shown in comparison with Graph 1.

Graph 3. Shows the second stimulus being applied in the contraction phase of the first stimulus. This results in much bigger response.

Graph 4. Shows the second stimulus being applied during the early relaxation phase of the first stimulus.

Graph 5. Shows that the second stimulus is applied in the late relaxation period or immediately after the relaxation phase of the first. Two separate curves are obtained but the second one is bigger than the first.

(2) What is summation of stimuli?

When the second stimulus falls in the second half of the latent period of the first stimulus, the effect is a bigger curve. This effect is known as summation of stimuli.

(3) What is summation of effects?

When the second successive stimulus is applied to a muscle during the contraction phase of the first stimulus the effect is a much bigger curve. This effect is known as Summation of effects or Summation of contraction.

(4) What is beneficial effect of the previous contraction?

When the second stimulus is applied after the completion of relaxation phase, there is change in excitability and viscosity of muscle because of the first stimulus or the second resulting in increase in height of second contraction. This is known as beneficial effect of the previous contraction on the following contraction.

(5) What is the probable cause of the beneficial effect of the previous contraction?

The causes are :

1. Rise of temperature in muscle.
2. Decrease in viscosity of the muscle.

3. Rise of H-ion concentration because of accumulation of acid metabolites.

(6) What will happen if two sub-minimal stimuli are successively applied to a muscle? When a single sub-minimal stimulus is applied to a muscle there is no response. But when two subminimal stimuli are applied, they summate and the muscle responds. This is known as summation of subminimal stimuli.

(7) What is summation of maximal stimulus?

Since all the muscle fibres are contracted when a maximal stimulus is applied, there is hence fourth no question of summation of maximal stimulus.

Effect of Several Stimuli on Nerve Muscle Preparation

Object. To demonstrate the effect of several successive stimuli on nerve-muscle preparation.

OR

To demonstrate the phenomenon of Genesis of Tetanus on nerve muscle preparation of frog.

Apparatus. The primary circuit apparatus consists of primary coils of the induction coil, signal marker, variable interrupter or Tetanus set. The secondary circuit apparatus consists of secondary coil of the induction coil, short circuit key, electrodes, myograph board, myograph lever and nerve muscle preparation with a set of dissection.

Circuit. The drum is excluded from the primary circuit. A variable interrupter of Tetanus set and signal marker is included in the primary circuit. The secondary circuit consists of secondary coils of induction coil, short circuit key and electrodes.

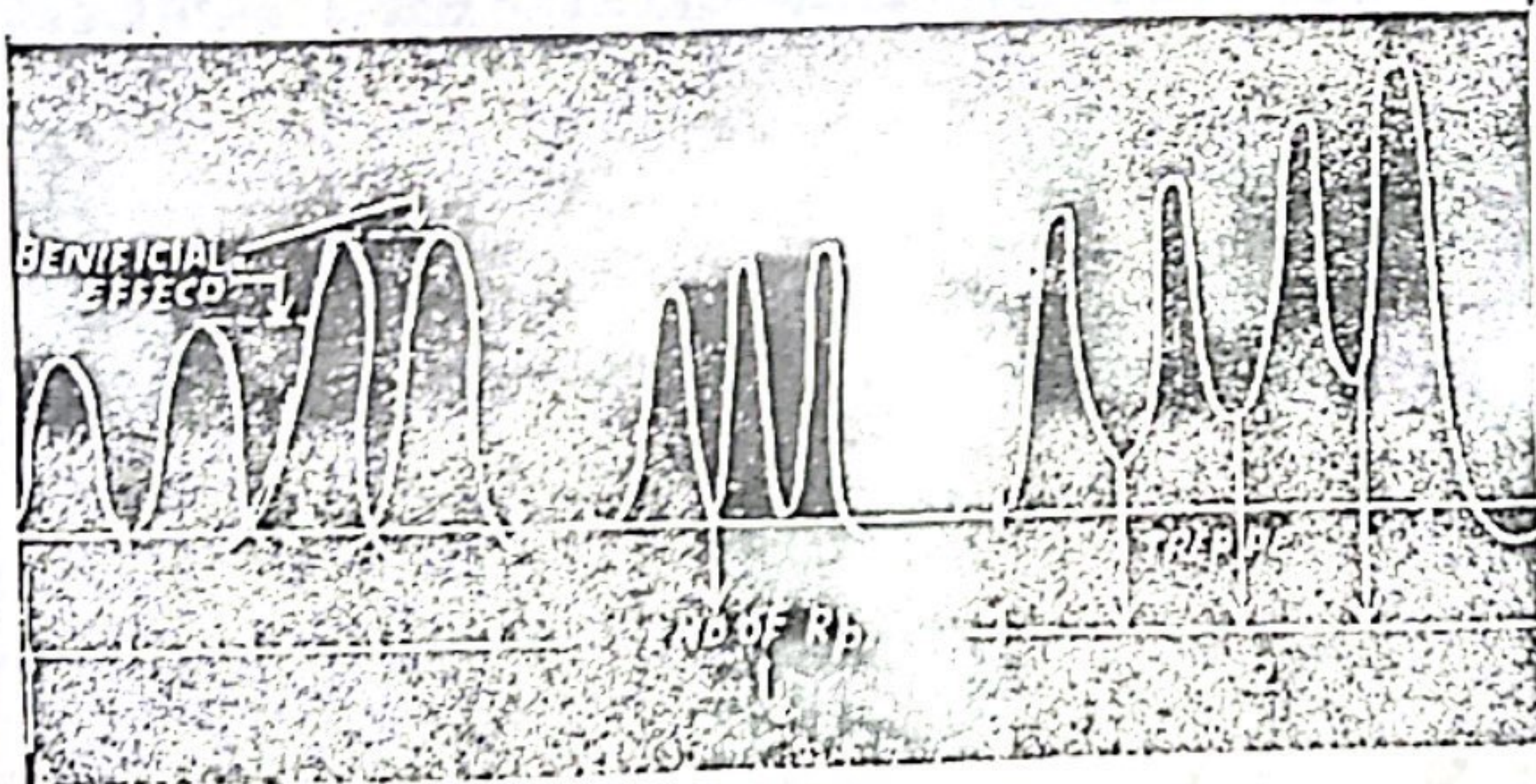

Graph 1 showing Staircase phenomenon

Graph 2 showing Treppe phenomenon

Fig. 34. Effect of successive several stimuli.

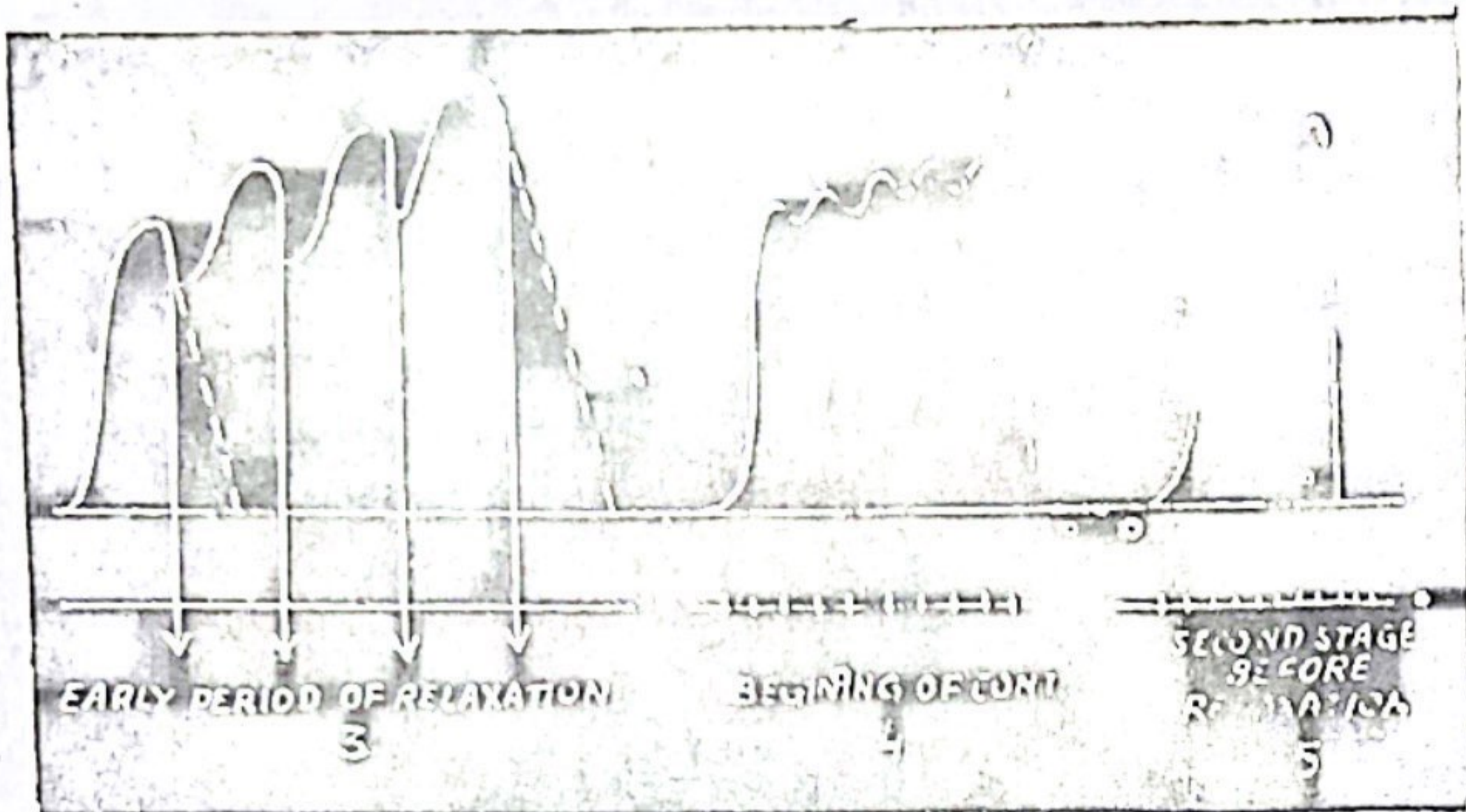

Graph 3 showing clonus phenomenon
Graph 4 showing incomplete tetanus
Graph 5 showing complete tetanus
Fig. 35. Effect of successive stimuli.

Speed of the drum : Slow.

Strength of the current used. Minimal stimulus.

Procedure

- (1) A nerve muscle preparation is prepared as described in the introductory chapter.
- (2) The primary circuit is inclusive of a variable interrupter/Tetanus set. Both the circuits are checked.
- (3) The length of the vibrating rod is adjusted according to the desired number, of stimuli per second by adjusting the length of a movable screw, when the screw is taken away the frequency of stimuli decreases and when it is pushed in a higher and higher frequency is obtained.
- (4) The base line is obtained and contractions are recorded with a gradual number of increasing stimuli. The usual frequencies are 5 stimuli/second ; 10 stimuli/second ; 15 stimuli/second ; 20 stimuli/second and 25 to 30 stimuli/second.
- (5) If a state of complete tetanus is not obtained, by Tetanus set the Neef's hammer may be used instead.
- (6) Tracings are fixed as usual.

Relevant Questions

- (1) What are your observations ?

When the successive stimuli are given at the rate of 5 per second (as shown in graph 1), then there appears a separate curve for each contraction, though with higher ampli-

Effect of Several Stimuli on Nerve Muscle Preparation

tude for each consecutive time. This is known as **Staircase phenomenon**. In this case every curve touches the base line but inertia lines of the lever are not seen. The subsequent contractions gradually increase to give a look of a stair.

When the frequency of stimulation is 10 per second (as shown in graph 2) the curves follow with quick succession with elimination of physiological curves. This is known as **Treppe phenomenon**. When the frequency of stimulation is about 15 second the first contraction is obtained followed by a heavy record, much above the base line. This effect is known as **clonus phenomenon**.

When the frequency of simulation is increased to about 20/second a sustained but flickering contraction is obtained. This phenomenon is known as **Incomplete Tetanus**.

Complete Tetanus is observed with a frequency of stimulation of 25-30 per second and a state of steady and sustained contraction is recorded on the graph.

To sum up the effect of successive stimuli are :

- | | |
|-----------------------------------------------------------------------|-----------|
| (i) Staircase phenomenon ; approx. frequency of stimuli 5 per second. | (graph 1) |
| (ii) Treppe phenomenon ; approx. frequency of stimuli 10 per second. | (graph 2) |
| (iii) Clonus phenomenon ; approx. frequency of stimuli 15 per second. | (graph 3) |
| (iv) Incomplete tetanus ; approx. frequency of stimuli 20 per second. | (graph 4) |
| (v) Complete Tetanus ; approx. frequency of stimuli 25-30/second. | (graph 5) |

(2) What is the principle of the experiment ?

When several stimuli are applied to a muscle with very little time gap (succession) the muscle exhibits a state of partial contraction or sustained contraction. The phenomenon of partial contraction is called incomplete tetanus and that of sustained contraction is called complete tetanus.

(3) In what phases of simple muscle curve of the successive stimuli fall in each of the above phenomenon ?

Staircase phenomenon. The successive stimuli fall after the relaxation phase of each contraction. Hence forth each contraction is recorded separately and 'Beneficial effect' observed in each contraction.

Treppe phenomenon. In this the successive stimuli fall immediately after the end of the relaxation phase.

Clonus. Here the successive stimuli fall in the relaxation phase, the consecutive contractions have a contraction phase with rise of the curve.

(4) What is the nature of voluntary contractions ?

Voluntary contractions are of tetanic nature if some muscle activity is expected to be sustained. Otherwise smooth actions are performed by co-ordinated and graded contractions of various voluntary muscles.

Phenomenon of Fatigue

Object. To demonstrate the phenomenon of fatigue and to prove the site of fatigue in the nerve-muscle preparation.

Apparatus. The primary circuit apparatus consists of recording drum, primary coils of the induction coil, primary key and mains. The secondary circuit apparatus consists of secondary coils of the induction coil, myograph board, myograph lever, short circuit key, electrodes, a nerve muscle preparation (with instruments of dissection).

Circuit. The same as used for simple muscle curve. (The drum is included in the primary circuit).

Speed of drum. Moderately fast.

Strength of stimulus. Minimal.

Procedure

- (1) The nerve-muscle preparation is prepared in the usual manner. It is fixed on the myograph board and lever.
- (2) The primary and secondary circuits are rechecked.
- (3) A simple muscle curve is obtained by stimulating the nerve.
- (4) Care is taken not to use Ringer's solution for washing of the nerve muscle preparation. Few drops may be added time to time only to keep the muscle-nerve preparation moist, because drying spoils the tissues.
- (5) The myograph board is moved a little away from the drum. About ten stimuli are given.
- (6) Myograph board is brought close to the drum, again a simple muscle curve is obtained.
- (7) In this manner every 11th contraction is recorded on the drum. Care is taken that the base line and point of stimulus remain the same.
- (8) Finally a separate base line is taken and the muscle is directly stimulated and the response obtained.
- (9) Time tracing is recorded for both the base lines.

Phenomenon of Fatigue

- (10) All the markings are made and the tracings are fixed as usual.
- (11) The heights of contraction, duration for latent period, contraction period and relaxation period are measured.

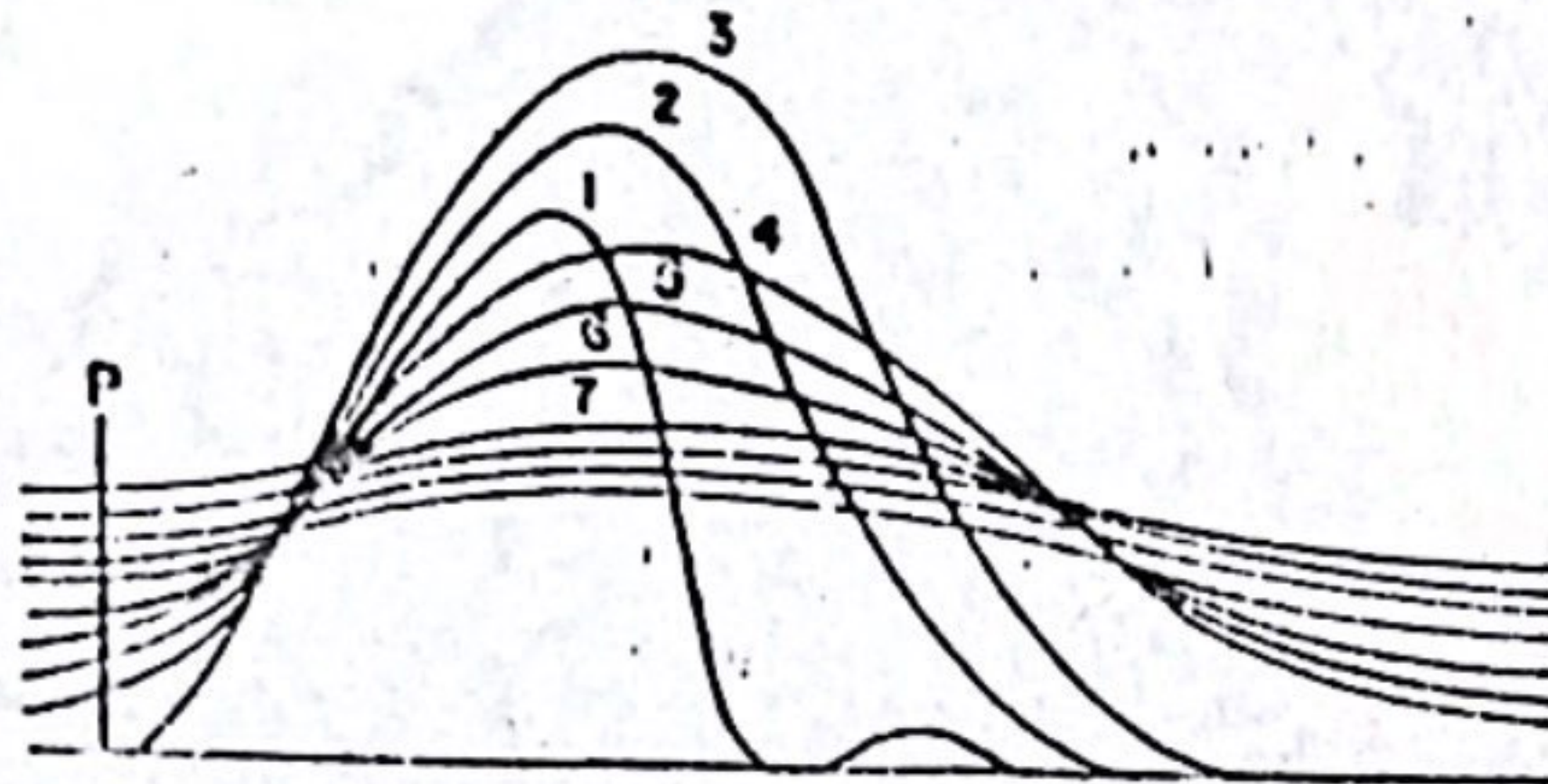

Fig. 36. Graph showing effect of fatigue.

Relevant Questions

- (1) What is the principle of the experiment?
After repeated stimulation of the muscle, through the nerve, there is a progressive deterioration in the force of the contraction, till a stage comes when there is no proper contraction recorded. When this stage is reached, fatigue is said to have set in.
- (2) What are the important precautions to be observed in the experiment? Give reasons.
 - (i) Ringer's solution should not be changed from the nerve muscle preparation during the course of the experiment. On adding Ringer's solution it washes away the metabolites, hence the possibility of recovery of the muscle and consequent hinderance in the development of fatigue, which is the object of the experiment.
 - (ii) During the dissection of the frog, mishandling to the nerve-muscle preparation should be avoided. This preparation should be as fresh as possible i.e., it should not be fatigued before the onset of experiment.
 - (iii) The point of stimulus and base line should remain the same.
- (3) What are the observations?
 - (i) Initially the height of contraction increases because of beneficial effects, then gradually it starts falling because of fatigue.
 - (ii) The durations of latent period, contraction period and relaxation period are prolonged.
 - (iii) Gradually contracture is observed; when the muscle contracts but fails to relax. The lower in such condition does not return to the base line.
 - (iv) A simple muscle curve is however recorded on the direct stimulation to the muscle which has shown complete fatigue when it was stimulated through the nerve.

(4) Define contracture.

Contracture is shortening of the muscle due to repeated stimulation resulting in incomplete relaxation phase.

(5) How does contracture differ from tetanus?

In contracture a few muscle fibres are affected resulting in decrease in length whereas in tetanus all the muscle fibres are contracted resulting in decrease in length of the muscle.

(6) Is contracture reversible?

If the muscle is given rest then it relaxes and the contracture disappears. Hence contracture is reversible.

(7) What is the cause of fatigue in muscles?

The probable causes of fatigue in the muscle tissue itself are :

(i) Lactic acid accumulation.

(ii) Depletion of energy to be used for resynthesis of A.T.P. And since A.T.P. is not available it fails to re-establish polarisation of the fibres.

The cause of fatigue in the neuro-muscular junction is depletion of acetylcholine which acts as chemical transmitter.

(8) What is the site of fatigue in the experiment?

Neuro-muscular junction is the first site of fatigue?

(9) How will you prove that muscle is not the first site of fatigue?

As shown in the experiment, the direct stimulation of the muscle gives a response even after the phenomenon of fatigue is obtained when the muscle is stimulated through the line. It indicates that muscle is not the first site of fatigue.

(10) How will you prove that nerve is not the first site of fatigue?

The nerve-muscle preparation (N-1; N-2) are fixed in such a manner that both are stimulated simultaneously. A piece of ice is kept on nerve just before the neuro-muscular junction on the N-2 preparation. It helps to stop the stimulation on the nerve itself.

Both the preparations are stimulated till the N-1 muscle does not contract i.e. the preparation is fatigued.

The ice piece is removed from the N-2 preparation and again both the preparations are stimulated. N-1 will not respond as obtained, but N-2 responds. This proves the nerve is not the seat of fatigue.

Nerves are considered infatigable due to low calorie value consumption.

(11) Is fatigue reversible? How will you demonstrate?

If the muscle is given rest and nutrition then fatigue is reversible. This can be conveniently demonstrated on the experiment. The fatigued preparation is allowed to

Phenomenon of Fatigue

rest (by detachment from the lever) and the Ringer's solution is changed frequently. Again the nerve is stimulated after 10–15 minutes, a response is observed, proving that fatigue is reversible.

(12) What factors influence fatigue ?

The factors which affect fatigue are :

- (i) The strength and rate of stimulus.
- (ii) Nutrition.
- (iii) Whether the muscle is 'free loaded' or 'after loaded'. Free loaded preparations fatigue early.

(13) What is the seat of fatigue in human body ?

The neuro-muscular apparatus in the body has four probable seats :

- (i) Muscle fibre.
- (ii) Neuro-muscular junction.
- (iii) Nerve cells of the Central Nervous System.
- (iv) Nerve fibres.

(14) What is the chemical composition of muscle ?

The important constituents are :

1. Water 70%
2. Protein 20%—Myogen Actomyosin, globulin and stroma protein.
3. Glycogen
4. Lactic Acid.
5. Creatine phosphate, A.T.P.
6. Fats, Enzymes, pigments and inorganic salts.

(15) What is the site of fatigue in severe muscular exercise ?

Muscular fatigue experience in severe exercise is due to events at the synapses in the central nervous system. This is considered to be a protective phenomenon. The central fatigue is manifested before there is any block at the neuro-muscular junction and long before the muscle has completely fatigued. Other factors like psychological motivation training action potential humidity and temperature affect muscular performance.

Effect of Temperature on Nerve Muscle Preparation

Object. To demonstrate the effect of temperature on muscular contractions.

Apparatus. The primary circuit apparatus consists of Primary coil of induction coil, Recording drum, Primary Key and the 6 V DC-volt source. The secondary circuit apparatus consists of secondary coil of the induction coil, Short Circuit Key, Electrodes myograph lever, muscle chamber, and instruments required to make a nerve muscle preparation.

Circuit. The same as used in the simple muscle curve.

Speed of drum: Fastest.

Stimulus. Minimal.

Procedure

- (1) A nerve muscle preparation is prepared as described in the introductory chapter. And it is fixed to the muscle chamber.

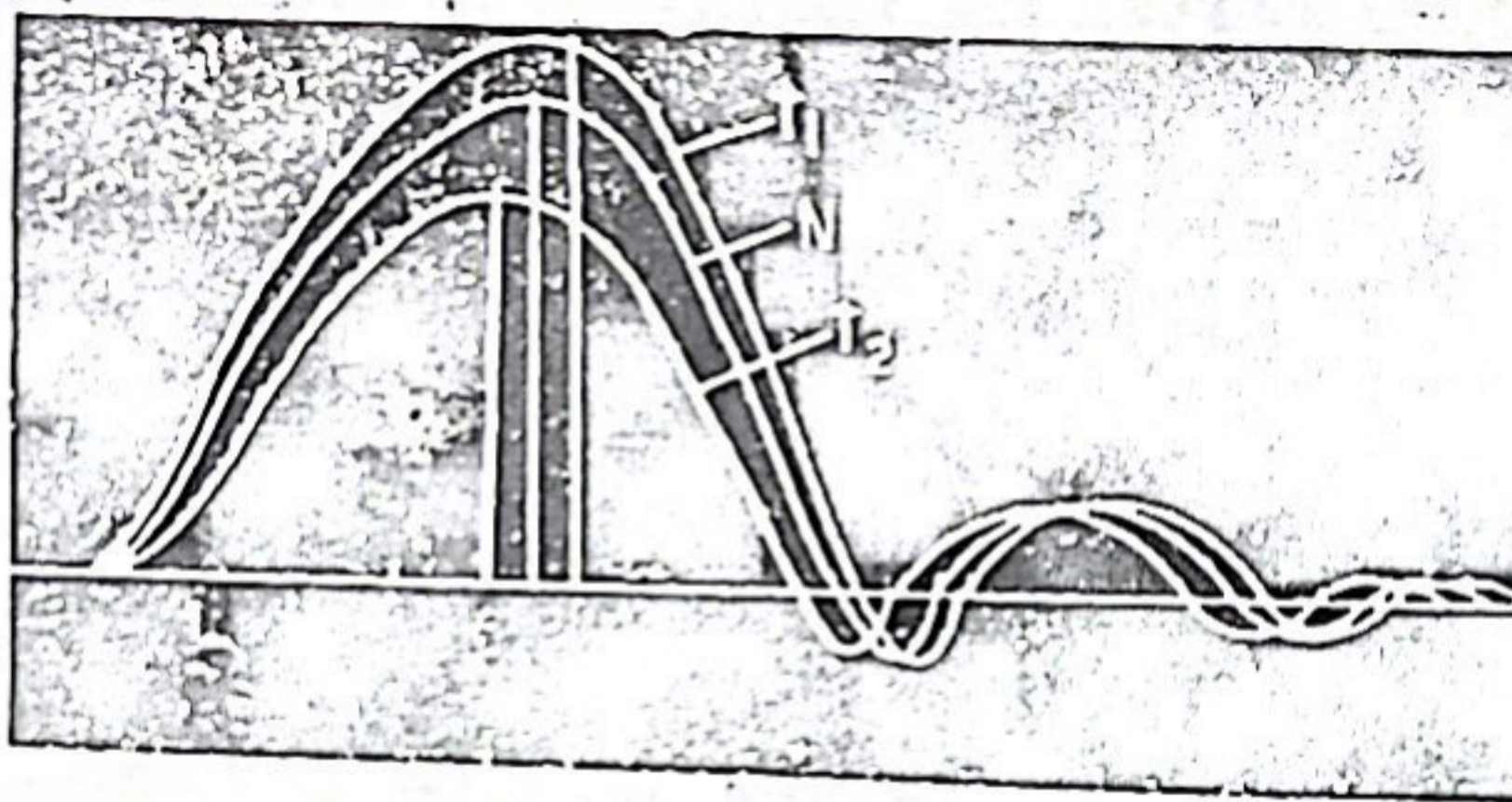

Fig. 25. Graph showing effect of temperature.
The arrow indicates the point of Stimulus.

N = normal

T₁ = with warm Ringer's solution (32°C)

T₂ = with cold Ringer's solution (18°C)

- (2) The primary and secondary circuits are checked.

- (3) Since a minimal stimulus is desired the distance of the primary and secondary coil is adjusted in such a manner that the 'break' is only effective.
- (4) The lever is tangentially brought close to the drum.
- (5) The drum is rotated and a base line obtained.
- (6) A simple muscle curve is obtained during the next revolution. The primary Key should be closed.
- (7) The Ringer's solution in the muscle chamber is replaced by Ringer's solution at a temperature 32°C . Temperature should not be high because it will damage the muscle tissues.
- (8) Wait for a few minutes and again take a simple muscle curve. The point of stimulation should be the same as that of simple muscle curve a room temperature 23°C .
- (9) Similarly a simple muscle curve is obtained with Ringer's solutions at 18°C in the muscle chamber. The point of stimulation and base line however, remain the same.
- (10) The point of stimulation, the peaks of curve and ends of curve points are marked.
- (11) A time tracing of known frequency is marked on the Kymograph.
- (12) The duration of latent phase, contraction phase and relaxation phase, of each curve is calculated from the wavy time marking.
- (13) Heights of contraction for each curve are measured.

Relevant Questions

- (1) What is the significance of the experiment?

The experiment is a demonstration of the facts :

The amplitude to the curve rises and it becomes steeper.

(a) When the muscle is stimulated at a temperature higher than room temperature the following effects are observed :

- (i) The latent period is reduced.
- (ii) The amplitude of the contraction phase is increased.
- (iii) The contraction and relaxation periods are affected to a variable extent but usually they are decreased. These are decreased if the lever has been jerked up to a greater height and therefore take a little longer time to return to the base.

(b) When the muscle is stimulated at cold temperatures, the effects are reverse i.e. there is increase in the latent period, contraction period and relaxation period.

The amplitude of the curve is less and it becomes less steep.

The lever may not return to the base line for an appreciable time at a temperature near 0°C .

Effect of Temperature

(2) What is the cause of above facts ?

The increase in temperature results in an :

- (i) Acceleration of the conduction of impulse.
- (ii) Acceleration of chemical changes and enzymatic processes in muscle and
- (iii) Possibly a decrease in the viscosity of the muscle which decreases the resistance to the sliding myofilaments. (i.e. actin and myosin).

All these factors are responsible for the shortening of latent period, contraction period and relaxation period.

The increase in amplitude is more of a mechanical effect due to quicker contraction of muscle.

These causes act in a reverse manner on fall of temperature.

(3) What are important precautions related to this particular experiment ? Explain :

The precautions of this experiment are :

- (i) The point of stimulus in all the contraction should be the same.
- (ii) Maximal induction shocks should be used in each contraction to avoid beneficial effect.
- (iii) The Ringer's saline used for temperature change of muscle should not be above 40°C and below 5°C .

Temperature above 40°C results in coagulation of muscle proteins resulting in heat rigor.

Moderate cooling of the muscle may in fact increase effectiveness of the stimulus, hence forth to avoid fallacious results a temperature below 5°C than room temperature should be obtained to demonstrate the effects of cooling on muscles.

- (iv) Wait for three or four minutes after Ringer's solution is changed in the muscle chamber. This helps in attainment of proper temperature by the muscle as that of Ringer, solution.

(4) What is heat rigor ? How can it be demonstrated in the experiment ?

Heat rigor occurs as result of coagulation of muscle proteins. The muscle chamber should be filled with Ringer's solution at a temperature of 45°C . A stimulus is given as before. A vertical line obtained on the Kymograph indicates heat rigor.

It is an irreversible change.

(5) What will happen to the muscle at Zero degree centigrade temperature ?

At Zero degree centigrade, there is loss of irritability and thus there is no contraction of the muscle.

SECTION TWO

FROG'S HEART

CONTENTS :

- 1) THE STRUCTURE OF THE FROG'S HEART
- 2) RHYTHMICITY AND CONDUCTIVITY
- 3) THE EFFECT OF TEMPERATURE AND PACE-MAKER
- 4) STANNIUS EXPERIMENTS
- 5) EXCITABILITY AND CONTRACTILITY
- 6) THE PERFUSION OF THE HEART

STRUCTURE OF FROG'S HEART

4

The main features of the heart beat can be studied on amphibian hearts as well as on the mammalian. The heart of the frog is more suitable, and easier in class experiments than the mammalian heart, which requires a large constant oxygen supply and a temperature similar to the body temperature. The amphibian hearts are much more resistant to experimental manipulation and on account of their comparatively slower chemical processes they can survive for a longer time outside the body. Many of the fundamental characteristics of the heart beat were discovered first in the frog and later proved to be correct also for the human heart.

The amphibian heart, e.g. frog, consists of:

1. Sinus venosus
2. Two auricles
3. One ventricle.
4. Truncus arteriosus.

It has no conducting bundle system and no coronary vessels. but receives its nutrition directly from the blood flowing within its chambers and has no Q wave in E.C.G. The mammalian heart has a conducting bundle system and coronary vessels.

The frog's heart exhibits 4 fundamental physiological properties, i.e.

1. Rhythmicity
2. Contractility
3. Conductivity &
4. Excitability.

All these properties are of purely myogenic origin, and neurogenic, i.e. the nerves control or modify but do not initiate the property.

Nerve Supply:

Three masses of nerve cells are embedded within the walls of the frog's heart, there are:

- 1) Remake's ganglion which lies in the walls of the sinus venosus

- 2) Ludwig's ganglion which lies in the walls of the auricles.
- 3) Bidder's ganglion which lies in the auriculo-ventricular junction.

The two vago-sympathetic nerves supply the heart, the vagus ending mostly at Remak's ganglion from which postganglionic fibres to the whole heart except the apex of the ventricle. The sympathetic fibres end at the whole heart muscle except the apex of the ventricle.

Some Characteristics of frog's heart :

1) Rhythmicity :

Sinus venosus beats 30/min. and ventricle at 8/min. at 20°C. The pace-maker is the sinus venosus.

2) Contractility :

Systole : is shortened by warming.

and prolonged by increase in initial length or force of contraction or bradycardia.

systole of dog's ventricle = 0.3 sec. and its auricles = 0.1 seconds; while frog's ventricle = 0.5 sec.

Relaxation Period : is from the end of systole till the return of the fibres to its original length. This period is not excitable to a threshold stimulus but is excitable to a stronger stimulus and the response is called an extra-systole.

Conductivity :

Compression of auriculo-ventricular junction produces a delay in conduction, then a state of missed beats or partial heart block, then a state of complete heart block, according to the intensity of compression.

Excitability :

The first stannius ligature stops the auricles and ventricle due to irritation of Remak's ganglion while sinus venosus beats normally. In the second stannius ligature, the ventricle beats according to its idioventricular rhythm.

RHYTHMICITY AND CONDUCTIVITY

5

Experiment One

Lay the pithed frog on its back on the frog board and fix it with 5 pins, four through the limbs and one through the jaw. Make a median incision through the skin over the sternum, raise the cartilagenous xiphisternum and separate it from underneath. Make an incision on each side of the cartilage; insert under the pectoral girdle the pointed blades of strong scissor, keeping the blade in close contact with the bone. Divide the girdle first on one side and then on the other side, raise and cut away the anterior wall of the thorax. Pull both fore-limbs laterally and fix them in such a position as to keep the chest widely opened.

a) Inspection of the Frog's Heart :

Slit open the pericardium. The ventricle is separated from the 2 auricles by the auriculo-ventricular groove. The truncus arteriosus opens into two aortae.

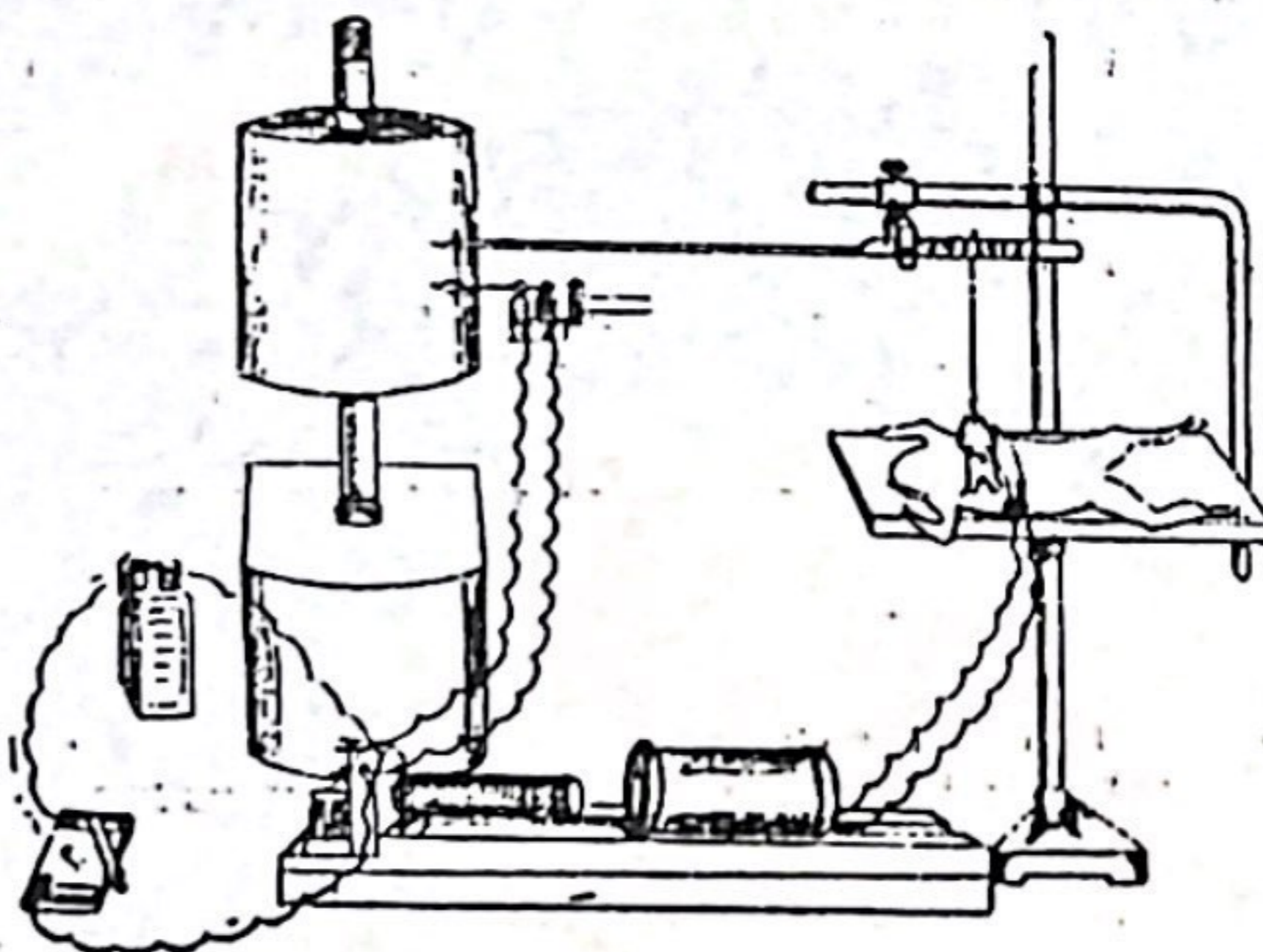

Fig. 15. — Arrangement for apparatus to stimulate the heart in situ with induction shocks; signal in the primary circuits.

Lift the ventricle up and find behind it the sinus venosus separated from the right auricle by a white crescentic line (sinoauricular junction). Find the deep blue two superior and the one inferior vena cavae entering the pulsatile blue sinus venosus. The auricles are purplish in color.

b) The Sequence of the Heart Beat:

The contraction of the 4 chambers of the frog's heart is not simultaneous. The sinus starts first and is followed by the auricles and then ventricle. The rhythm of the heart beat is dependant on the beat of the sinus. Watch the ventricle changing its colour during contraction, becoming pale when free from blood in systol. Note the short pause between the contraction of the sinus and auricles and between that of the auricles and the ventricle.

c) Record of the Heart Beat:

Pass a hook (made of a small pin) through the wall of the apex. Lift the heart very gently by the thread attached to the hook. Attach the thread to the heart lever at an appropriate distance from the fulcrum about one cm. so as to produce the best magnification. Record the movement of the beating heart on a slowly moving drum. Record the time below this curve. (See figure 15).

In successful tracings, the sinus (s), auricular (a) and the ventricular (v) beats are conspicuous.

Introduction to Heart Experiments

Instruments

The instruments used for experiments on the heart muscle are almost the same as described for nerve muscle physiology. A few additional instruments are as follows :

1. Starling's Heart Lever.

It consists of a metallic horizontal bar, with which there is a suspended fine spring. The other end of the spring is fitted with a stylus with a writing point. With the movement of the heart, the spring is moved up and down.

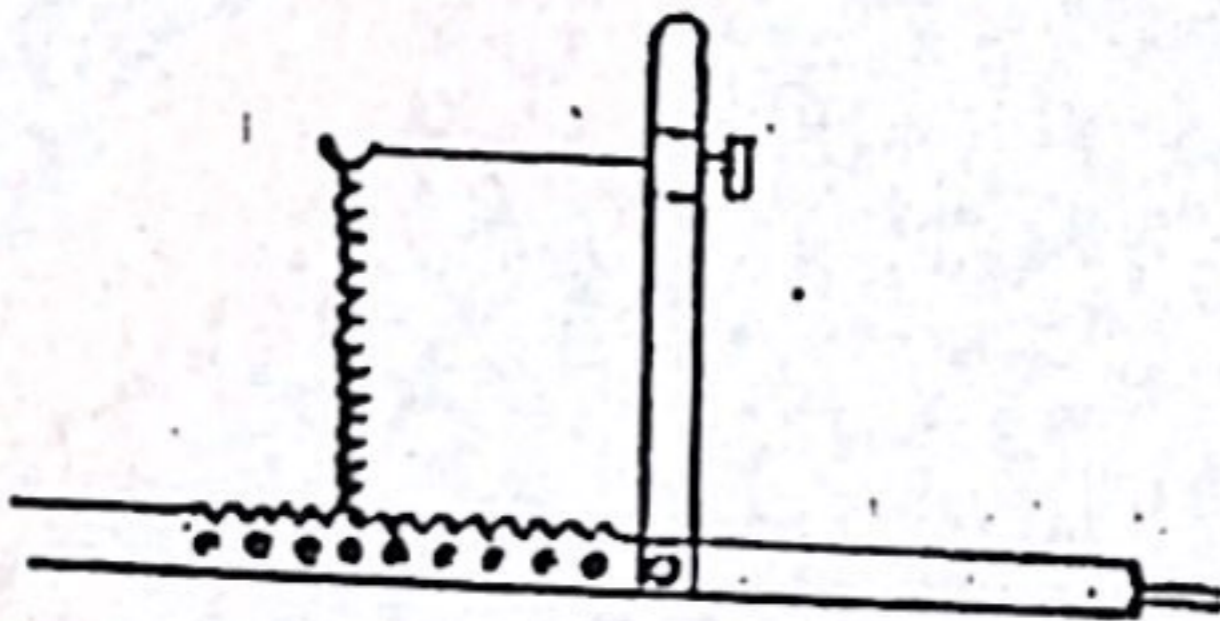

Fig. 38. Starling's heart lever.

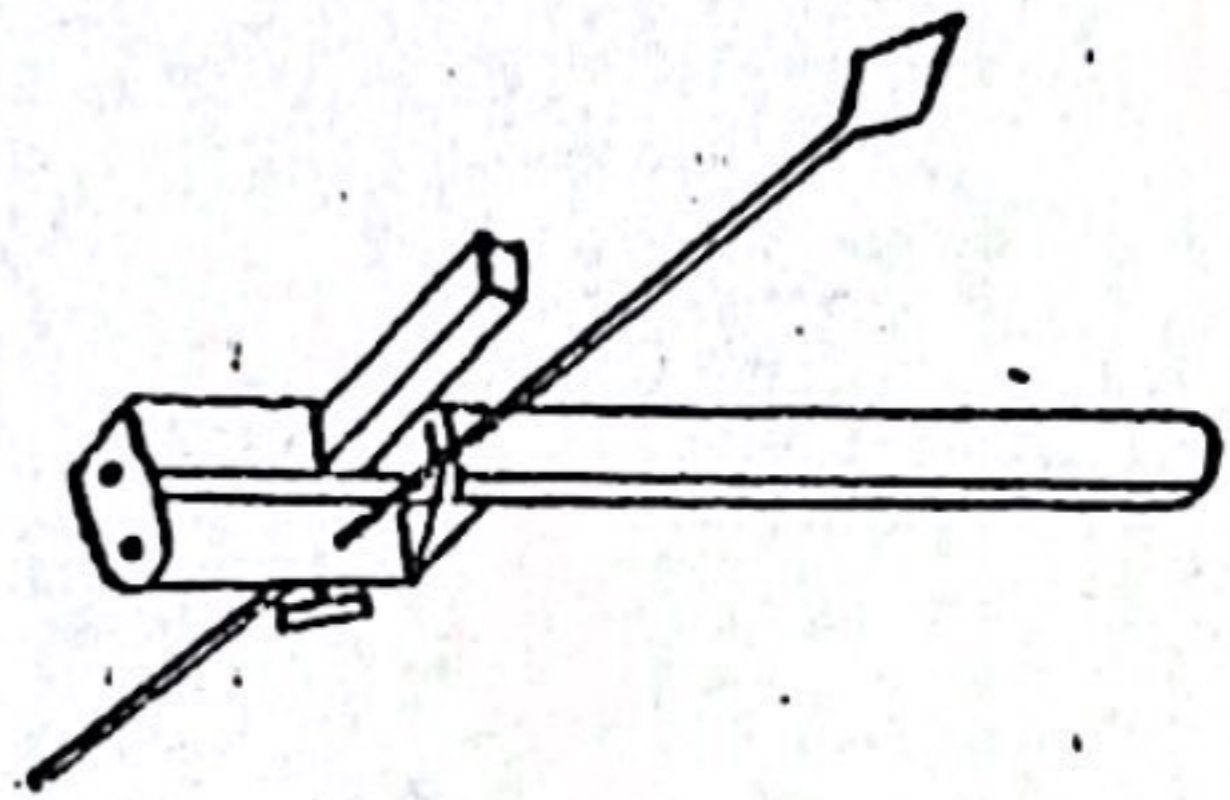

Fig. 39. Simple heart lever.

2. Simple Heart Lever

This lever consists of an aluminium rod fixed with an adjustable screw. The screw helps to change the length of the long and the short arm. The long arm has a writing point at the distal part. The short arm is connected with heart through a hook and thread.

The Frog's Heart

The structure and the function of the heart in the frog are altogether different from those of man and other mammals. However, the fundamental properties of the cardiac muscle are

common to all of them. The mammalian heart is very stringent in its requirements for oxygen, temperature and ions; while the frog's heart muscle is very sturdy. A primary study can therefore, be conveniently made on the frog's heart.

Unlike the four chambered mammalian heart, the frog's heart has only three chambers—two atria and one ventricle. The blood is collected in the sinus venosus whence it enters the right atrium. From the right atrium it enters the ventricle, where it gets partially mixed up with the arterial blood coming from the left atrium. As the ventricle contracts the blood enters the bulbous aorta. The bulb contains a spiral valve, which directs the venous bloods to the pulmonary arteries and the arterial blood to the body. The venous blood after getting aerated in the lungs is brought to the left atrium through the pulmonary veins. The left as well as right atrium pumps the blood in the ventricle.

General Dissection

The following steps should be followed :

- (1) The frog is pithed in the same manner as described in the nerve muscle physiology.
- (2) The frog is fixed in the dissection tray.
- (3) A small portion of the skin from the abdomen should be held in the forcep and a small cut given, which should be extended upto the jaw.
- (4) The Rectus muscles of both sides should be cut longitudinally, taking care of any damage to the heart or any major blood vessel.
- (5) The sternum is cut with a strong pair of scissors.
- (6) The pericardium is gently held in forceps and a small cut given.
The heart is exposed and ready to use for experiments.

Observations

Note and identify the following :

The single ventricle

The right and left atria.

The aortic bulb.

The atrioventricular groove.

The aortic and pulmonary trunks.

Now with two fingers of left hand gently invert the heart upwards and identify the following :

The superior vena cava

The inferior vena cava.

These two with other small veins join to form the Sinus venosus.

Note also a white transverse line, 'the crescent' where the sinus joins the atria. It is the site where the peripheral autonomic parasympathetic ganglia (Remark's ganglia) are situated

Introduction to Heart Experiments

Now concentrate on the working of the heart. It contracts quite rapidly. Measure the rate per minute. It is between 20 to 80 beats per minute. Try to find out the sequence or the direction of the contraction wave. It is not very easy, if the heart is beating more than 50 beats per minute. The contraction wave starts in the sinus venosus, spreads over the auricles, after which the ventricle contracts and finally the wave reaches the bulb. There is a slight pause after this and then a fresh wave starts.

Note that the heart does not possess any blood vessel.

Exposure of Vagus

The petrohyoid muscle should be exposed at the angle of the jaw. It arises from the skull base and is inserted into the hyoid bone. The petrohyoid muscle is cut at the most lateral position, exposing a shining white tendinous sheath which will be crossed by the vagus nerve. The vagus nerve is dissected properly till the heart. Preferably vagi of both sides should be dissected.

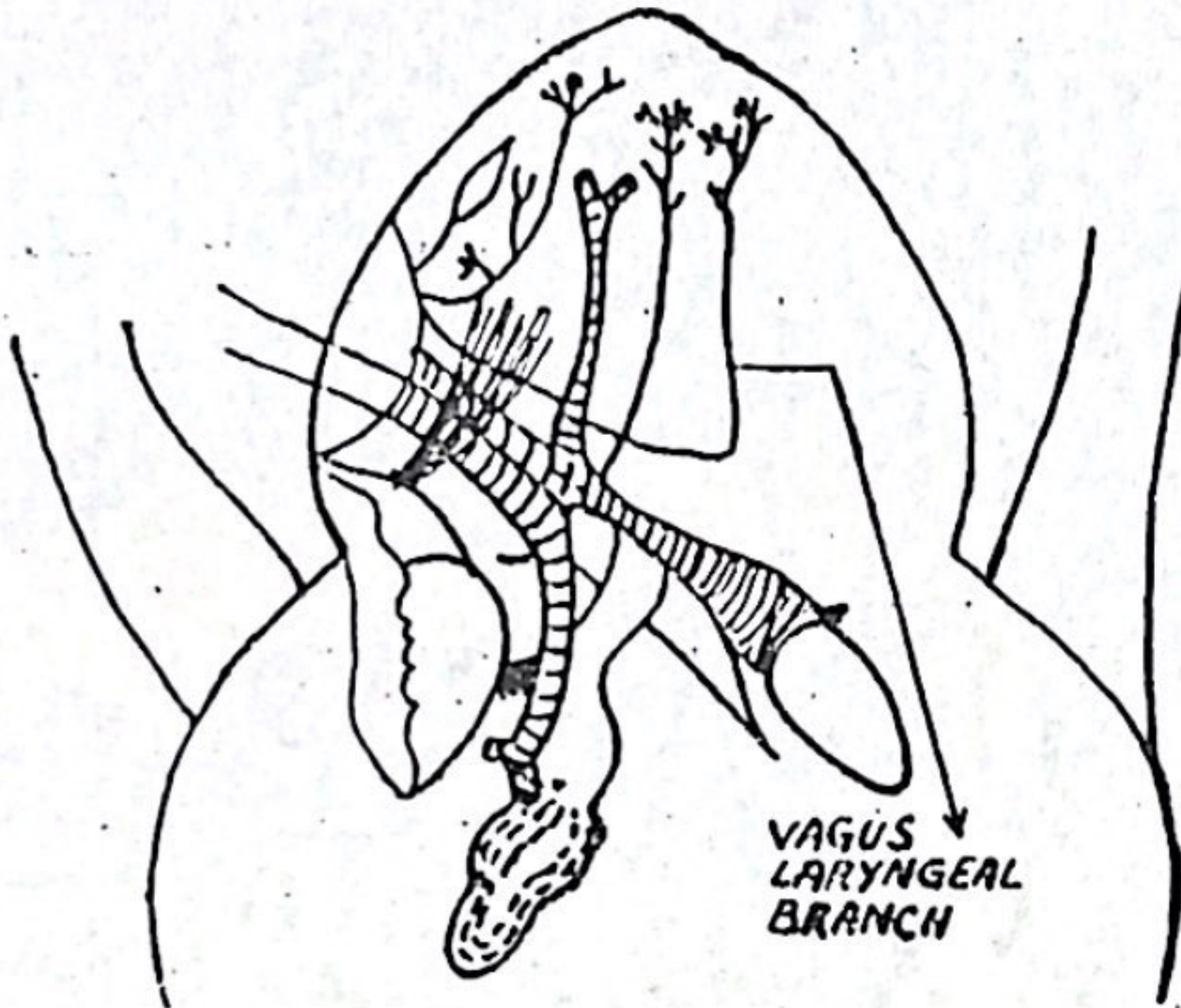

Fig. 40. Vagus nerve is exposed.

General Rules for Heart Experiments

- (1) Heart is a delicate structure, hence a gentle handling is required.
- (2) The hook should be carefully inserted into the ventricle, so as to not puncture the heart cavities which is likely to produce much bleeding. It should only pass through the musculature.
- (3) The hook should be introduced only when the experiment has to be started.
- (4) Since the vertical position of the heart is abnormal for it, after some recording the thread may be loosened to provide rest, and then reuse it.

- (5) Ringer's solution should be used very frequently, so as not to allow the heart to become dry.
- (6) The writing point should be horizontal and should gently touch the drum. If tightly pressed it will be difficult for the heart to pull down the lever.

Cardiogram

Cardiogram is the recording of the mechanical activity of the heart. The Starling's lever is attached to the apex of the heart and the movements of the lever are recorded on the moving drum.

The cardiac impulse originates in the sinus and spreads over the arteries and the ventricle. Since there is no specialized tissue for conduction of the impulse the conduction of the impulse is along the cardiac muscle fibre.

The speed of the drum should be sufficiently fast so as to study the events properly as these spread out.

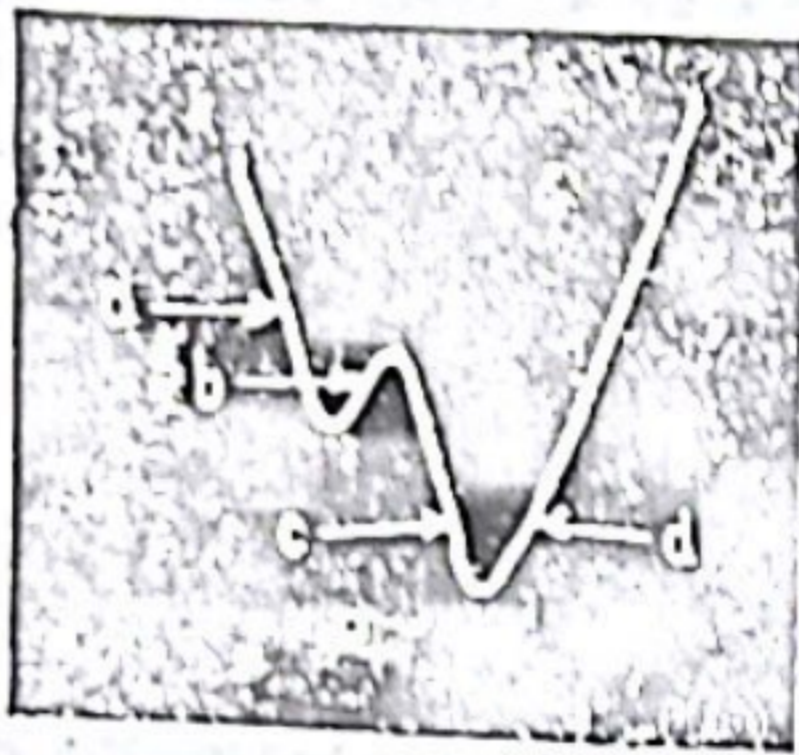

- a : auricular systole
- b : auricular diastole
- c : ventricular systole
- d : ventricular diastole

Fig. 41. Normal cardiac cycle.

Apparatus

Kymograph, studying heart, lever, frog's board, electromagnetic time signal maker, Ringer's solution.

Drum Speed : 1.2 mm.

Procedure

- Fix the Starling lever on a stand with a frog board. Fix it at such a level that when horizontal, the writing point writes at a desired level on the paper.
- Tie the bent pin to one end of the piece of thread.
- Place the dissected frog on the board attached to the stand, with the head near the rod of the stand, so that the heart comes directly below the lever.

Introduction to Heart Experiments

- Hold the ventricle of the frog in between the fingers and the thumb of the left hand, firmly but gently, and pass the bent pin through the ventricular musculature. See that the pin does not pass through the cavity of the ventricle.
- Alternatively, instead of fixing the pin, you can tie the thread directly to the muscle. At one end of the thread put a loose knot. Take a fine forceps and slip the loop of the knot over it. Catch a bit of the ventricular musculature and slide down the loop over it. Tie the knot and remove the forceps.
- Tie the other end of the thread to the lever (or else fix it with plasticine), in such a way that the lever remains just above the horizontal level during the diastole of the heart.
The lever will now move with each systole and diastole of the heart.
- Put the drum in slow gear and pulleys as 4 : 1.
- Adjust the stand to write on the paper and obtain a record of about 10 cm length.
- Also obtain records with slow gear and pulley connections as 4 : 2, 1 : 1, 2 : 1, and 1 : 4 and fast gear 4 : 1

Observations :

- (1) The downstroke indicates the contraction of the heart muscle, while the upstroke the relaxation.
- (2) In the record with slow gear and 1 : 4 pulley connections the following phases are seen.

A small atrial contraction is immediately followed by a large ventricular contraction. This is followed by a small pause. Many times a very small sinus contraction is found to precede the atrial one and a bulbar one following the ventricular contraction.

Discussion

The cardiac impulse (wave of depolarization) passes quickly over the atria and on to the ventricle from muscle cell to muscle cell. The slight pause between the atrial and ventricular contractions is due to a partial block to the passage of the excitatory wave. There is no definite fibrous ring between the atria and the ventricle, though there is muscular continuity. The muscle fibres at this junction run circularly around the heart and not directly from the atria to the ventricle. This may account for the delay between the atrial and ventricular contractions. In a normal cardiac cycle the sinus possesses a higher frequency of rhythm than the other chambers and therefore determines the rate of the heart—thus acting as the pacemaker.

Experiment to Study Properties of heart muscle

Object. To study the following properties of heart :

- (A) Effect of stannius ligature
- (B) 'All or None' law in cardiac muscle
- (C) Staircase phenomenon in cardiac muscle
- (D) Refractory period of cardiac muscle,

PART A

Effect of Stannius Ligature

Apparatus. Recording drum, Starlings heart lever, time marker, glass seekers, thread.

Circuit. Since the electrical stimulus is not to be used, hence there is no circuit.

Speed of drum. Slow,

Procedure

- (1) The frog is dissected and the heart is exposed.

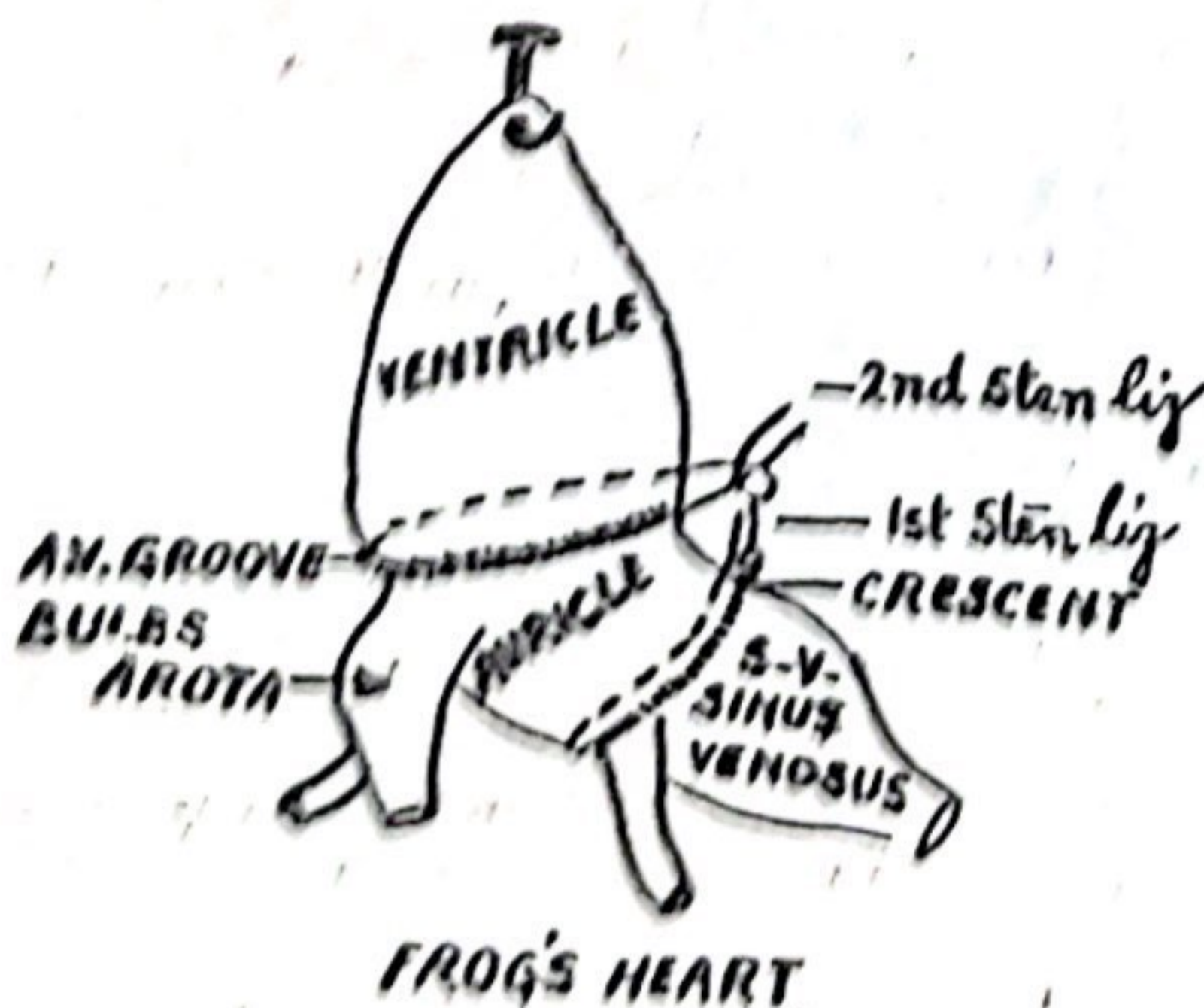

Fig. 42. Site of the two stannius ligatures

Experiment to Study Properties of Heart Muscle

- (2) A piece of thread is passed between the sinus-venosus and the auricle. This can be conveniently done while lifting the ventricle with one hand and using a fine forceps for passing the thread between the heart and Bulbous arteriosis. The two ends are let loose to be tied, over the sinoauricular junction. This is ligature I.

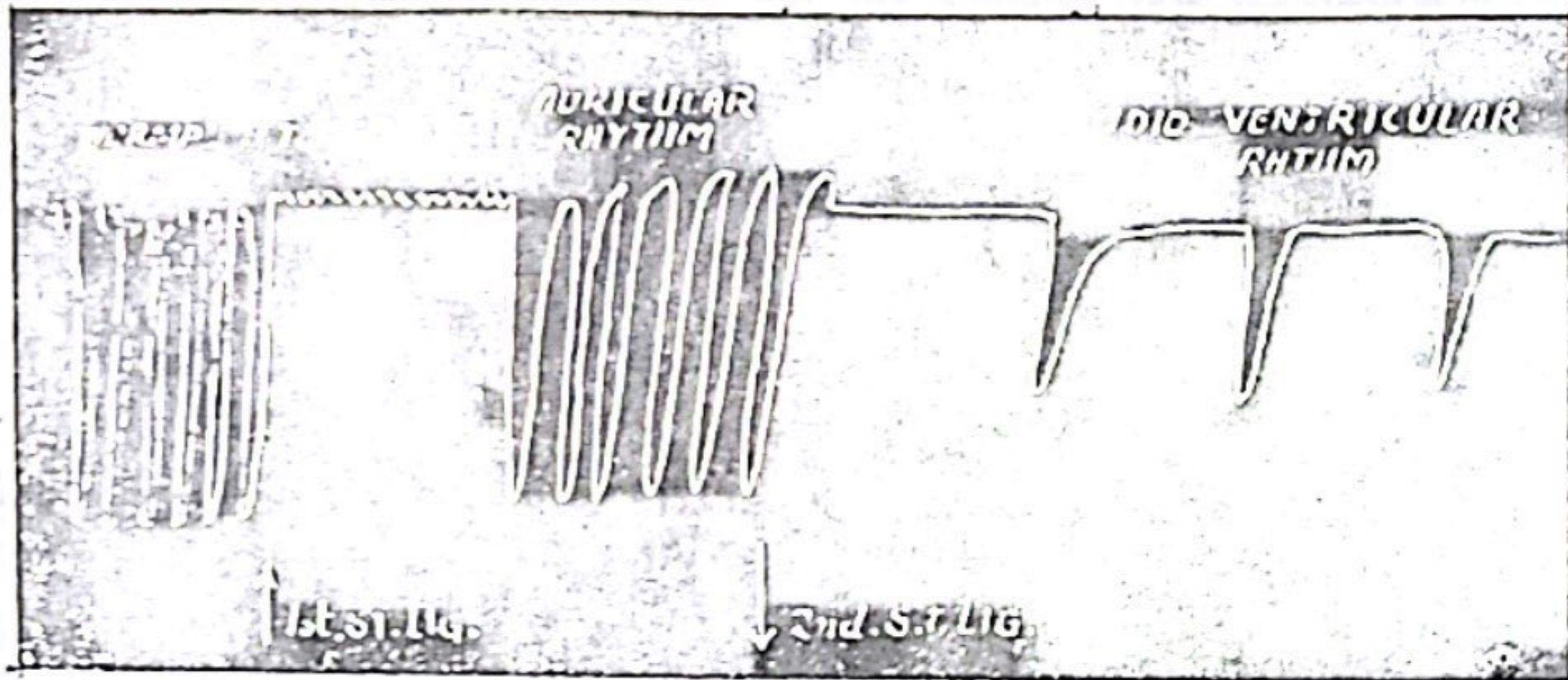

Fig. 43. Stannius ligatures 1st and 2nd.

- (3) The recording lever is adjusted and the ventricle hooked to the lever.
- (4) The normal heart beats are recorded on a slowly moving drum for few beats.
- (5) The drum is stopped and the ligature I is tied just over the sino-auricular junction.
- (6) The drum is stopped and contraction recorded.
- (7) The drum is stopped and one should wait for 10-15 minutes till such time that the auricles and ventricles start contracting.
- (8) Again the drum is started and the recording is taken.
- (9) Drum is stopped. A loop of thread is passed between the auricle and ventricle. This is 2nd ligature. This is tied. Drum is restarted and immediate effect is recorded.
- (10) Drum is again stopped. Wait for some time till the ventricle starts contracting. And the contractions are recorded.
- (11) The time tracing is recorded. The rate of three rhythms—Sinus-rhythm, auricular rhythm and Idioventricular rhythm is calculated.

Relevant Questions

- (1) What is the principle of this experiment?

The application of the ligatures is an attempt to block the transmission of the cardiac impulse from the sinus to the auricle in the first case (Ligature I) and from the

auricle to the ventricle in the second case (Ligature II) and demonstration of the sinus-rhythm, auricular rhythm and idio-ventricular rhythm.

(2) What are the precautions relevant to the experiment?

(i) The Ringer's solution should be poured frequently over the heart.

(ii) The ligatures should be carefully and properly tied.

(3) What are the observations in the experiment?

(i) After the application of Ligature I the heart stops except sinus-venosus. This is recorded by a horizontal wavy line.

(ii) After some time the auricle and the ventricle start contracting. This is the auricular rhythm.

(iii) After the application of Ligature II the ventricle stops where as the auricles continue to contract.

(iv) After some time the ventricle starts contracting. This is known as the idio-ventricular rhythm.

(4) What is a pace maker?

The part of the heart which first initiates the electrical impulse and the impulse is transmitted to other parts followed by contraction is called the pace maker of the heart.

(5) What is the pace maker in case of frog's heart?

Sinus-venosus is the pace-maker since it initiates the contractions.

(6) What is the pace-maker in man's heart?

It is the sino-auricular or Sino-atrial node which is at the junction of Superior Venacava and right atrium and extends along sulcus terminalis for 2 cms, being 2 mm. wide itself.

(7) What is the difference of rates of Sinus rhythm, auricular rhythm and indio-ventricular rhythm? Explain.

The rates of Sinus rhythm, auricular rhythm and indio-ventricular rhythm are in the descending order. Because the impulse is generated in the sinus-venosus which beats to the faster extent, and the ventricle is the last part to receive the impulse hence the rate of idio-ventricular is least.

The explains the sinus-venosus is the pace-maker.

PART B & C

All or None Law and Staircase Phenomenon

Apparatus, Same as used in the experiment of Stannius ligatures.

Electrical circuit. The drum is excluded from the primary circuit, instead an Electro-magnetic signal marker is introduced.

Experiment to Study Properties of Heart Muscle

Speed of drum. Stationary.

Stimulus. Variable.

Procedure

- (1) This experiment should be considered a continuation of the application of stannius ligatures I and II.
Hence, when the ventricle has stopped after the application of both the ligatures, this experiment should be conducted.
- (2) The primary and secondary coils are kept at the farthest distance gradually being brought close and single break shocks are given. Time gap between first and the second shock should not be less than half a minute.
- (3) The response of each shock is labelled.
- (4) The drum is manually moved away from the previous record.
- (5) Several stimuli are given in quick succession and the response of the heart muscle recorded. At least 5-6 contractions should be recorded.
- (6) All the tracings are labelled and the height of the contraction compared.

Relevant Questions

- (1) What are the observations of the experiment?
After having applied the I and II stannius ligatures and single 'break' shocks being given after a minimum gap 30 seconds between two stimuli, it is observed that either the muscle does not contract or if it does, it contracts to its maximum efficiency irrespective of the strength of the stimulus.
This is all or none law, when the stimulus are given in quick succession it is observed that there is an increase in the height of the contraction with successive stimuli. This is the stair case phenomenon.
- (2) Why is the experiment conducted in a quiet heart?
When the heart has stopped, there is no interference of the impulses of the heart itself henceforth a study of the properties of the heart muscle can be conducted properly.
- (3) What are the causes of the stair case phenomenon?
Stair case phenomenon of the heart muscle is due to the beneficial effects of the previous contraction. The muscle does not even recover fully and a new stimulus arrives, henceforth an accumulation of the products of contraction and rise of the temperature takes place, leading to favourable condition for a better response.
- (4) Is there any contradiction to 'All or None law' and stair case phenomenon?
The 'All or None' law and stair case phenomena do not contradict because while conducting the experiment of 'all or none law' a time gap of 30 seconds is always

kept between one stimulus and the other to make sure that there is complete recovery from the first stimulus. Whereas in the experiment of stair case phenomenon successive stimuli are given without giving the muscle a chance of recovery, henceforth we obtain beneficial effects.

PART D

Refractory Period and Extrasystole

Apparatus. The primary circuit apparatus consists of primary coils of induction coil, signal marker, primary key and the mains. The secondary circuit apparatus consists of secondary coils of the induction coil, short circuiting key, starlings heart lever, heart electrodes (a simple wire from which a coating of insulating material is scrapped off at the ends), heart preparation—with instruments of dissection. Recording drum, thread, plasticine etc.

Circuit. Drum is excluded from the primary circuit and signal marker is included in it. Rest the circuit is same as used in simple muscle curve.

Speed of drum. Moderately slow.

Electrical stimulus. Minimal.

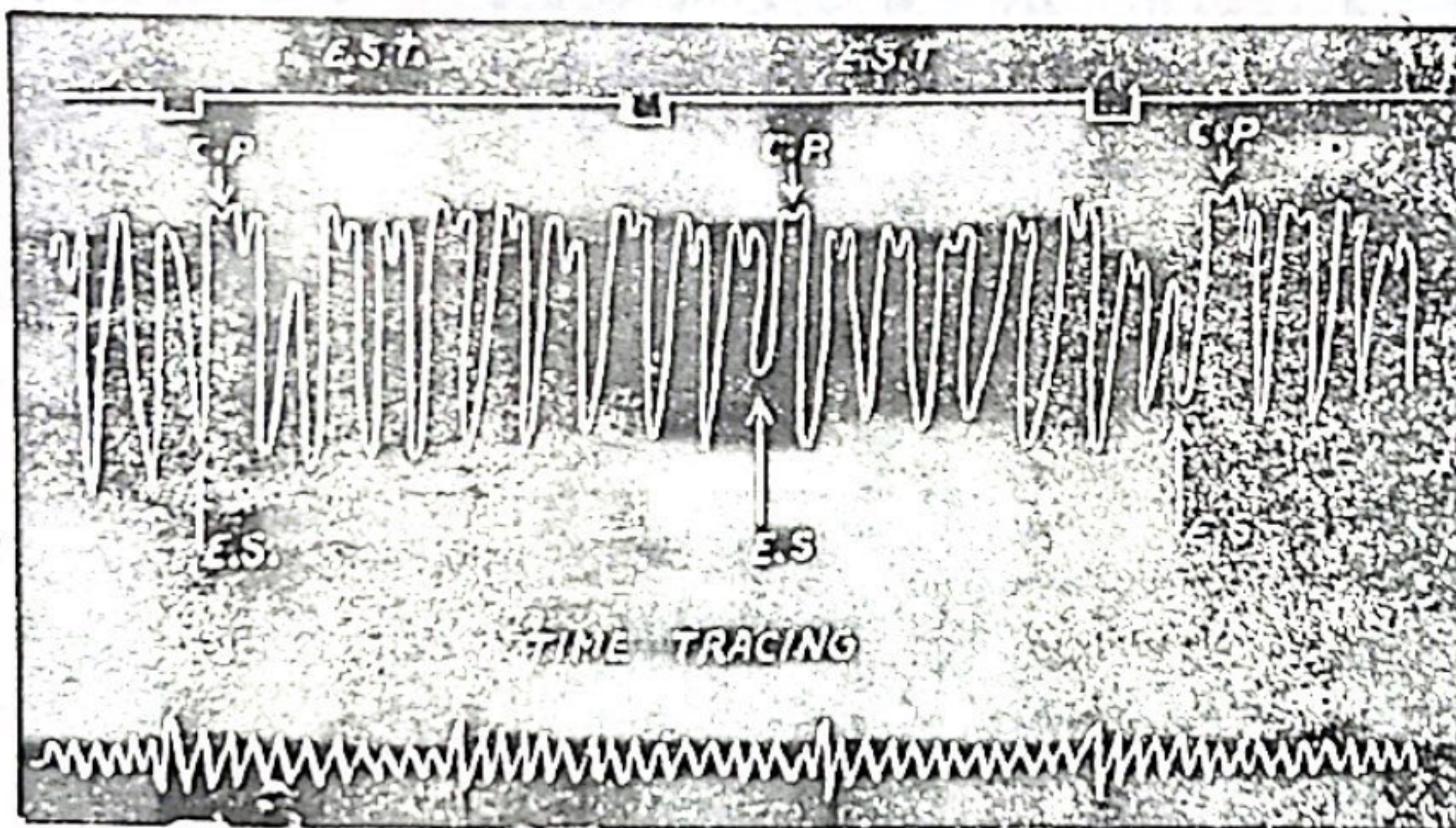

E.S. indicates extrasystole.

C.P. compensatory pause

Fig. 44

Procedure

- (1) The frog is dissected.
- (2) The heart is exposed and hooked with the starlings heart lever. Electrodes are applied on the ventricle surface.
- (3) The distance between primary and secondary coils is so adjusted that a minimal stimulus is obtained.

40

Experiment to Study Properties of Heart Muscle

- (4) A few normal beats are recorded.
- (5) A 'Break' shock is applied by opening the short circuiting key and thereafter the primary key.
- (6) Two, three times it is repeated till the stimulus falls in the relaxation phase and an extrasystole is observed followed by a compensatory pause.
- (7) The electromagnetic signal gives us an idea to the stage when the stimulus was given.
- (8) The graph is labelled properly.
- (9) A time tracing is taken.

Relevant Questions

- (1) What is refractory period ?
The period of inexcitability is called refractory period. During this period the heart cannot be excited, however strong a stimulus may be in duration and in strength.
- (2) What is the cause of the refractory period ?
In normal muscle fibres negative ions are more than the positive ions in the inner side of the membrane. The cardiac impulse results in a change of this ionic state. Hence during the time any stimulus how so ever strong cannot be effective till the ionic state is re-established. During systole there are more of positive ions than negative ions in membrane hence muscle is refractory to any stimulus.
- (3) How much is the refractory period of human heart ? What is the advantage of long refractory period ?
0.3 seconds of time is taken as the average refractory period of human heart. Long refractory period helps the preservation of normal cardiac rhythm and the heart gets rest for further contractions with good vigour.
- (4) What is an extra systole and how it is produced ?
Extra systole is a premature contraction obtained by stimulating the heart during the relaxation phase *i.e.* after its refractory period is over.
- (5) What is compensatory pause ?
The pause obtained after the extra systole is of a greater duration than after normal systole because the extra systole is a premature contraction. This pause is called compensatory pause.
- (6) What is the cause of a more forceful beat followed compensatory pause ?
Since the ventricle has a greater diastolic stretch after the compensatory pause hence the beat is more powerful.
- (7) What is the duration of extrasystolic cycle ?
The duration of the extra systolic cycle and the returning cycle is equal to two normal cycles.

Effect of Temperature and Drugs on heart muscle

Object. To record the normal heart beat of frog. To demonstrate the effect of temperature and drugs on heart beat.

Apparatus. Recording drum, Starling's heart lever, time marker, glass sealer, plasticine, and drugs e.g. adrenaline and acetyl choline.

Circuit. Since the electrical stimulus is not to be used, hence there is no circuit.

Speed of drum. Medium slow.

Procedure

- (1) The frog is dissected and heart exposed as described in detail in the introductory chapter.
- (2) The frog is transferred to the myograph board. The tip of ventricle is hooked to the lever.
- (3) The writing point of the Starling's heart lever is brought in close and gentle contact with the smoked drum.

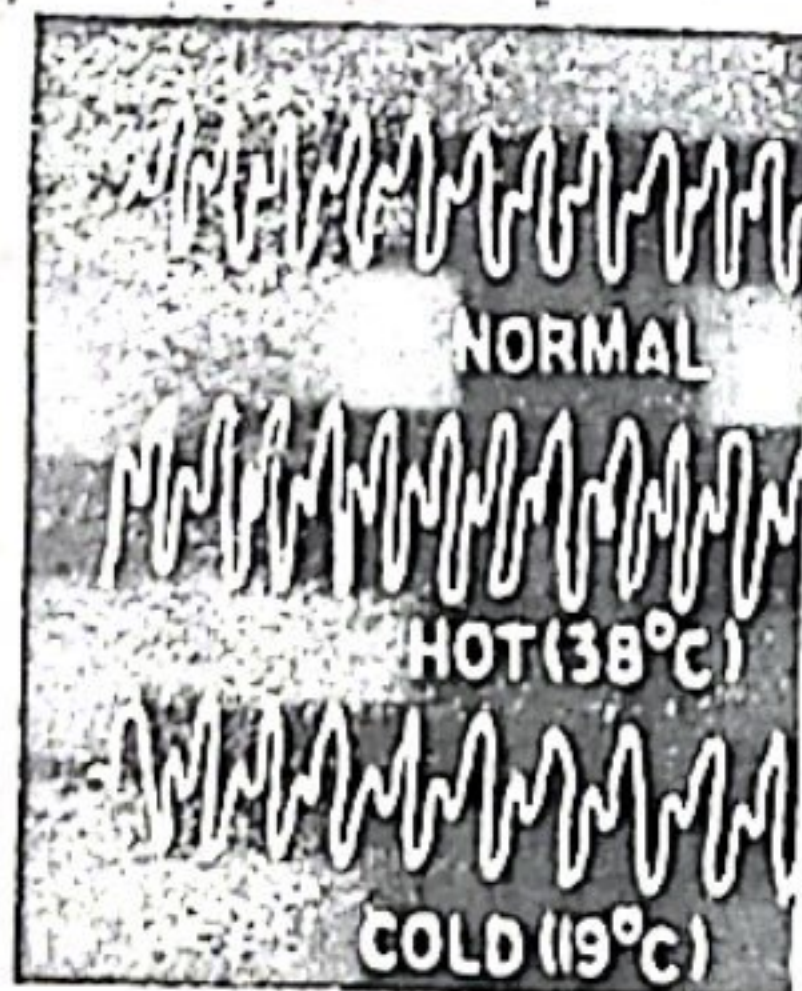

Fig. 45. Effect of temperature

Effect of Temperature and Drugs on Heart Muscle

- (4) The normal beat of the heart is recorded. The events of the cardiac cycle are marked.
- (5) The drum is stopped. Hot Ringer's solution (temp. range above 30°C but below 40°C) is poured continuously for a few minutes. The drum is started and the beating of heart recorded.
- (6) Heart is washed with Ringer's solution at room temperature for a short while. The normal heart beat is again recorded.
- (7) The heart is washed now with Ringer's solution at temperature below 25°C. The washing is done for few minutes. And the heart beat is recorded.
- (8) The drum is stopped. Heart is thoroughly washed with Ringer's solution at room temperature for few minutes. Again the normal heart beat is recorded.
- (9) Drum is stopped. A few drops of Adrenaline solution is poured on the frog's heart. The drum is allowed to rotate and the effect is recorded.
- (10) The drum is stopped. It is washed with Ringer's solution at room temperature. Washing is continued for a few minutes and normal heart beat is again recorded.

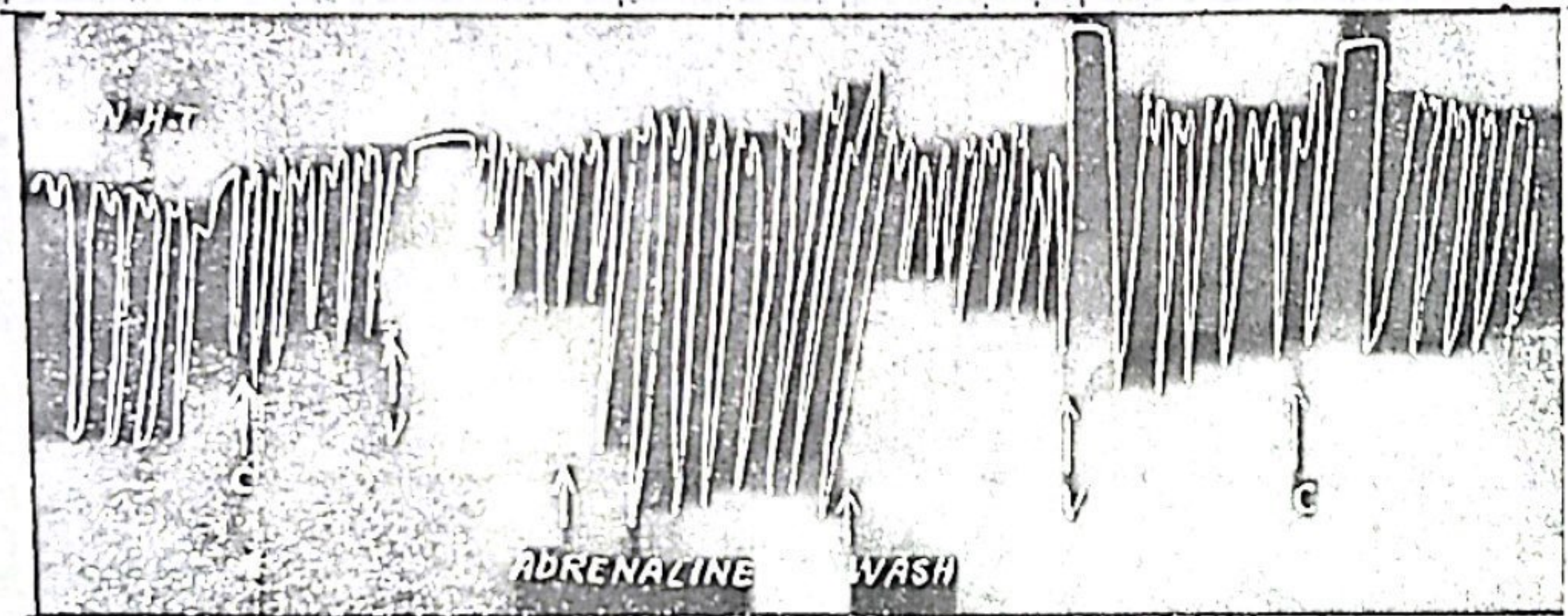

Fig. 46. Effect of Adrenaline on Frog's heart.

- (11) The drum is stopped. A few drops of Acetylcholine are poured on the frog's heart. The drum is rotated and the effect of acetylcholine is recorded on the drum.
- (12) The heart is rewashed with Ringer's solution and Pilocarpine is poured. The impact is recorded.
- (13) Again the heart is rewashed and Nicotine is poured and the effect recorded.
- (14) After thorough washing Atropine is poured and the effect is recorded.
- (15) Time tracing of known frequency is recorded.

(16) All the tracings are labelled and fixed.

One has to keep in mind that before and after using any drug the heart has to be washed with—Ringer's thoroughly till the normal heart tracings are obtained.

Relevant Questions

(1) Describe the normal heart beating of the frog's heart.

The downward contractions are systoles and upward contraction are diastoles. In the figure the following are the codes.

(2) What are the observations in regard to temperature effect on the heart beat ?

The rate of heart beat is decreased on cooling and is increased with the rise of temperature. This is decreased with the help of counting the heart beats in relation to the time (calculated from time tracing).

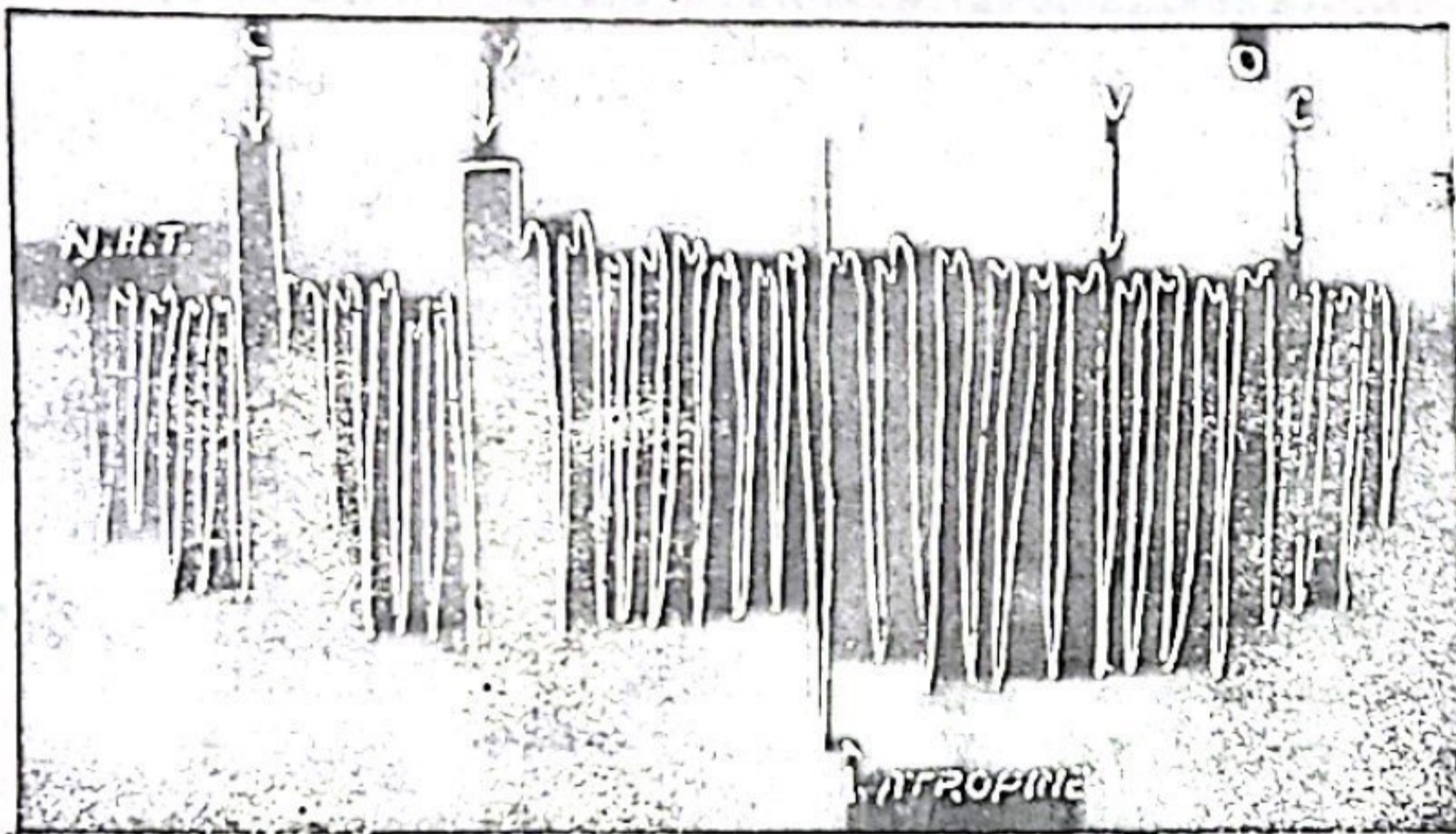

Fig. 47. Effect of atropine.

(3) What is the site of action of temperature changes in heart ?

In the frog's heart the sinus-venous is the site of action of temperature changes. Sinus-venous is the 'Pace maker' of the frog's heart because it initiates the heart beat. It has a rich nerve supply and capillary network.

(4) What is the effect of temperature above 45°C on heart ?

The heart muscle is damaged at a temperature above 45°C. The heart becomes irregular and the heart stops.

(5) What is the use of frequent washes with normal Ringer's solution at room temperature after every observation ?

Effect of Temperature and Drugs on Heart Muscle

Once the effect of a drug or temperature has been recorded, the heart should be thoroughly washed with Ringer's solution at room temperature so as to completely remove the previous effect and avoid fallacy of observation for future effects.

(6) What is the effect of Adrenaline on frog's heart ?

Adrenaline increases the rate of heart beat and the force of contraction.

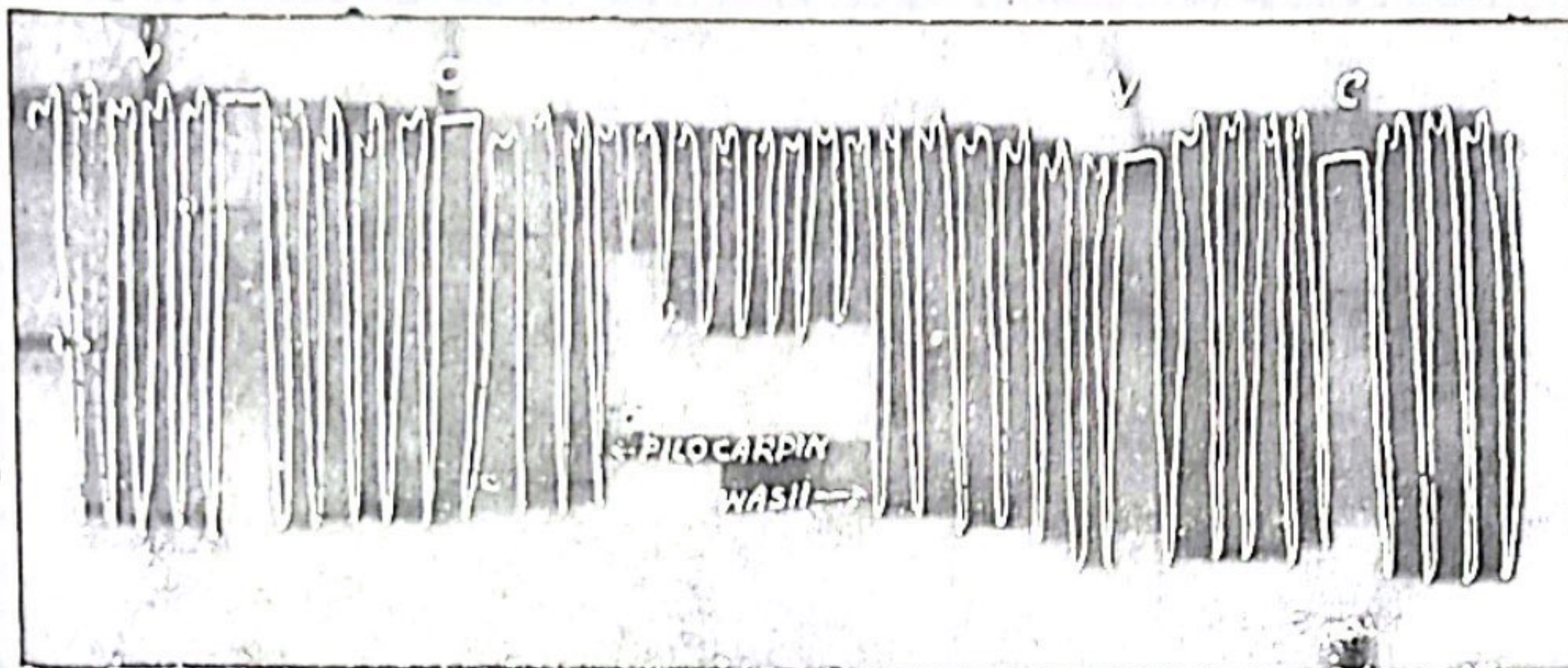

Fig. 45. Graph showing effect of Pilocarpine on Frog's heart

(7) What are adrenergic fibres ?

Sympathetic post ganglionic fibres where adrenaline and adrenaline like substance is liberated peripherally are called adrenergic fibres.

(8) What are the sites of biosynthesis of adrenaline in human body ?

Peripheral and central adrenergic neurons and in the chromaffin cells of the adrenal medulla.

(9) What is adrenaline chemically ?

It is a secondary alcohol formed by methylation of non-adrenaline.

(10) What is the effect of adrenaline on blood pressure ?

The systolic blood pressure is raised where as diastolic is unaffected or slightly lowered. By this it increases the pulse pressure, with non-adrenaline there is also rise of B.P. but the pulse pressure is maintained.

(11) What is the pulse pressure ?

The difference between the systolic and diastolic pressure is called as pulse pressure.

(12) What is the effect of acetylcholine on frog's heart ?

The heart rate is decreased and the force of contraction is also decreased.

(13) What are cholinergic fibres ?

All fibres which liberate acetyl choline at the nerve endings are termed as cholinergic fibres. These include (i) all pre-ganglionic fibres—parasympathetic and sympathetic (ii) post ganglionic parasympathetic fibres.

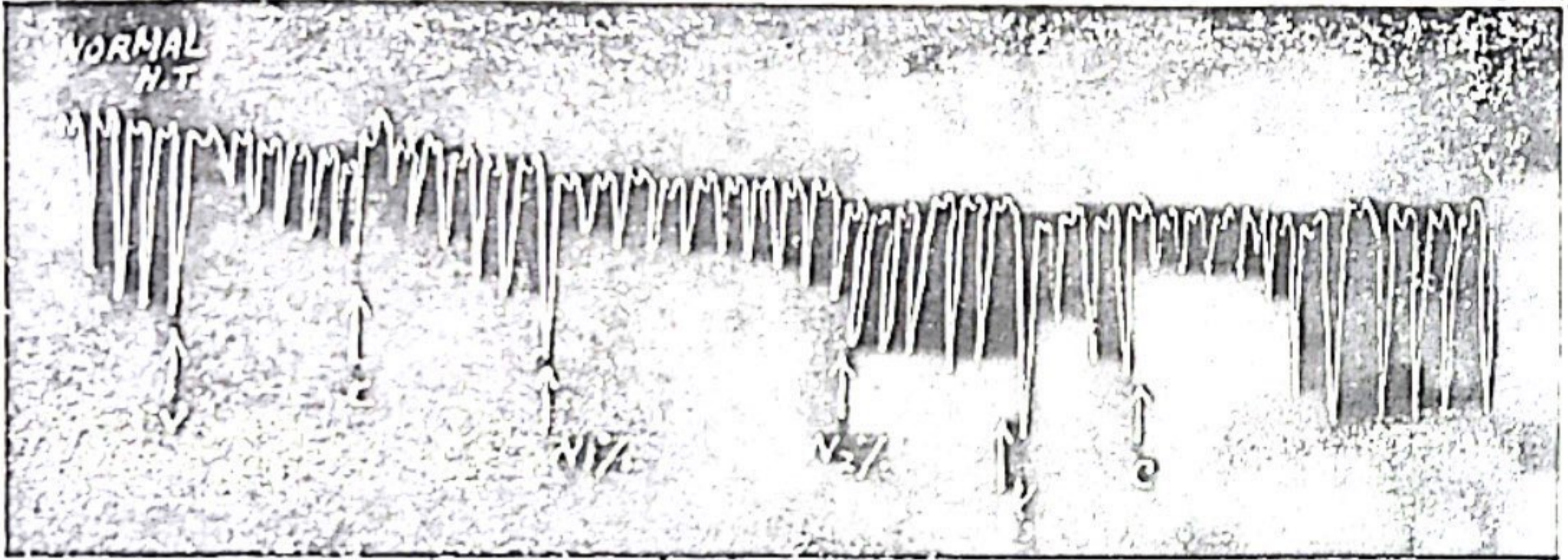

Fig. 49. Graph showing effect of nicotine on frog's heart.

46

EFFECT OF TEMPERATURE AND PACE-MAKER

Experiment Two

Pace-Maker : The part of the heart which controls and lead the heart rate.

The dependence of the heart rhythm on the beat of the sinus may be shown in the following way :

- 1) Have ready warm and cold Ringer solutions, a thermometer, a pipette and a small glass rod with a flat end and some ice. Prepare a frog's heart *in situ* as before and record a few normal contractions on a slow drum.

Stop the drum and gently pour warm Ringer solution at about 35°C on the whole heart until it accelerates and quickly record the beats. Stop the drum until the heart recovers its normal rate. Repeat with Ringer solution at 5°C. Take time record and count the rate of the heart at the different temperatures minute.

- 2) Record the normal beat and then warm the flat end of the rod in hot ringer solution (or on the flame) and approach it very near to the sinus, the heart rate accelerates. Recover the heart and repeat with a very cold rod, the rate slows down. In the same way, warm and cool the auricles and again the ventricle.

When the ventricle is warmed the beats become somewhat larger but rhythm (= rate) is unchanged.

On warming the sinus, the rhythm of the whole heart is quickened. This means that the sinus venosus is the pace-maker of the heart.

THE RHYTHMICITY OF THE FROG'S HEART

a) The Whole Heart:

The heart of the frog does not stop beating when removed from the body which shows that the cause of the heart beat lies within the heart muscle itself, i.e. myogenic.

Cut widely round the sinus and veins, cut through the aorta and place the excised heart in a watch glass containing Ringer solution at room temperature. Notice that it continues beating and that the sequence of contractions of the different parts is unaltered, the sinus being the first, the other parts following it. Count the heart beat before and after excision (unit time). If the heart is in good condition there may be a slight acceleration.

b) The Isolate Chambers :(Myogenic Rhythmicity)

Make an incision through the sino-auricular junction so as to separate the sinus from the heart. Count the rate of the beat of the sinus and compare it with the rest of the heart. Both continue beating, the rhythm of the sinus being unaltered, but the auricle taking a slower rhythm. Cut the ventricle away from the auricles by an incision just above the auriculo-ventricular groove. Note that the auricles continue beating without any alteration in the rate, provided they are not injured too much. The ventricle, after a few beats due to the excitation of the incision, stops beating and only after a considerable time may begin again to contract very slowly, at its idioventricular rhythm.

There is thus a descending scale of automatic power in the different parts of the frog's heart from the sinus, where rhythmicity is highest, than the ventricle, where the rhythmicity is lowest. Each isolated chamber of the heart, beat at its own rhythm.

EXCITABILITY AND CONTRACTILITY

1) All or None Law :

Have ready a battery, a key, an induction coil, and a pair of electrode see Fig. 15. Use a stannised heart (1st Stannius ligature) and adjust the electrodes to touch the quiescent ventricle lightly. Arrange the connections to stimulate with single induction shocks. Record the contractions on a stationary drum, turning the drum a few millimeters after each contraction. Find a break shock which produces a contraction of the ventricle. Slightly diminish the strength of the break shock by shifting the secondary coil further away from the primary coil about 1.0 cm. each time. Wait 15 to 20 seconds after the 1st contraction and apply to the heart the weaker shock and record the contraction again. Continue to decrease the strength of the stimuli, until the heart fails to respond.

Note that there is no relation between the strength of the stimulus and the height of the contraction. The application of different stimuli produces contractions of the same height. This means that the heart muscle either respond maximally or not at all.

2) Summation of Subminimal Stimuli :

On the previous preparation find the subminimal stimulus that just fails to produce a contraction. Repeat this quickly at intervals of about 1 second after the repetition of the stimulus ten to twenty times, the heart responds with a maximal contraction. This means that even subminimal stimuli cause slight changes in the cardiac muscle which when added together raise the excitability of the muscle to such a degree that it responds readily. The effect is known as temporal summation of subminimal stimuli.

3) Stair-case Phenomenon :

Stimulate the stunned heart with an effective weak break induction shock and record the contraction on a very slow drum. Repeat the same stimulus at very short intervals of about 3 seconds. Note that the 1st few contractions form an increasing series each one being greater than the one before. This effect (which is also obtained in skeletal muscle) is known as the stair-case phenomenon and is due to beneficial effect of one contraction on the succeeding one. Note that this phenomenon is not contradictory to the all or none law where the stimuli of varying strength, are applied at sufficiently long intervals. Here the same strength of stimulus has an improving effect when it is repeated before the recovery process of the previous contraction is quite complete and so condition varies, e.g. accumulation of metabolites, pH, viscosity, etc.

4) The Rhythmic Response to a Continuous Stimulus :

Use a strong galvanic current and leave it passing through the heart. Record results on a slowly moving drum. The heart responds to the make of the current with a single contraction and after a pause it beats rhythmically.

Compare with skeletal muscle.

5) Refractory Period, Extra-systole and Compensatory Pause :

One of the fundamental properties of the cardiac muscle is that it is inexcitable to a stimulus applied during its systolic period and for a very short time in very early diastole. This is called the *absolute refractory period*.

After this period a contraction produced by an artificial stimulus is called an extra-systole and is followed by a pause much longer than the intervals between the normal contractions. This *compensatory pause* is longer the nearer the stimulus applied after the absolute refractory period it is due to the fact that the following impulse from the sinus arrives at the ventricle during the refractory period of the extra-systole this impulse produces no effect. The ventricle then remains non-contractile until the next normal excitation wave arrives from the sinus.

THE ABSOLUTE AND RELATIVE REFRACTORY PERIODS :

- Make ready the examination of frogs heart *in situ*. Adjust the electrodes to stimulate the heart with single induction shocks using a key in the primary circuit (Fig. 15). Find the minimal effective stimulus, carefully watch the heart lever as it records up and down. Stimulate the ventricle by individual shocks, each shock at one of the following phases :

- a) At the beginning of contraction.
- b) At the height of the contraction.
- c) During the beginning of relaxation.
- d) At the end of relaxation.

Stimulation during contraction :

Observe that there are no response to the (a) and (b) stimuli.

When the excitability of the heart muscle is tested during the contraction and early diastole it will be found that no stimulus, however strong, can evoke a response. This is the absolute refractory period.

Stimulation during relaxation :

Following this a short period which coincides with remaining part of the relaxation period of the heart, during which the heart muscles gradually recovers its normal excitability and therefore is found to respond only to a stronger stimulus, i.e. above threshold. The threshold stimulus evokes no response. This is the relative refractory period.

The absolute and relative refractory periods make up the total refractory period

Since the heart is absolutely inexcitable during its systole and early part of diastole, the cardiac muscle can never show tetanus or even summation of contractions.

Moreover, the long duration of this absolute refractory state, ensures that complete recovery of the heart occurs, and therefore, it never becomes fatigued. This explains the ability of the heart to beat rhythmically throughout life without any signs of fatigue which occurs in other muscles under similar circumstances.

THE PERFUSION OF THE FROG'S HEART

Experiment Five

The frog's heart when cut out of the body continues to beat for a certain time and then gradually dies. The mammalian heart dies under those conditions much more quickly (one or two minutes). In both cases the cause of death is the lack of O_2 and lack of the appropriate saline medium. If the heart is perfused with a fluid which is isotonic with the blood and an adequate supply of O_2 is maintained, the heart will continue to beat for a much longer time.

It was shown by Ringer that the solution must not only be isotonic with the blood but must contain Na, Ca and K in definite proportions. The most appropriate solution for the survival of the frog's heart is as follows :

0.65 gm. NaCl, 0.015 KCl, 0.012 $CaCl_2$, 0.01 $NaHCO_3$,
0.001 NaH_2PO_4 , 100 c.c. distilled water.

It is generally perfused at room temperature and does not require the continual bubbling of O_2 , as there is always enough O_2 in solution for the requirement of the frog's heart. For pharmacological investigations drugs are added to the Ringer solution and their actions are studied.

Experiment :

Prepare the apparatus and fill the reservoir with fresh Ringer solution. Fill the siphon tube leading to the perfusing cannula. Place a beaker below the cannula to receive the outflow from the heart.

Expose the heart of a large frog as usual and pass a fine small hook through the tip of the ventricle taking care not to pierce its cavity. Place the heart on its anterior surface. The weight of the hook will keep it in position and the sinus venosus

is thus exposed. Very gently remove the pericardium from the sinus and from the 2 hepatic veins that join it and free the sinus. Pass a thin thread under the sinus and make a loose knot. With a fine forceps pick up the wall of the sinus and keep holding it until you introduce the cannula. With a sharp scissors make a small cut in the sinus near the junction of the hepatic veins. As soon as the blood comes out, pull gently the sinus wall to stop bleeding and introduce the cannula forwards into the sinus. Tie the ligature well on the cannula. Gently raise the cannula and cut the heart away from its connection taking care not to injure it. Clamp the cannula in position and quickly perfuse. The fluid circulates from the sinus to the right auricle, to the ventricle and then drops out from the cut aorta. Keep the height of the perfusing fluid in the cannula constant by adjusting the inflow to be equal to the outflow. Attach the hook to the recording lever and record the heart beat on a very slow drum.

Effect of Drugs and Salts

1) Adrenaline

Place in the cannula one drop of 1/10,000 adrenaline and mark on the graph the exact point of its addition. Note the acceleration and augmentation of the heart beat. Perfuse until the heart recovers.

2) Pilocarpine

Place in the cannula few drops of pilocarpine, 1 in 100. The contractions become smaller, the rate slows down and heart may stop.

3) Effect of the Reaction of the Perfusion Fluid.

Have ready the following solution :

a) **Acidic** : Add diluted HCl or lactic acid.

b) **Alkaline** : Add N/10 NaOH solution drop to Ringer solution until just alkaline.

Now perfuse with normal Ringer followed by acid solution, note that the beats become weaker and weaker until the heart stops in a relaxed state.

Record the heart with normal Ringer and then perfuse with alkaline solution, note that the contractions become stronger and