



**South Valley University**



**Faculty of Science  
Zoology Department**

## **Microtechnique**

**Code: Zoo 211**

**Theoretical**

**Prepared by**

**Prof. Dr. Abdel-Nasser A. Hussein**

**Zoology Department, Faculty of Science**

**South Valley University**

**First semester**

**2023-2024**

## **Course Information**

**Title:** Michrotechnique

**Students:-** 2<sup>nd</sup> year- Special Zoology & Zoology and Chemistry

Faculty of Science. South Valley University

**Date:-** First semester 2023-2024

**Number of pages:-** 90

**Lecturer: Prof.Dr. Abdel-Nasser Ahmed Hussein**

**Zoology Department, Faculty of Science**

**South Valley University**

## **LECTURE SCHEDULE:-**

**Zoology Department, Room number:-**

	<b>Day</b>	<b>Date</b>	<b>Topic</b>
<b>01</b>			<b>INTRODUCTION</b>
			<b>MICROSCOPIC PREPARATIONS</b>
<b>02</b>			<b>REQUIREMENTS OF MICROSCOPIC PREPARATION A- TOOLS AND INSTRUMENTS</b>
<b>03</b>			<b>MICROSCOPY:- Light microscopes</b>
<b>04</b>			<b>MICROSCOPY:- Electron microscope</b>
<b>05</b>			<b>B- NARCOTIZATION AND FIXATION</b> a)- Narcotization b)- Separation of material
			c)- Fixation
<b>06</b>			
<b>07</b>			<b>Short Exam. 1 and discussion</b>
<b>08</b>			<b>C- BIOLOGICAL STAINS AND NATURE OF STAINING ACTION</b> a)- Stain
			b)- Staining
<b>09</b>			
<b>10</b>			<b>PREPARATION OF MICROSCOPIC SLIDES FOR LIGHT MICROSCOPE</b> 1- Smears 2- Squashes 3- Whole mounts
			4- Sections
<b>11</b>			
<b>12</b>			4- Sections
<b>13</b>			<b>PREPARATION OF SPECIMEN FOR ELECTRON MICROSCOPES</b>
<b>14</b>			<b>Final</b>
			<b>CHARACTERISTICS OF A GOOD SLIDE REFERENCES\ SUGGESTED READINGS LAB SAFETY PAST YEARS EXAMS</b>
			<b>Short Exam. 2 and discussion</b>

## INTRODUCTION

**THERE** are many techniques in **ZOOLOGY** used to prepare animal specimens for laboratory use. Those methods include collection of animals, anaesthetising and killing animals in the laboratory, and preservation and display of animal specimen. These methods include preservation in liquids, drying at room temperature or in hot air and freeze-drying and taxidermy. Also, include using common fixatives and stains. **Microtechnique** means the preparation of specimen to be clearly visible under different types of (optical and electron) microscopes. So **MICROTECHNIQUE** is the aggregate of the methods and procedures used for handling and preparing material for microscopic observation and study. Studying of the structure, vital activity, development, chemical composition, and physical properties of cells, tissues, and organs by means of optical and electron microscopes. Such techniques include the preparation of living specimens for microscopic examination; the preparation of permanent specimens; histochemical, and cytochemical studies; and special methods of preparing specimens for the electron microscope.

### **What is microtechnique used for?**

In the most basic way, **microtechnique** is used for anatomical description, identification, classification, and classical studies. However it has evolved into medical pathology, immunocytochemical and histochemical tests, and cell and molecular diagnostics.

## **MICROSCOPIC PREPARATIONS**

**Microscopic preparations** are the previously prepared objects (specimens) for examination using the microscope.

There are many types of microscopic preparations for light microscope, depending on aim of the study and kind of animal.

### **1- SMEAR**

**SMEAR** means spread out the tissue elements into very thin layer (film or smear). This method is employed for opaque fluid tissues such as the blood.

### **2- SQUASH**

**SQUASH** means spread out the soft tissues elements into very thin layer such as the testis and bone marrow.

### **3- TEASING**

**TEASING** means separation of the tissue elements with a fine needle. It is employed for tissues largely formed of fibers in order to secure individual fibers, such as muscle or nerve.

### **4- DISSOCIATING**

It is an act of disuniting or separating a complex object into parts.

It used to separate the tissue elements by any mechanical means or by chemical reagents, as saturated solution of boric acid.

**Example:-** separation of a double-stranded DNA molecule into its single strands, occurring when the hydrogen bonds connecting the two strands are broken (eg by heating).

### **5- WHOLE MOUNTS**

It means mounting a whole organism (specimen) or an organ on a slide for microscopic examination, such as parasites and insects. They include dry preparations (spines and shells), wet preparations those including stained and unstained preparations.

### **6- MICROSCOPIC SECTIONS**

This method is employed to cut the tissues into very thin slices (one or two cells thick). This method has the advantage of keeping the constituent cells undisturbed. In this case, whole animals or organs are cutting into sections (3-10 microns-  $\mu$ ).

### **7- PREPARATION OF LIVING CELLS**

It uses in special studies as tissue culture and some protozoa, gives us information those could not obtained from died (fixed) cells.

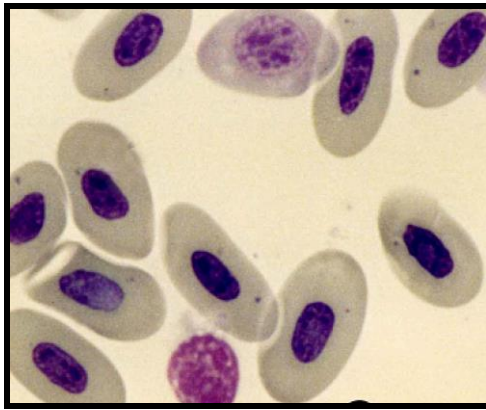

Blood smear of non-mammalian animal

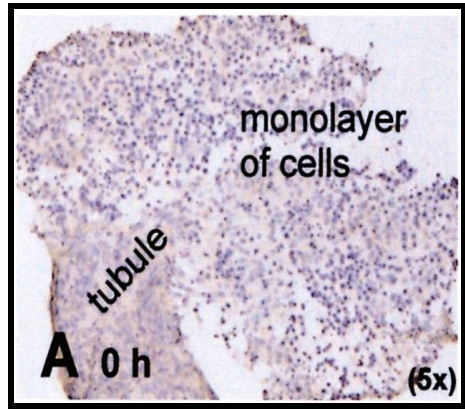

Squash of testis

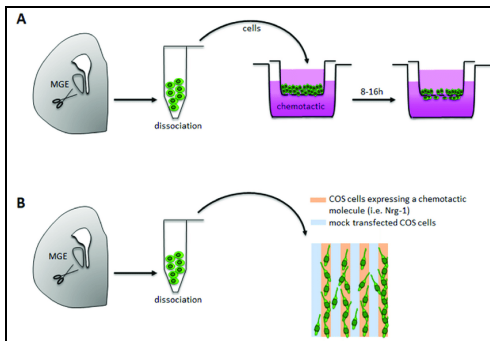

Tissue dissociation/primary cell isolation and cell harvesting are principal applications for enzymes in tissue culture research and cell biology studies.



Whole mount of skeletal muscle cells (or fibers) that have been teased apart

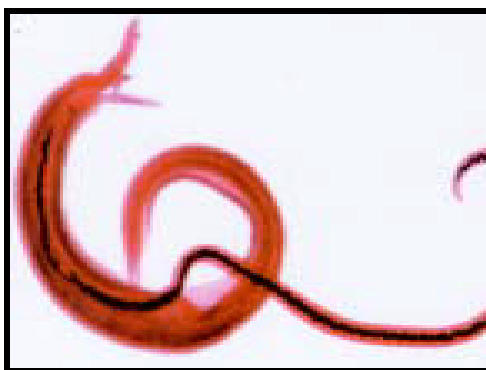

Whole mount of *Schistosoma*

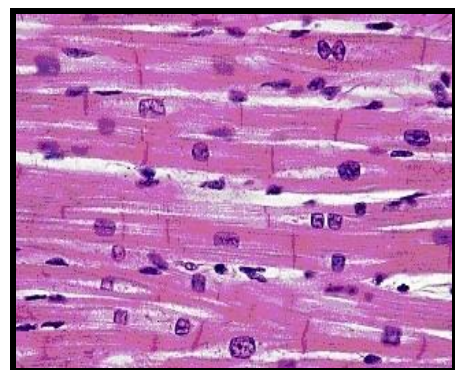

T.S in muscle

## **REQUIREMENTS OF MICROSCOPIC PREPARATION**

To achieve the project of microscopic preparation, there are many items need to be discussed to achieve this aim:-

**A- Tools and Instruments**

**B- Narcotization and Fixation**

**C- Biological stains and nature of staining action**

### **A- TOOLS AND INSTRUMENTS**

Microtechnique lab needs too many tools and a group of instruments in preparations of samples. They include:-

#### **01- MICROSCOPE**

It is a tool for examination of the specimen during and after preparation. Bright field microscopy is the simplest of all the light microscopy techniques. Magnification power about 2000 times the sizes of the objects.

#### **02- MICROTOME**

It is an instrument or cutting machine uses in sectioning of embedded specimens.

#### **03- CRYOSTAT**

It is a microtome but placed in cold box (in a freezer). It uses with tissues those should be processed in cold conditions (-30 °C).

The cryostat is usually used in a process called frozen section histology. The cryostat is essentially an ultrafine "deli-slicer", microtome. The cryostat is usually a stationary upright freezer, with an external wheel for rotating the microtome. The



temperature can be varied, depending on the tissue being cut - usually from minus 20 to minus 30 degree Celsius.

#### **04- AUTOMATIC TISSUE PROCESSOR**

It uses in a big laboratories to save time in manual transferring slides in preparations. An instrument designed for complete automatic dehydration and filtration tissues, up to final embedding in wax.

#### **05- INCUBATOR**

It uses in drying paraffin sections before staining and after mounting. Also it used to store solutions. An incubator is a device used to maintain optimal temperature, humidity and other conditions such as the carbon dioxide (CO<sub>2</sub>) and oxygen content of the atmosphere inside. Incubators are essential for a lot of experimental work and are used to culture micro-organisms.

#### **06- PARAFFIN OVEN**

It uses in melting wax and saturation of specimens with wax at 60 °C. Also to control temperature of the embedding medium, such as paraffin or wax. Temperature ranges + 30 °C to + 90 °C.

#### **07- HOT PLATE**

A hot plate is an adjustable heating source, which is ideal for heating beakers, flasks, hot water baths, and other flat-bottomed containers. There is very often a built in spinning magnetic stirrer (to be used in combination with a magnetic stir bar) so that you can efficiently stir a solution while heating. It uses in mounting sections at slides and temperature between 45-55 °C.

## **08- WATER DISTILLER**

Water distiller uses in distillation of water, which uses in solutions. Distilled water is water that has many of its impurities removed through distillation. Distillation involves boiling the water and then condensing the steam into a clean container.

## **09- P<sup>H</sup>- METER**

A p<sup>H</sup> meter is an electronic device used for measuring the p<sup>H</sup> (P<sup>H</sup> is the hydrogen ion concentration in liquid) of a liquid (though special probes are sometimes used to measure the p<sup>H</sup> of semi-solid substances).

A typical p<sup>H</sup> meter consists of a special measuring probe (a glass electrode) connected to an electronic meter that measures and displays the p<sup>H</sup> reading

Pure water has a p<sup>H</sup> very close to 7 at 25°C. Solutions with a p<sup>H</sup> less than 7 are acidic and solutions with a p<sup>H</sup> greater than 7 are basic or alkaline.

## **10- REFRIGERATOR**

A refrigerator maintains a temperature a few degrees above the freezing point of water. It uses to store solutions and chemicals.

## **11- ELECTRICAL BALANCE**

Electrical balance is more sensitive\accurate than normal balance, which shows the weight of a substance digitally and is used to weigh chemicals in labs.

## **12- THERMOMETER**

It is a device that measures temperature using a variety of different principles. A thermometer has two important elements: the temperature sensor (e.g. the bulb on a mercury thermometer) in which some physical change occurs with temperature, plus some means of converting this physical change into a numerical value (e.g. the scale on a mercury thermometer).

## **13- TURNTABLE**

It uses to close the ridges of glass covers when the mounting media are semi-liquid.

## **14- GLASS TOOLS**

**Staining jars:** are either for 2 slides or 10- 20 slides (coplin jars)

**Glass slides:** a microscope slide is a thin flat piece of glass, typically 75 by 25 mm (3 by 1 inch) and about 1 mm thick, used to hold objects for examination under a microscope.

**Covers** are using to cover mounted specimens (0.15-0.35 mm).

**Racks** are holders of staining jars and slides. **A staining rack** is a piece of equipment that holds several glass slides so that they can be dipped into a solution all at the same time.

**15- LITMUS PAPER:** it is used to quick determine the acidity or alkalinity ( $p^H$ ) of a solution.

Litmus is a water-soluble mixture of different dyes extracted from lichens (lichens are composite organisms consisting of a symbiotic relationship between a fungus and a photosynthetic partner), especially *Roccella tinctoria*. It is often

absorbed onto filter paper to produce one of the oldest forms of  $p^H$  indicator, used to test materials for acidity. Blue litmus paper turns red under acidic conditions and red litmus paper turns blue under basic (i.e. alkaline) conditions, with the color change occurring over the  $p^H$  range 4.5-8.3 at 25 °C.

Neutral litmus paper is purple. Red or pink litmus is used to test for basic solution and will turn blue in a basic solution. Blue litmus is used to test for acid and will turn pink in an acidic solution.

**16- SLIDE CABINET:** It used for storage the microscopic slides. Inside, convenient removable trays accommodate up to 82,000 microscope slides or 21,000 blocks. Coding strips can be used to separate slides or blocks by numbers.

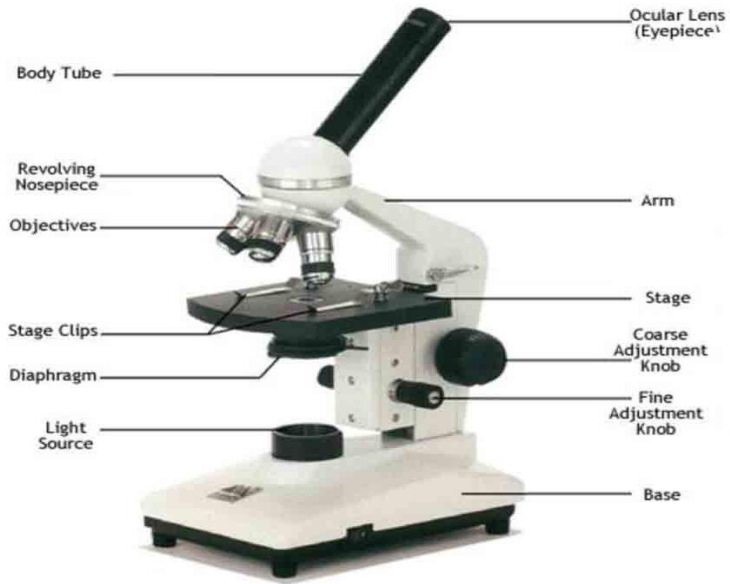

1- Microscope



2- Microtome



3- Cryostat



4- Automatic tissue processor



5- Incubator



6- Paraffin oven



7- Hot plate



8- Water distiller

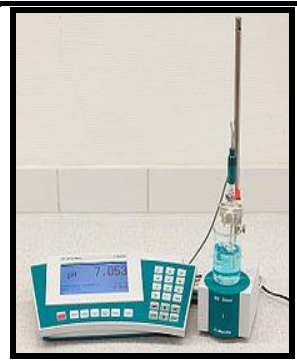

9- P<sup>H</sup>- meter



10- Refrigerator



11- Electrical balance

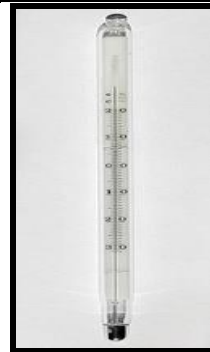

12- Thermometer



13- Turntable



14- Glass tools,  
Coplin jar

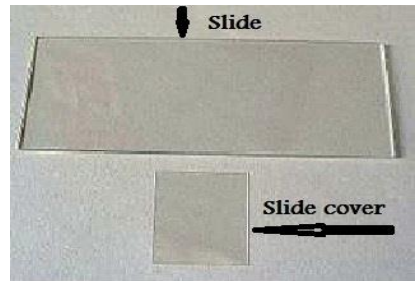

14- Glass tools, glass slides  
and covers



14- Glass tools, staining  
rack

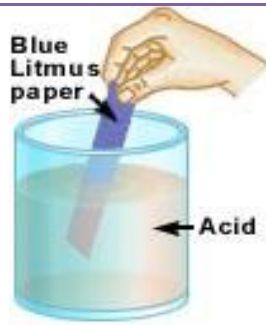

15- Litmus paper



16- Slide Cabinet

## **MICROSCOPY**

**MICROSCOPY** is a technique for producing visible images of structures or details too small to be seen by the human eye, using a microscope or other magnification tool. It is often used more specifically as a technique of using a microscope to view objects those cannot be seen with the unaided eye.

**MICROSCOPY** has evolved with the development of microscopes. Hence there are **TWO** well-known branches of microscopy: Light (optical) microscopes (LM) and Electron microscopes (EM).

**Light (Optical) microscope:** Light microscopy employs visible light to detect small objects. Light microscopy involves passing visible light transmitted through or reflected from the sample through a single or multiple lenses to allow a magnified view of the sample.

**Electron microscope:** In order to gain higher resolution, the use of an electron beam with a far shorter wavelength is used in electron microscopes. There are **two** main types of **EM**:-

**Transmission Electron Microscope (TEM):** Sending an electron beam through a very thin slice of the specimen. It gives a **2D** picture.

**Scanning Electron Microscope (SEM):** Visualizes details on the surfaces of specimens and gives a very good picture. It gives a very good **3D** picture.

**Note:- Wavelength** is the distance between one peak of a wave to the next corresponding peak, or between any two adjacent corresponding points, defined as the speed of a wave divided by its frequency.  $\lambda$  (**wavelength**) =  $v$  (**velocity**) /  $f$  (**frequency**)

## **HISTORY OF MICROSCOPY**

Many trails have been done (2000 up to 612 BC); the **CHINESE** use water microscopes made of a lens and a water-filled tube to visualize the unseen objects; the **ASSYRIANS** manufacture the world's oldest surviving lenses

Muslim scholar, **HASSAN BIN ALHAITHAM**, is the first use the simple microscope (**ALMEJHER**) and it contains only one lens. Then comes after, the Italian **GALILEO**, and then Dutch scholar, **LEEUVENHOEK**, they made simple microscopes. The English scientist **ROBERT HOOKE** made a compound microscope, as it contains more of the lens, and then follows the rest of the scientists.

**ZAKKARIAS JANSSEN (DUTCH- 1590)**, together with his father, **HANS JANSSEN**, constructed the first compound light microscope in Middleburg, Holland, around the year 1590.

**GALILEO GALILEI (ITALIAN- 1610)**, constructed microscopes with greater magnifying powers and studied the compound eyes of insects.



**MARCELLO MALPIGHI (ITALIAN-? DIED1694),**

microscopically studied animal and plant tissues in thin slices of several organs, earning the title of “The Father of microscopy and microscopic anatomy.

**ROBERT HOOKE (ENGLISH-1655),** designed a compound light

microscope with a magnifying power of about 42 times and studied, amongst other objects, a thin slice of cork discovering “cells”.

**ANTONY VAN LEEUWENHOEK (DUTCH, 1676),** designed

single lens (simple) light microscopes with magnifications approaching 300 times and observed protozoan and bacteria. He discovered red blood cells.

Microscopes developed in the 17th century, allowed us to re-evaluate our definition of life. Several types of microscopes play critical roles in cell biology.

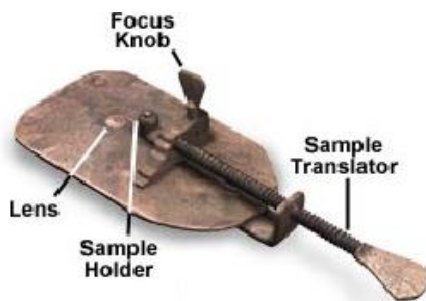

**Von Leeuwenhoek Microscope  
(circa Late 1600s)**



A simple microscope by Leeuwenhoek by The first compound microscope by Zacharias Jansen

## **LIGHT MICROSCOPE**

Simple instruments for low magnification, stereo microscope, a range of magnifications typically from 5X to 35 or 40X. The compound optical microscopes have high magnification up to 2000X, and used for micro-specimens. The stereo microscope is used for low magnification and to view specimens those are visible to the naked eye. It has:-

- **Bright light source.**
- **Set of lenses arranged to focus the image.**
- **A thin enough specimen for the passage of light.**

## **TYPES OF LIGHT MICROSCOPE**

### **A- Microscopes use visible light as Source of Illumination**

- (1)- Compound Light Microscope (Bright Light Microscope)
- (2)- Dark Light Microscope
- (3)- Phase – Contrast Microscope

### **B- Microscopes use ultraviolet light as source of illumination**

- (4)- Fluorescence Microscope

### **C- Microscopes use ultraviolet laser as source of illumination**

- (5)- Confocal Microscope

### **D- Other types of light microscopes**

- (6)- Ultraviolet Microscope
- (7)- Differential interference contrast Microscope

Better equipped labs may have dark field and/or phase contrast optics, **Nomarski** differential interference contrast (**Nomarski DIC**), **Hoffman modulation contrast**, and variations produce

considerable depth of resolution and a three dimensional effect. Fluorescence and confocal microscopes are specialized instruments, used for research, clinical, and industrial applications.

### **(1)- COMPOUND LIGHT MICROSCOPE**

The compound light microscope is also called a bright field microscope. Bright field microscopy is the simplest of all the light microscopy techniques. In the light microscope, bright light source, set of lenses, arranged to focus the image and specimen must be thin enough for the light. Sample illumination is via transmitted white light entering the microscope from a source in the base and passes through a condenser. A condenser converges the light beam so that they pass through the specimen. Bright field microscopy is best suited to viewing stained or naturally pigmented specimens such as stained prepared slides of tissue sections or living photosynthetic organisms. It is useless for living specimens of bacteria, and inferior for non-photosynthetic protists or metazoans, or unstained cell suspensions or tissue sections.

Best compound microscope has a resolving power of about 0.2 micrometer and a magnification power of about 2000 times the sizes of the objects. A compound microscope with a single eyepiece is known as **monocular**, one with two eyepieces is known as **binocular**.

In the past two or three decades the light microscope has been modified and improved in many ways. Lenses have not improved very much, but various contrast generating devices have

been added to improve the image quality, and many ways have been found for making microscopes into measuring instruments capable of yielding quantitative information of various kinds.

**Advantages:**

1. Simplicity of setup with only basic equipment required.
2. No sample preparation required, allowing viewing of living cells (but with bad contrast).

**Limitations:**

1. Very low contrast of most biological samples.
2. Low apparent resolution due the blur of out of focus material.

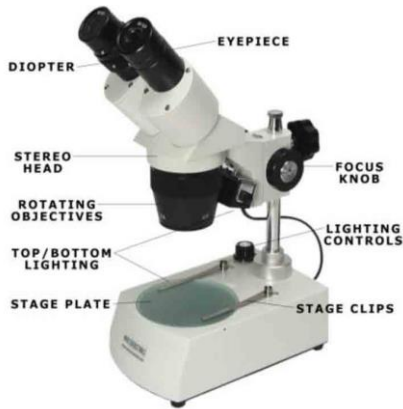

Stereo light microscope



Compound light microscope

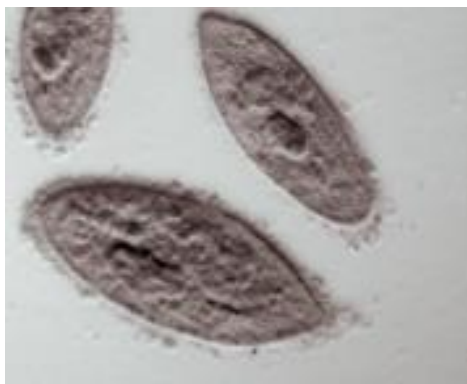
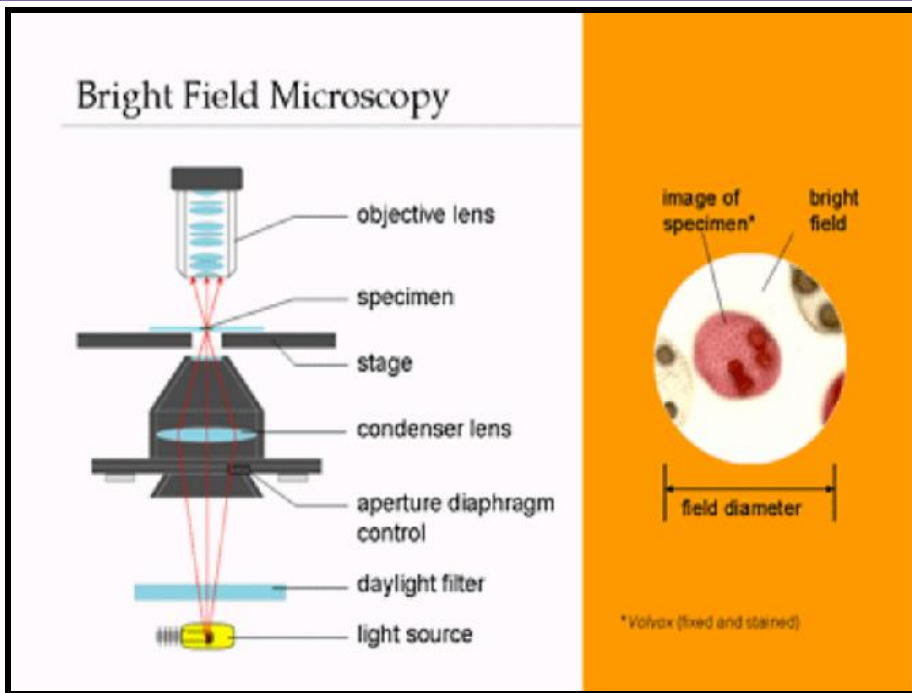

*Paramecium* image taken under light microscope

## **(2)- DARK FIELD MICROSCOPE**

**Dark field microscope (=Ultra-microscope)** was invented by Zsigmondy (1905). It uses a carefully certain light source to minimize the quantity of directly transmitted light (i.e. unscattered light) entering the image, and only collected light scattered by the sample. This is done by confining the illumination to a ring of light.

In dark field microscope, a special condenser lens is used with an opaque disc at the centre, so that direct rays don't enter the objective lens. Only light scattered by the specimen enter the objective lens to form a bright image against dark background. It is used in microbiology and in autoradiography.

### **Advantages:**

1. Clearly shows even transparent objects in the sample.
2. Simplicity of setup with only basic equipment required.
3. No sample preparation required, allowing viewing of living cells.

### **Limitations:**

1. Low light intensity in final image of many biological samples.
2. Low apparent resolution due the blur of out of focus objects.

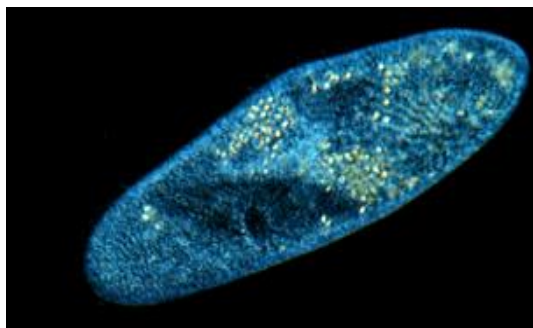
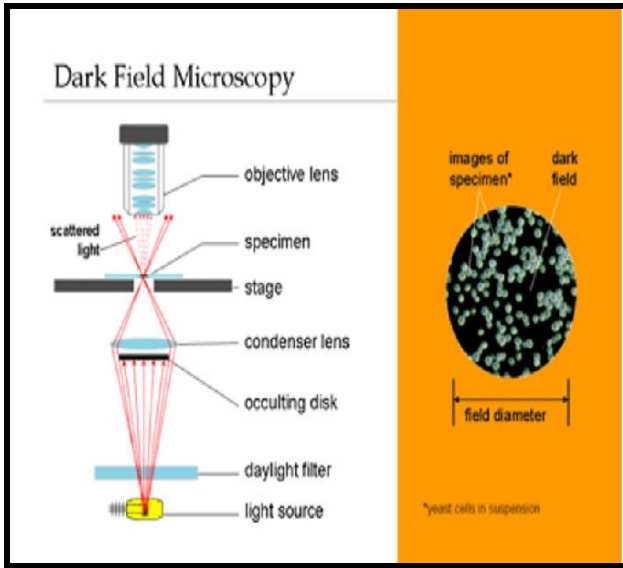

***Paramecium* image taken under dark field microscope**

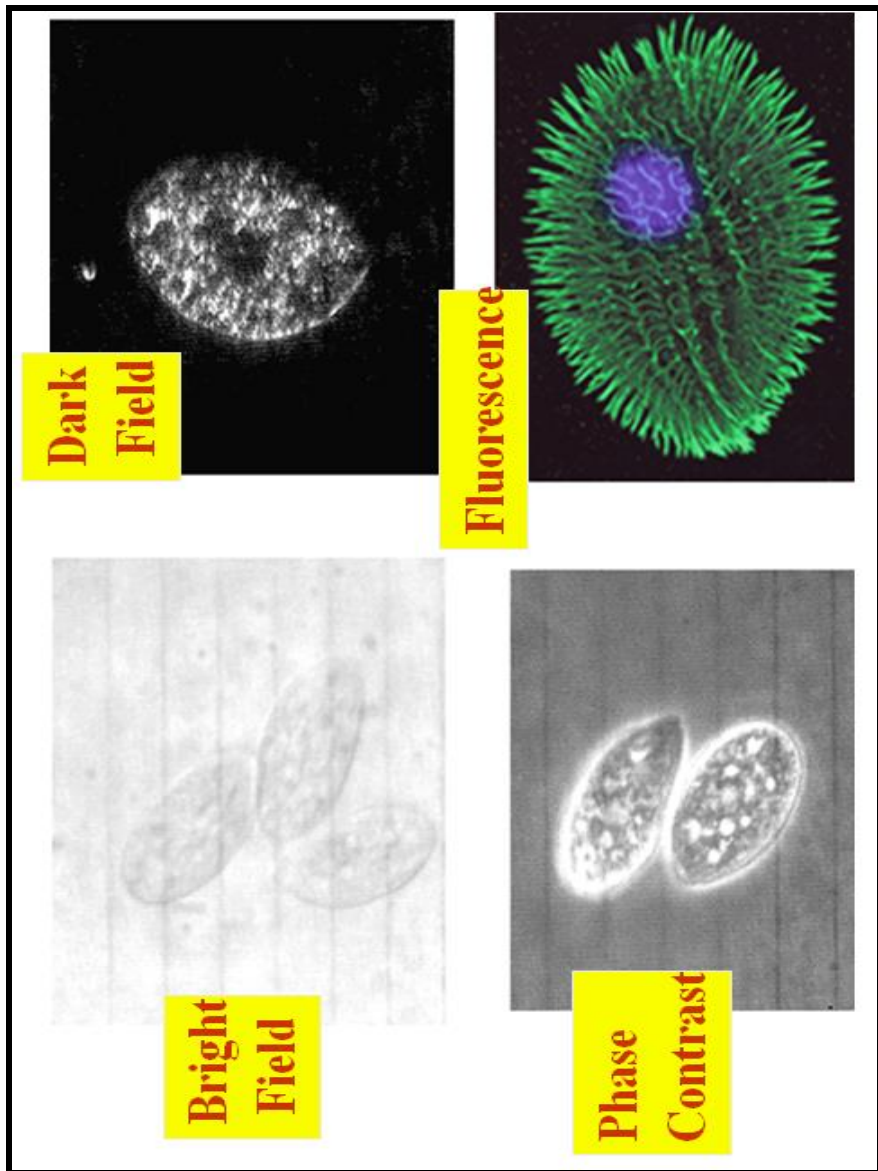

**Phase – Contrast Microscop**  
**Fluorescence Microscope**  
**Confocal Microscope**



## **ELECTRON MICROSCOPY (EM)**

An electron microscope is a type of microscope that uses electrons to illuminate a specimen and create an enlarged image.

The wavelength of the light limits the resolution to around 0.2 micrometers in light microscopy. In order to gain higher resolution (0.005  $\mu\text{m}$ ), the use of an electron beam with a far smaller wavelength is used in electron microscopes.

An electron microscope uses a beam of accelerated electrons as a source of illumination. Because the wavelength of an electron can be up to 100,000 times shorter than that of visible light photons, the electron microscope has a higher resolving power than a light microscope and can reveal the structure of smaller objects. Modern electron microscopes produce electron micrographs using specialized digital cameras and frame grabbers to capture the image. EM can achieve magnifications of up to about 10,000,000 x.

In EM, a high velocity beam of electrons (instead of light) is used to travel in a vacuum tube. The beam of electrons is focused by a series of electromagnetic lenses analogous to the condenser, objective and eye piece lenses of the light microscope.

The object is placed between the condenser and objective. The magnified image of the object is formed on the fluorescent screen or on photographic film rather than being observed through eye piece. Since the image produced by electrons does not have

the color, the electron micrograph always has shades of black, grey and white.

The objects under examination must be treated with chemicals or dyes to enhance the contrast. Techniques like negative staining, shadow casting and tracers are commonly used to increase the contrast.

Theoretically, the maximum resolution of the EM is 0.005 nm which is less than the diameter of a single atom, or 40,000 times the resolution of the light microscope and 2 million times that of the naked eye. However, the practical resolution of modern EM is of 0.1 nm.

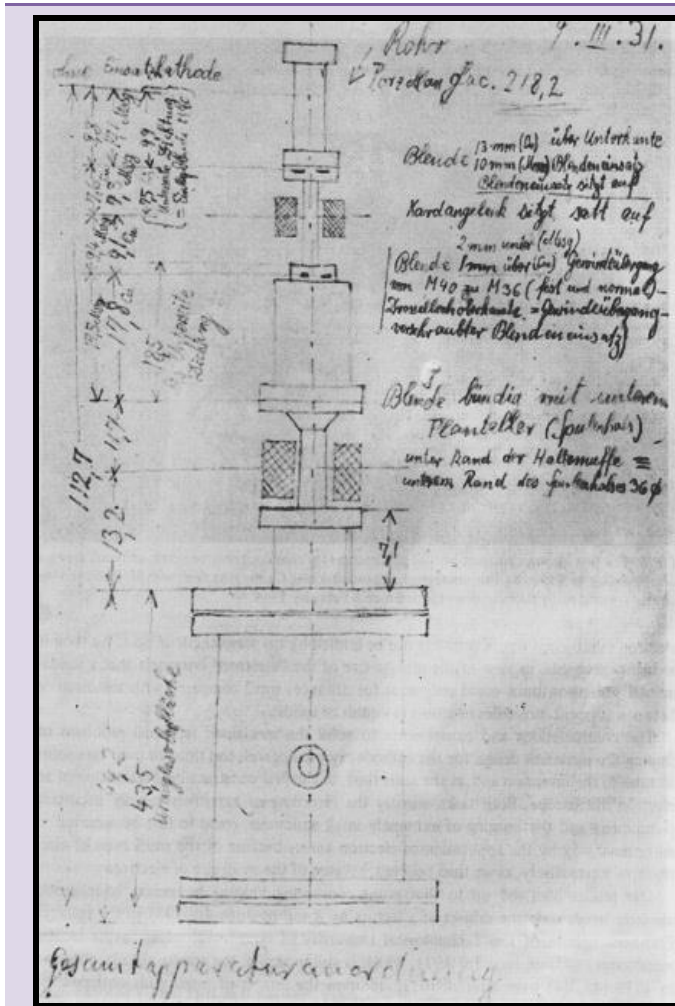

A sketch from Ernst Ruska's laboratory book, depicting the design of an early TEM prototype. With this group developing the first TEM with resolving power greater than that of light in 1933 and the first commercial TEM in 1939.



## History of Electron microscopes

## **GENERAL PRINCIPLE OF EM**

- A stream of electrons is shot towards the specimen.
- The stream is focused into a thin beam using the apertures and lenses of the microscope.
- The electron beam hits the specimen, and the microscope records how the electrons react.
- The electrons may pass through the specimen, or bounce off and scatter. Every interaction gives information about the structure and shape of the specimen. The microscope detects and measures this electron activity and a picture is created from this information.

## **TYPES OF ELECTRON MICROSCOPES**

Mainly, there are two types of electron microscopes:-

**Transmission electron microscopy (TEM)**

**Scanning electron microscopy (SEM)**

## **TRANSMISSION ELECTRON MICROSCOPY (TEM)**

It is the original form of electron microscope. The first TEM was built by two German scientists, **Max Knoll** and **Ernst Ruska** in 1931. It is principally quite similar to the compound light microscope, by sending an electron beam through a very thin slice of the specimen. The resolution limit is about 0.05 nanometer.

A transmission electron microscope can achieve better than 50 pm (Picometer is a unit of length in the metric system, equal to one trillionth (i.e.,  $1 \times 10^{-12}$  m) of a meter) resolution and magnifications of up to about 10,000,000X.

## **STRUCTURAL PARTS OF TEM**

### **(a) Electron gun**

It consists of a tungsten filament or cathode that emits electrons on receiving high voltage electric current (50,000-100,000 volts). Near the top of the tube is an anode which attracts electrons.

### **(b) Ray tube (Microscope Column)**

It is a high vacuum metal tube (2mt. high) through which electrons travel.

### **(c) Condense lens**

It is the electromagnetic coil, which focuses the electron beam in the plane of the specimen.

### **(d) Objective lens**

It is the electromagnetic coil, which produces the first magnified image formed by the objective lens and produces the final image.

### **(e) Projector lens**

It is also an electromagnetic coil, which further magnifies the first image formed by the objective lens and produces the final image. Each electromagnetic coil has a coil of wire encased by a soft iron casing.

### **(f) Fluorescent Screen or Photographic Film**

Since unaided human eye cannot observe electrons, therefore, a fluorescent screen is used for viewing the final

image of the specimen. The final image obtained is called an electron micrograph.



**A modern transmission electron microscope**

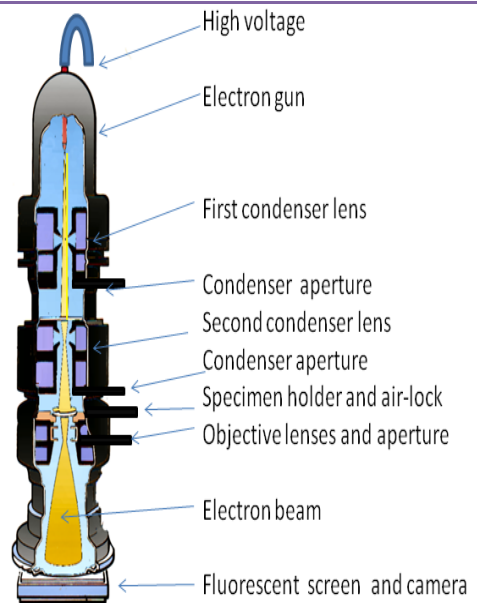
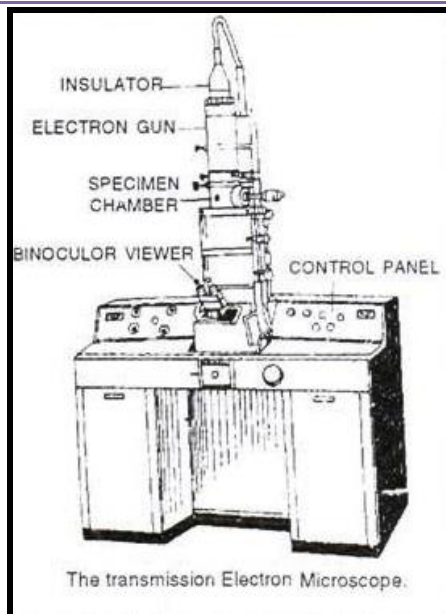

**Diagram of a transmission electron microscope**

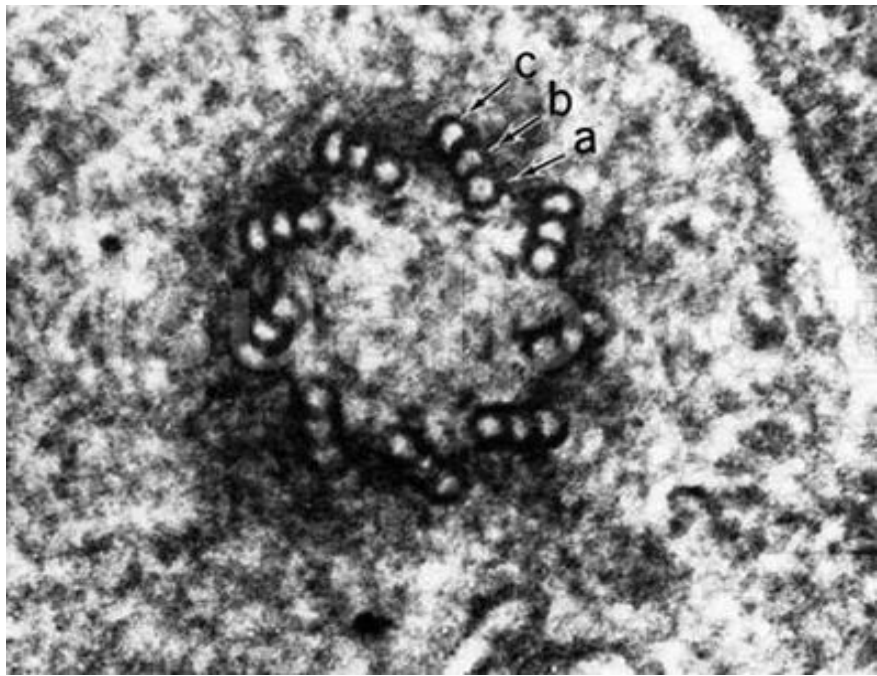

**Microtubule-triplets in centriole- TEM**

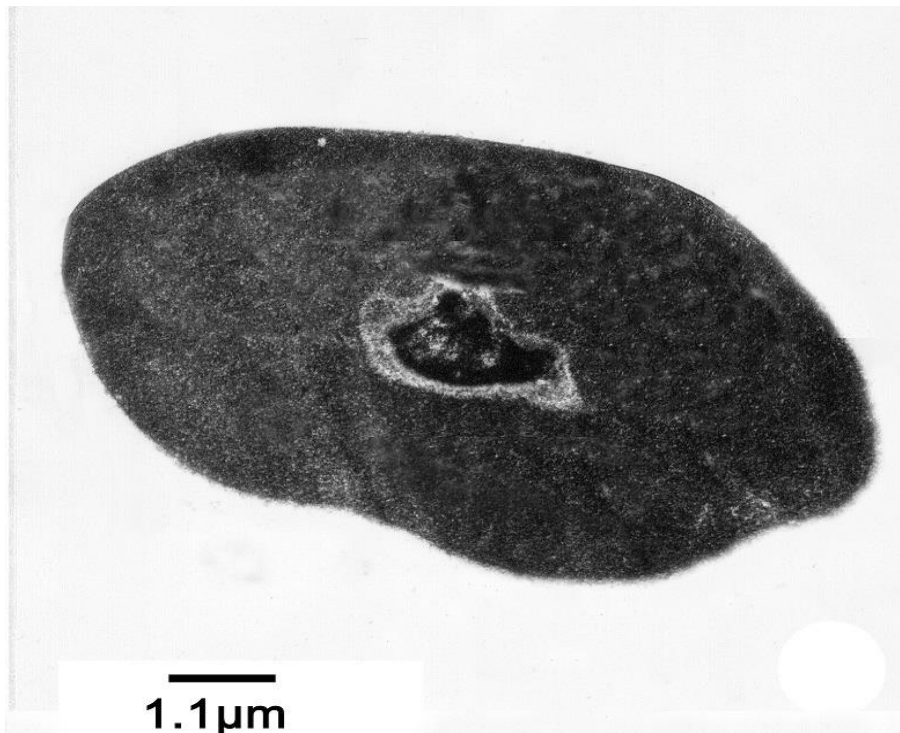

**An erythrocyte- TEM**

## **ADVANTAGES OF TEM**

1. TEM has a high magnification and resolving power.
2. Without the aid of TEM, biologists would have never known submicroscopic cell organelles (e.g., ribosomes, microbodies, centrioles, microtubules, endoplasmic reticulum) and internal structure of microscopic organelles (e.g., chloroplasts, mitochondria).
3. Study of microorganisms and viruses have been possible only with the aid of TEM.
4. It can discern even macromolecules. This has helped scientists to know the arrangement of molecular aggregates and even their components, e.g. nucleosomes.

## **DISADVANTAGES OF TEM**

- 1- It is complicated and costly.
- 2- There is risk of radiation leak.
- 3- Require very high voltage electric current.
- 4- A cooling system is required.
- 5- The specimen or object has to be given special treatment including complete dehydration.
- 6- The major disadvantage of the transmission electron microscope is the need for extremely thin sections of the specimens, typically about 100 nanometers. Electrons are unable to pass through thick specimens. Biological specimens are typically required to be chemically fixed,



dehydrated and embedded in a polymer resin to stabilize them sufficiently to allow ultrathin sectioning.

- 7- Sections of biological specimens may require special treatment with heavy atom labels in order to achieve the required image contrast.
- 8- Resolution of the TEM is limited primarily by spherical aberration, but a new generation of aberration correctors has been able to partially overcome spherical aberration to increase resolution. Hardware correction of spherical aberration for the high-resolution transmission electron microscopy (HRTEM) has allowed the production of images with resolution below 0.5 angstrom (50 picometres) and magnifications above 50 million times. The ability to determine the positions of atoms within materials has made the HRTEM an important tool for nano-technologies research and development.

### **SCANNING ELECTRON MICROSCOPY (SEM)**

It is the second type of EM. Although **Max Knoll** produced a photo with a 50 mm object-field-width showing channeling contrasts by the use of an electron beam scanner. **Manfred von Ardenne** who in 1937 invented a true microscope with high magnification by scanning a very small raster with a demagnified and finely focused electron beam.

It is smaller and simpler than TEM. Whereas the TEM uses electrons that have passed through the concerned object to form an image, the SEM uses electrons that are scattered or emitted from the surface of the object.

It is used to study the three dimensional (3D) images of the surfaces of cells, tissues or particles. The SEM allows viewing the surfaces of specimens without sectioning. Its most useful magnification is in the lower range than that of the transmission electron microscope.

### **STRUCTURAL PARTS OF A SEM**

Essential components of all SEM include the following:

- 1- Electron source ("Gun")**
- 2- Electron lenses**
- 3- Sample stage**
- 4- Detectors for all signals of interest**
- 5- Display / Data output devices**
- 6- Infrastructure requirements**
- 7- Power supply**
- 8- Vacuum system**
- 9- Cooling system**
- 10- Vibration-free floor**
- 11- Room free of ambient magnetic and electric fields.**

SEMs always have at least one detector (usually a secondary electron detector), and most have additional detectors. The

specific capabilities of a particular instrument are critically dependent on which detectors it accommodates.



Scanning electron microscopy (SEM)

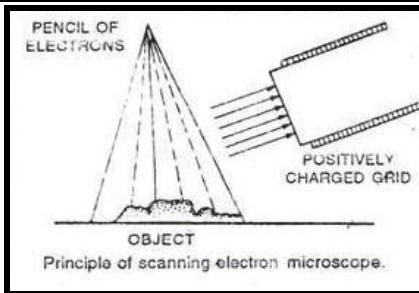
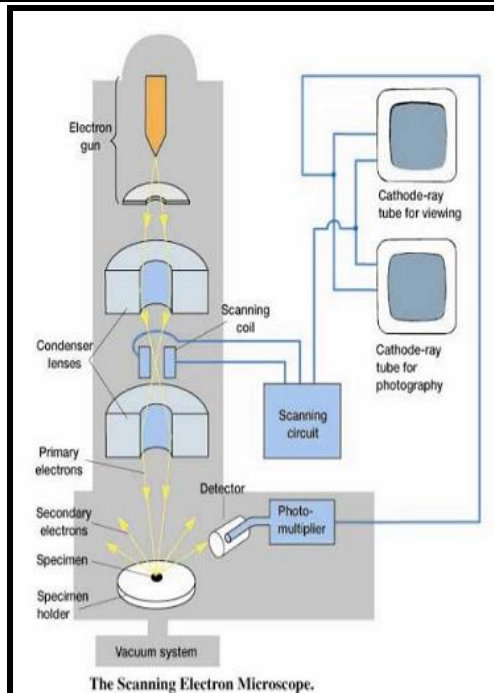
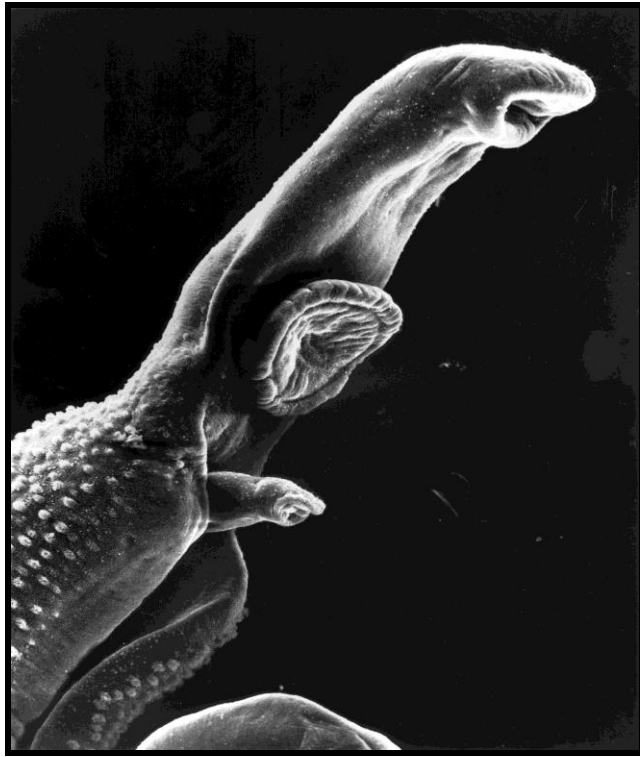

Diagram of a scanning electron microscope



The Scanning Electron Microscope.



*Schistosoma*- SEM

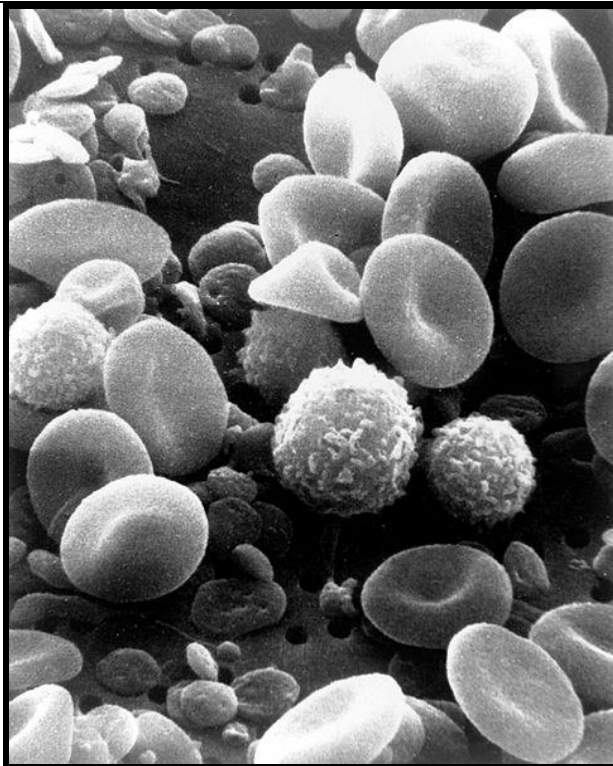

Blood corpuscles- SEM

## **ADVANTAGES OF SEM**

1. Most SEM's are comparatively easy to operate, with user-friendly "intuitive" interfaces.
2. Many applications require minimal sample preparation.
3. For many applications, data acquisition is rapid (less than 5 minutes/image for SEI, BSE, spot EDS analyses.)
4. Modern SEMs generate data in digital formats, which are highly portable.
5. Because the SEM image relies on surface processes, it is able to image bulk samples up to many centimeters in size and has a great depth of field, and so can produce images that are good representations of the three-dimensional shape of the sample.
6. Another advantage of SEM is its variety called environmental scanning electron microscope (ESEM) can produce images of sufficient quality and resolution with the samples being wet or contained in low vacuum or gas. This greatly facilitates imaging biological samples that are unstable in the high vacuum of conventional electron microscopes.

## **DISADVANTAGES OF SEM**

1. Generally, the image resolution of an SEM is poorer than that of a TEM.
2. Samples must be solid and they must fit into the microscope chamber. Maximum size in horizontal dimensions is usually

on the order of 10 mm; vertical dimensions are generally much more limited and rarely exceed 40 mm. For most instruments samples must be stable in a vacuum.

3. Samples likely to outgas at low pressures (rocks saturated with hydrocarbons, "wet" samples such as coal, organic materials or swelling clays, and samples likely to decrepitate at low pressure) are unsuitable for examination in conventional SEM's. However, "low vacuum" and "environmental" SEMs also exist, and many of these types of samples can be successfully examined in these specialized instruments.
4. EDS detectors on SEM's cannot detect very light elements (H, He, and Li), and many instruments cannot detect elements with atomic numbers less than 11 (Na).
5. Most SEMs use a solid state x-ray detector (EDS), and while these detectors are very fast and easy to utilize, they have relatively poor energy resolution and sensitivity to elements present in low abundances.
6. An electrically conductive coating must be applied to electrically insulating samples for study in conventional SEM's, unless the instrument is capable of operation in a low vacuum mode.

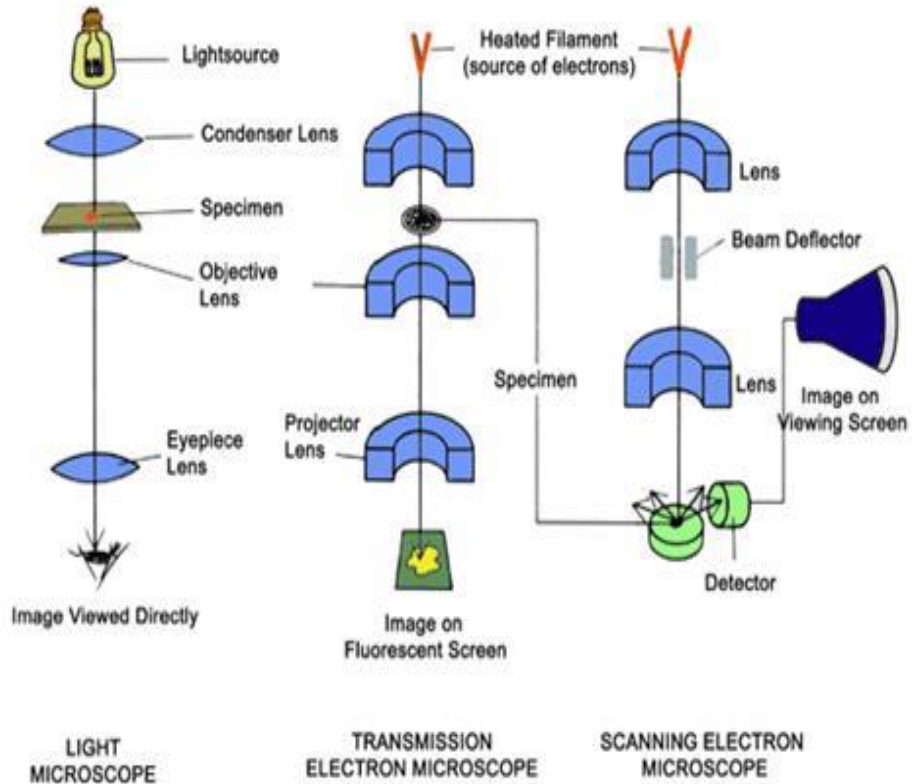

Principal features of LM, TEM, and SEM

	<p><b>Differences between light (optical) microscope and electron microscope</b></p>
--	--------------------------------------------------------------------------------------

## **B- NARCOTIZATION AND FIXATION**

The animals must be immobilized before tissues can be dissected out for examination.

The organs – those have to be studied - should be removed immediately from the body and placed in an appropriate fixative solution.

### **A) - Narcotization (anaesthetizing)**

The narcotic substance is any psychoactive compound with relieved pain, dulled the senses, or induced sleep, such as chloroform, ether, or Nembutal. The animals must be immobilized through narcotic substances before tissue or organ can be dissected out.

Narcotization is important in separation of material for routine studies, but alternations always occurred in nervous system. Also in histochemistry, cytology, and delicate cell organelles (e.g. mitochondria) narcotization is not preferable, because these substances cause alternations in tissue composition. So, the animal should be killed by a blow on the head or by cutting the head and anesthetics should be avoided, if possible.

In a case of **big mammals** as dogs and cats, animal should be slaughtered after narcotization with ether or chloroform. Small mammals should be killed, slaughtered or pithing. In a case of **reptiles**, the head should be cut with strong scissors. **Amphibians**,



either killed by knocking or pithing or by anaesthetizing. There are many **narcotic substances** usually used:-

**01- 10% Alcohol**

It uses with fresh-water animals as *Hydra* and *Turbellaria*.  
Alcohol adds to water gradually.

**02- Magnesium chloride**

Mainly, uses with marine animals as Actinozoa (7.5%) but with freshwater animal should be 2.5%.

**03- Magnesium sulphate**

Few crystals are adding to water where animals are living.  
It uses with all invertebrate animals in both marine and fresh water habitats.

**04- Mentol**

It is uses with setting animals in fresh water and marine habitats.

**05- Ether vapours**

It uses with land vertebrates and insects and wasp.

**06- Chloral hydrate**

Crystals of chloral hydrate are adding to water where the animal lives, such as *Hydra* and *Turbellaria*.

**07- Tobacco smoke**

It uses with ciliated protozoa (*Paramecium*), flagellates and *Hydra*.

**08- Chloroform (Acetone + chloroform)**

Better use with invertebrate as general.

## 09- Asphyxiation

It uses with snails, where snails put in cooled boiled-water in closed bottles.

### Separation of material

The recommended way of separation is dissection of animal in suitable physiological solution. The organs should be removed immediately from the body and placed in an appropriate fixative solution. Degenerative cytological changes begin as soon as the animal dies. One of the most common physiological solutions is “**Ringer’s solution**”. The composition is different with different animals:-

#### **Ringer’s solution**

With **Homiothermal**, hot-blooded animals (Birds and Mammals)

Sodium chloride	8.5 gm
Potassium chloride	0.25 gm
Calcium chloride	0.25 gm
Sodium bicarbonate	0.25 gm
Distilled water	1000 cm <sup>3</sup>

With **Poikelo thermal**, cold-blooded animals (fishes, amphibia, reptiles), the quantity of Sodium chloride reduced to 6.5 gm

**Note:-** Sodium chloride (0.75%) can be use with poikelo thermal and 0.90% with homiothermal animals.

### Considerations in separation of material

There are many considerations have to be in mind in separation of material!

- 1- Washing of the tissue in physiological solution
- 2- Organ should not be under pressure with forceps
- 3- Organ should not be air-dryness
- 4- Pieces of organ have to be with equal surfaces (0.5cm) using sharp scalpel

## **B) – Fixation**

It means killing and fixing the structural details of the cells and tissues also should harden them. Generally, fixative consists of many chemical substances (except alcohol and formalin).

The tissues should be placed in a fixative solution for "lifelike" conditions and for preservation of cellular structure. So, fixatives perform a number of important functions.

### **The aim of fixation? (Functions of fixative)**

- 1- Prevents putrefaction and autolysis and thus keeps the tissues very near to their normal structure.
- 2- Hardens the tissues
- 3- Makes staining easier

After fixation the excess fixative must be removed by putting the pieces of tissues in running tap water.

### **Advantages of a good fixative**

The good fixative has to be:-

- 1- Quick diffusion of the tissues to prevents analytical changes (autolysis).
- 2- Conversion of the soluble constituents into non-soluble substances.

3- The tissues are kept unchanged as much as possible with the subsequent treatment (dehydration, mounting and sectioning).

4- Hardening of the tissues

5- It makes parts of the tissues easier in differentiation during staining.

### **Time of fixation**

Time of fixation depends on type and thickness of the sample, age of animal, and type of fixative.

### **Considerations in fixation process**

There are many considerations have to be in mind in fixation process!

a) - Put the sample in the fixative as soon as possible.

b) - A suitable quantity of fixative (20 times of sample).

c) - Shake the bottle of fixative containing the samples during fixation process.

### **Types of fixatives**

There are many fixatives usually used:-

#### **1)- Bouin Solution (aqueous Bouin)**

Preparation:

Saturated aqueous solution of picric acid 75 ml

Formaldehyde (37-40%) 25 ml

Glacial acetic acid 5 ml

Time of fixation is 24 hours; it uses for preserving soft and delicate structures such as brain tissues. It should not be used with DNA or in fixation of cytoplasm components.

## **2)– Formalin Solution (10%, unbuffered):**

**Formalin** is an aqueous solution (37%) of formaldehyde. **Formalin** formerly used as disinfectants and for preservation of biological specimens.

### **Preparation:**

Formaldehyde (37-40%)	10 ml
Distilled water	90 ml

Time of fixation is 24 hours. It uses in whole mounts and in fixation of nervous tissues and lipids. It is better to use formalin as a part of fixative not a single one, such as 10% formol saline, formol Alcohol, 10% neutral buffered formalin and formol calcium.

Commercially available solutions are unsuitable for electron microscopy because of their content of methanol (to prevent polymerization when diluted to 2-4%). Paraformaldehyde powder is used to prepare methanol-free formaldehyde. Main advantage of formaldehyde (called **methanal**) is that it has a higher rate of penetration than either glutaraldehyde or osmium tetroxide so that large blocks of tissue are well fixed. It will penetrate most tissues at a rate of about 10 mm / hour, but will take a longer time to stabilize the tissue.

### **3) – Alcohols (Alcohol)**

It is used when the sample dissolves in water (as glycogen). Time of fixation is 24 hours. It causes dryness and constriction of the samples. Methyl alcohol is used in fixation of blood films (smears).

### **4) - Glutaraldehyde.**

Glutaraldehyde is used in biological electron microscopy as a fixative. It kills cells quickly by crosslinking their proteins and is usually employed alone or mixed with formaldehyde as the first of two fixative processes to stabilize specimens such as bacteria, plant material, and human cells. A second fixative procedure uses osmium tetroxide to crosslink and stabilize cell and organelle membrane lipids. Fixation is usually followed by dehydration of the tissue in ethanol or acetone, followed by embedding in an epoxy resin or acrylic resin.

Reacts rapidly with proteins and that, being a dialdehyde, stabilizes structures by cross-linking before there is any opportunity for extraction by the buffer. Hence more ground substance of the cytoplasm (glycogen) and of the extracellular matrices is preserved. Depth of penetration is 2 - 3 mm / hour.

### **5) - Osmium peroxide**

The solution (yellow color), reacts with lipids and also acts as a stain, osmium will penetrate most tissues at a rate of about 1mm / hour. Extended times will cause extraction of many proteins, therefore keep time of immersion to a minimum.

## **The effects of fixation upon staining**

Fixation assists the interaction of tissues and dyes. Chromatin is probably split into DNA and protein by fixation, allowing the DNA to be stained by a basic dye. Mercuric chloride, formaldehyde, and ethyl alcohol appear to act in this way. Proteins are also more easily stained after fixation: formaldehyde and mercuric chloride favour basic dyes, whilst trichloroacetic acid, picric acid, and chromium compounds facilitate the action of acidic dyes. After fixation with ethyl alcohol or acetic acid, both basic and acidic dyes are taken up by the tissues easily.

## **C- BIOLOGICAL STAINS AND NATURE OF STAINING ACTION**

### **a) - Stain**

Under the bright field microscope, most tissue components (extracellular materials, cells and their organelles, etc.) lack sufficient contrast to be distinguished by the human eye. Stains are chemical compounds (dyes) used to enhance the visibility of a microscopic object or organism. They are used in biology and medicine for staining sections to differentiate the various structures as they take different colors for viewing, often with the aid of different microscopes. No single stain can be used to reveal all what you want to know about a tissue.

The type of stain and the technique you use depends on what you're looking at, what structure you're looking for and what you want the staining procedure to accomplish.

Generally, two or three different stains, which will selectively color different components of the tissue. For general work, two stains of contrasting color are used; typically these are known as the stain and the counterstain and differentiate between the nucleus and the cytoplasm respectively. Most commonly used in this manner are the haematoxylin nuclear stain and then any one of a number of counterstains to color the cytoplasm. Some staining reactions are well understood; others are not. You should attempt to understand as much as possible about each one we will attempt. This will enable you to get a better stain and to know what to change when something goes wrong.

**A counterstain** (or double staining):- is the application of two stains to color different parts of the specimen. It means, a second stain of a different color applied to a microscopic specimen and used to color and contrast those parts not retaining the first stain, making the stained structure more easily visible. So, a counterstain is stain that makes cells or structures more visible, when not completely visible with the principal stain.

**Example:-** Eosin is a counterstain to haematoxylin in the H&E stain. Although it is possible to distinguish considerable detail in unstained (either living or fixed) cells, contrast between cell structures is usually poor.



Application of suitable staining techniques will make cell organelles clearly visible and may aid in identification of the chemical components of these structures.

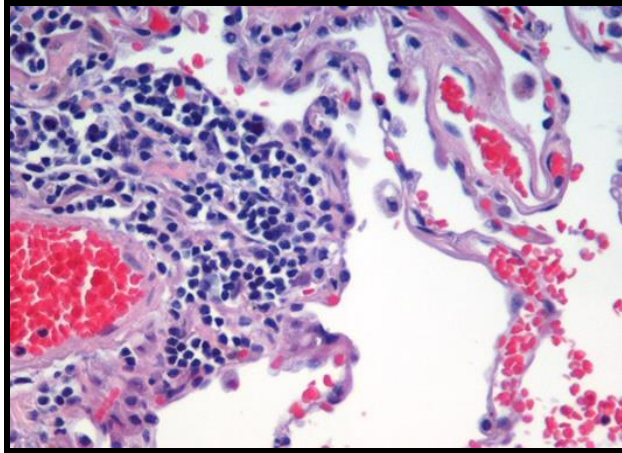

Image is of H&E (haematoxylin and eosin) stained lung tissue sample. Cell nuclei are blue-purple, red blood cells are red, other cell bodies and extracellular material are pink, and air spaces are white.

**Note:-** Most of the dyes commonly used in microscopy are available as **certified stains**. This means that samples of the manufacturer's batch have been tested by an independent body, **the Biological Stain Commission**, and found to meet or exceed certain standards of purity, dye content and performance in staining techniques. These standards are published in detail in the **journal Biotechnic & Histochemistry**. Many dyes are inconsistent in composition from one supplier to another. The use of certified stains eliminates a source of unexpected results.

### **Nomenclature of stains**

There is no a single system in nomenclature of stains but usually depends on the color, such as methyl green and toluidine blue.

## **Types of stains**

Most stains are organic salts consisting of a positive and negative ion. Generally, histological stains are consisting of base radical and acid radical. The staining action comes after decompose (in liquid media) of the stain into those two parts. Histochemically, there are two types of stains:-

**a)- Natural dyes    b)- Synthetic dyes**

### **A)- Natural dyes:**

They are natural products, such as carmine and Haematoxylin.

**Carmine or Cochineal**, A red dye recovered from the dried and pulverized bodies of female cochineal insects (*Dactylopius cacti*) (cells of lipids of female insects called cochineal). Those insects are living in middle-America. These insects feed on juice of certain plant (*Nopalea coccinellifera*) which called nopal. Carmine has the ability of staining by adding some metals such as iron or aluminum.

**Notice:-** The females of **cochineal** insects are wingless and about 5 mm (0.20 inch) long, cluster on cactus pads. They penetrate the cactus with their beak-like mouthparts and feed on its juices, remaining immobile unless alarmed. After mating, the fertilized female increases in size and gives birth to tiny nymphs. The nymphs secrete a waxy white substance over their bodies for protection from water loss and excessive sun. This substance makes the cochineal insect appear white or grey from the outside, though the body of the insect and its nymphs

produces the red pigment, which makes the insides of the insect look dark purple. Adult males can be distinguished from females in that males have wings, and are much smaller.

**Haematoxylin**, is extracted from wood of small tree called *Haematoxylum campechianum*, in south of Mexico and Jamaica. The extracted substance has the ability of staining after oxidation into hematein, which oxidized either natural (exposed to air) or by adding some chemicals (mercuric oxide). According to the different ways of preparations, there are many solutions of haematoxylin (such as Delafield, Ehrlich, Harris and Mayer).

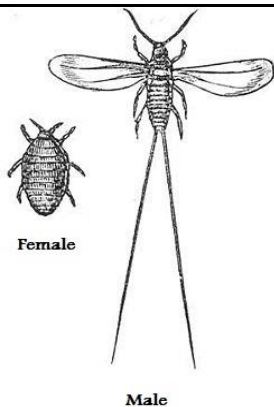

Female (left) and male (right) cochineals



Crushed *Dactylopius*



*Haematoxylum campechianum*

---

## **b)- Synthetic dyes:**

**Synthetic dyes** are organic dye compounds originally derived from coal tar derivatives; presently produced by synthesis from benzene and its derivatives. Chemically, there are three parts of synthetic dye (Chromophores, Chromogens and Auxochromes).

Chemically a dye (stain) may be defined as an organic unsaturated cyclic compound with **chromophore** and **auxochrome** group. The colour is usually due to chromophore and dyeing property of salt formation is due to **auxochrome**.

A chemical possessing only chromophore group may be a good **chromogen** (Colored compound) but may not be a good stain/dye unless and until it has an auxochrome group. Without an auxochrome group the chromogen is not able to bind to cells or tissues or fibers. The ability of a stain to bind to macromolecular cellular components depends on the electrical charge found on the **chromogen** portion as well as on the cellular components to be stained. **Examples** of synthetic dyes include **eosin**, **methylene blue**, and **fluorescein**. Chemically, there are **three** parts of synthetic dye:-

**Chromophores:** They are colorless substances in absence of chromogens and auxochromes. Chromophore is a part of the molecule of a dye responsible for its color. They absorb light at a specific frequency and so imparts color to a molecule. Nomenclature of the produced dye depends on

this part. Such as  $\text{NO}_2$ ;  $\text{N}_2$ ; or  $\text{O}_2$ , this imparts some decided color to the compound of which it is an ingredient.

**Chromogens:** They are any substance lacks color found in organic fluids that forms colored compounds when oxidized. This is a compound not a dye but containing chromophores within its components. E.g. **Stercobilinogen, (urobilinogen)** is a chromogen formed in the intestine from the breakdown of bilirubin; yields urobilins on oxidation; some is excreted in the feces and some is absorbed and excreted in bile or urine. **Diaminobenzidine** (0. 05% Sigma) with nickel chloride (0. 04%) was used as chromogen.

**Auxochromes:** It is a group of atoms attached to a chromophore. It modifies the ability of chromophore to absorb light. They themselves fail to produce the color; but when present along with the chromophores in an organic compound intensifies the color of the chromogen, where an auxochrome helps a dye to bind to the object that is to be colored. It increases the color of any organic compound. Those are giving electrons (donators), such as **hydroxyl group (-OH)** (acidic auxochrome) and **amino group (-NH<sub>2</sub>)** as basic auxochrome. They change colorless substance into colored one. There are **two** types of auxochromes:

**Acidic:** such as -OH (hydroxyl group), -SO<sub>2</sub>H (sulphonic group), -COOH (Carboxylic group)

**Basic:** such as  $\text{-NH}_2$  (amino group),  $\text{-NHR}$  (alkylamino group),  $\text{-NHR}_2$  (dialkylamino group)

Benzene does not display color as it does not have a chromophore; but nitrobenzene is pale yellow color because of the presence of a nitro group ( $\text{-NO}_2$ ) which acts as a chromophore.

The **auxochrome** group of **crystal violet** is the charged carbon in the center of the molecule. This is typically neutralized by a  $\text{Cl}^-$  ion. The **chromophore** group consists of the three benzene rings and the central carbon. These structures readily absorb light.

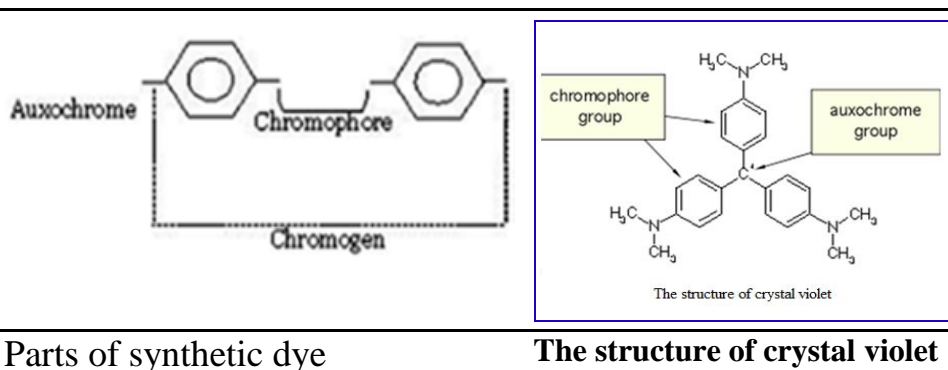

## **Types of stains (dyes)**

According to the action of a stain, there are basic, acidic and neutral stains.

**Basic stain:** In basic stains the color comes from an organic cation (a positively charged ion). It contains colored base radical that combined with colorless acid radical. It is soluble in both water and alcohol. It stains **acidic** structures (basophilic substance) in the tissue, such as **nuclei** and ribosomes, with blue - pink color.

**E.g. haematoxylin (Hx), and basic fuchsin.**

**Acidic stain:** In acid stains the color comes from an organic anion (a negative charged ion). It contains colored acid radical that combined with colorless base radical. It stains **basic** structures (acidophilic substance) in the tissue, such as **cytoplasm** with red color. It is soluble in both water and alcohol. A substance stained with **E.** is called acidophilic substance. The coloring power of acidic dye e.g. eosin in sodium eosinate is having negative charge; therefore, it does not combine with the negatively charged bacterial cell surface.

**E.g. Eosin (E) and acidic fuchsin.**

**Neutral stain:** Neutral stains are mixtures of acidic and basic stains and are used to stain both acidic and basic structures (nucleus and cytoplasm). It is soluble in alcohol and rarely in water.

**E.g Geimsa stain**, which is formed of methylene blue (basic) and eosin (acidic).

**E.g. Leishman's stain**, it is made by mixing the acid stain eosin with the basic stain methylene blue in alcohol. In which, the anion (negative ion) and cation (positive ion) each contains a chromophore group.



**Metachromasia (Metachromatic stain):**  
**Orthochromatic stain**  
**Polychromasia (multi – colored dye):**



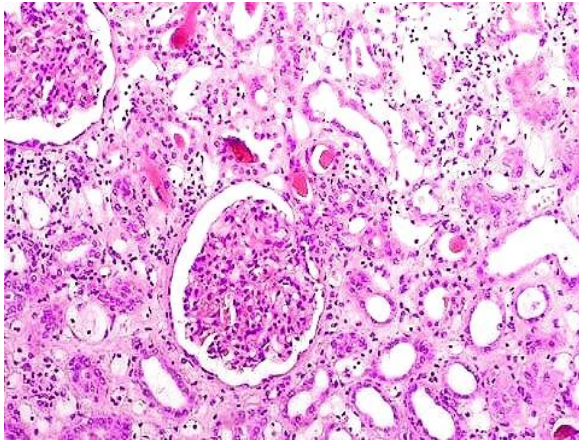

**T.S in kidney stained with Haematoxylin (nucleus/purple) and Eosin (cytoplasm/pink).**

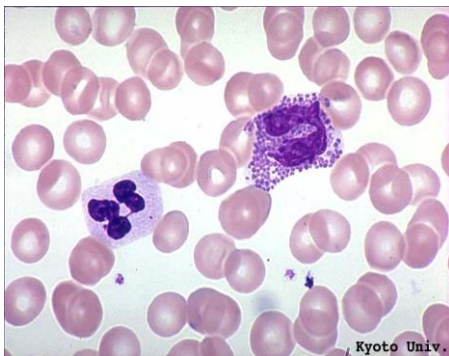

Mammalian blood smear stained with geimsa stain, nucleus is purple and cytoplasm is pink.

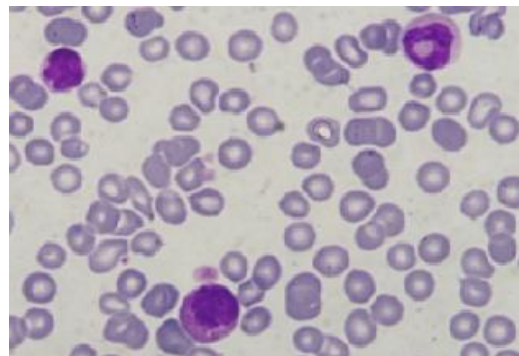

Mammalian blood smear stained with leishman's stain, nucleus is violet color and cytoplasm blue colors.

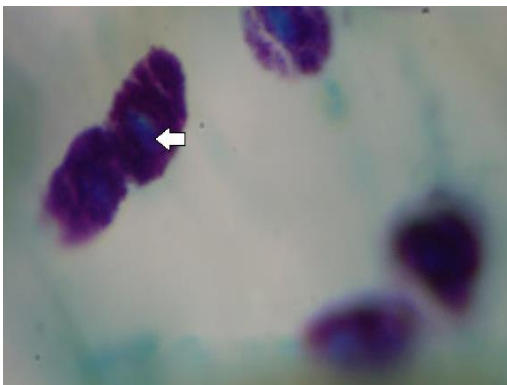

Mast Cells in mesentery (100x); toluidine blue stains the granules purple (metachromasia), and the nuclei (short arrow) are visible (blue).

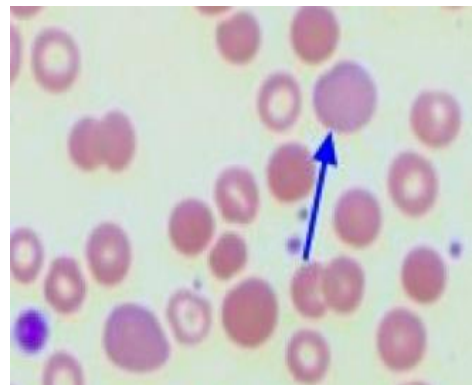

Polychromasia red blood cells

## **Electron stains**

They are substances used to stain specimens to be visible under electron microscopes, they called **negative stains**. They act by hindering the transmission of electrons (i.e. they are 'electron dense'). The electron stains are uranyl acetate (UA), lead citrate and phosphotungstic acid (PTA).

### **Uranyl acetate (4% Stock Solution):**

Uranyl acetate (1% and 2%) is a very popular and widely used stain for electron microscope. Uranyl acetate improves tissue penetration and contrast without affecting immunolabeling. It is useful as positive or negative stain for thin sections, for 1% and 2% uranyl acetate usually used.

### **Lead citrate:**

Used widely worldwide as an electron dense metal stain for ultra-thin sections, lead solutions are frequently employed after uranyl staining to produce high contrast and to also stain many cellular and tissue components.

### **Phosphotungstic acid (PTA).**

Phosphotungstic acid is electron dense, opaque for electrons. It is a common negative stain for viruses, nerves, polysaccharides, and other biological tissue materials for imaging by a transmission electron microscope. Phosphotungstic acid is used in histology as a component for staining, often together with haematoxylin as PTAH. It is used to show gliosis in the central nervous system,

tumors of skeletal muscles, and fibrin deposits in lesions. It binds to fibrin, collagen, and fibers of connective tissues, and replaces the anions of dyes from these materials, selectively discoloring them.

### **b)- Staining**

Staining is the treatment of biological specimens with dyes (stains) to color part of the structure so as to make details more clearly visible through a microscope. In a **simple staining technique**, a basic, cationic dye is flooded across a sample, adding color to the cells. Before we move on, let's define the word cationic. A **cation** is simply a positively charged ion. The molecules that make up basic dyes have a positive charge. This is important because the cell wall and cytoplasm of bacterial cells have a negative charge. The positively charged dye is attracted to the negatively charged cells, enhancing the ability of the stain to stick to and color the cells. Now, those nearly colorless cells should pop off the slide in any number of colors. Most laboratory stains are synthetic organic dyestuffs, which are absorbed by or bind to particular types of tissue. There are two types of staining:-

a- Positive staining (staining proper)

b- Negative staining

#### **a- Positive staining (staining proper)**

It is a direct binding of a dye with a tissue component (**stain stick with the specimen**) to produce contrast under light microscope. In electron microscopy, heavy metals like uranyl and lead salts are

used to bind to selective cell constituents to produce increased density to the electron beam (contrast). The staining process may involve immersing the sample (before or after fixation and mounting) in dye solution, followed by rinsing and observation.

### **b- Negative staining**

Negative staining doesn't stick with the specimen but settle around its outer boundary and forming a silhouette. It is an easy, rapid, qualitative method for examining the structure of isolated organelles and often used in diagnostic microscopy. The background is stained, leaving the actual specimen untouched, which appear light against the dark surrounding background and thus visible. In a negative staining technique, an acidic, anionic dye is mixed with a cell sample. The dye changes the color of the background, not the cells, causing the cells to stand out. This process can be considered the opposite of simple staining. An anion is a negatively charged ion; therefore an anionic dye has a negative charge. When the negatively charged dye is added to the negatively charged cells, the two repel each other, meaning they push apart.

For **bright field microscopy**, negative staining is typically performed using a black ink fluid such as nigrosin. This can be achieved by smearing the sample onto the slide and then applying **nigrosin** (a black synthetic dye- negative stain) or **India ink** (an aqueous suspension of carbon particles). After air drying, the unstained samples may be viewed in light microscope as lighter

inclusions well-contrasted against the dark environment surrounding them.

In the case of **transmission electron microscopy**, opaqueness to electrons is related to the atomic number, i.e., the number of protons. Some suitable negative stains include uranyl acetate, uranyl formate, phosphotungstic acid and osmium tetroxide. These have been chosen because they scatter electrons strongly and also adsorb to biological matter well. The structures which can be negatively stained are much smaller than those studied with the light microscope. The method is used to view viruses, bacteria, bacterial flagella, biological membrane structures and proteins or protein aggregates, which all have a low electron-scattering power. Some stains, such as osmium tetroxide and osmium ferricyanide, are very chemically active. As strong oxidants, they cross-link lipids mainly by reacting with unsaturated carbon-carbon bonds, and thereby both fix biological membranes in place in tissue samples and simultaneously stain them.

Negative staining has an advantage over the direct or positive staining methods for the study of morphology of cells. This is because of the fact that the cells do not receive vigorous physical or chemical treatments. The coloring power of acidic dye **e.g. eosin** in sodium eosinate is having negative charge; therefore, it does not combine with the **negatively charged** bacterial cell surface. On the other hand, it forms a deposit around the cell,

resulting into appearance of bacterial cell colorless against dark background.

### **Techniques of staining**

Various complex techniques are used for staining different types of tissues for light microscopes.

1- Vital staining (staining of living cells)

2- Non-vital staining

3- Other techniques of staining

A- Staining by chemical production of colored substances in tissues

B- Metallic impregnation and argentaffin reaction

### **1- Vital staining (staining of living cells)**

A stain introduced into the living organism, and taken up selectively by various tissues or cellular elements. There are two ways:-

**a) - Intravital staining**

**b) - Supravital staining**

**a)- Intravital staining:** It means staining living tissue inside the body. Injection of stain (as Trypan blue and Indian ink) into main veins of the living animal. The cells engulfed the stain then their components appear.

A method of staining living cells with special stains used in nontoxic concentrations. The dyes may be basic, such as neutral red and methylene blue (a chromophore group bonded to a cation),

or acidic, such as phenol red and cyanol (a chromophore group bonded to an anion).

Upon penetrating an animal cell, some stains may diffusely stain the cytoplasm; others are deposited in the form of granules in the region of the Golgi complex, leaving the nucleus and cytoplasm unstained.

When the cells are damaged, staining with diffuse stains is intensified, whereas granular ones lose the ability to form granules and stain the cytoplasm and nucleus diffusely. In living plant cells the stains condense in the vacuoles; in dead cells they stain the entire protoplast. These characteristics make it possible to differentiate dead and damaged cells from living ones.

**Example:-** Staining of phagocytic cells by **Trypan blue** stain.

**b)- Supravital staining:** It means immersion of the isolated (outside the body) tissues or cells in the staining solution. A stain introduced in living tissue that has been removed from the body, but before cessation of the chemical life of the cells.

**Example:-** Staining of mitochondria by **Janus green B**. Also **brilliant cresyl blue** is supravital stain used for counting reticulocyte.

## **2- Non-vital staining**

It is the coloring of dead tissue, to be clearly visible under different types of light microscopes, such as:-

**E.g. Haematoxylin (Hx)** (basic stain) uses to stain acidic structure of the cell (nucleus).

**E.g. Eosin (E)** (acidic stain) uses to stain basic structures of the cell (cytoplasm).

**E.g. Geimsa** stain (neutral stain) uses to stain both acidic and basic structures of the cell.

### **3- Other techniques of staining**

#### **A- Staining by chemical production of colored substances in tissues**

In this method of staining, colorless solutions are using in staining, where these solutions are react with the components of the tissues producing colored substances those easily recognize. The product of staining will be either stain or colored chemical substance. Such as:- **Schiff's reagent and Feulgen's method.**

**Schiff's reagent** is a solution made by reaction of basic fuchsine, a red dye, with sulfurous acid. The reagent ideally is colorless, but it may be light yellow on account of impurities in the dye. It used in staining of polysaccharides. Schiff's reagent is a solution that will combine chemically with aldehydes (an organic compound containing a formyl group) to form a bright red product. This functional group, with the structure R-CHO, consists of a carbonyl center (a carbon double bonded to oxygen) bonded to hydrogen and an R group, which is any generic alkyl or side chain.

It is use as a qualitative test for aldehydes, and characteristic a violet-red color develops. The product of staining is carmine-colored stain.



**Feulgen's method or** technique is a staining technique used to identify (staining) chromosomal material or DNA in cell specimens. It depends on acid hydrolysis of DNA, which should be stained red. The background, if counterstained, is green.

### **B- Metallic impregnation and argentaffin reaction**

They are staining patterns based upon the ability the tissues in reduction of the used solution (example silver nitrate into metallic silver) with/without external solution. Metallic silver may range in color from yellow through brown to black depending on particle size and density. In both methods, staining process produces colored substance in certain points inside the tissue.

**Metallic impregnation:** It means reduction of the used solution (silver nitrate into metallic silver) by external solution. It uses in staining of components of central nervous system. The tissue (such as nerve fibers) should be immersed in 40% silver nitrate solution. None reduced metal (silver) allowed to sediment on the aimed structures. The tissues then transferred into reduction solution (such as formalin) that reduces the metal into its metallic state, which appears as black deposit (sediment) in tissue section.

**Argentaffin reaction:** In this case the aimed part of the tissue has the ability to reduce the silver nitrate solution into metallic silver without external reduction solution. It uses to identify **neuroendocrine** cells and in staining **melanin** (it is a pigment in

the body that increased when melanin – produce cells are infected with diseases or tumor cases. Melanin is pigment produced in the pineal gland and gives human skin, hair, and eyes their color. Dark-skinned people have more melanin in their skin than light-skinned people. **Types of stains for argentaffin include:**

1. **Diazo (diazonium salts)**
2. **Fontana-Masson**
3. **Schmorl's**
4. **Autofluorescence**

**Example:-** The commonly used **Fontana-Masson** ("melanin stain") method relies upon the melanin granules to reduce ammoniacal silver nitrate into metallic silver.

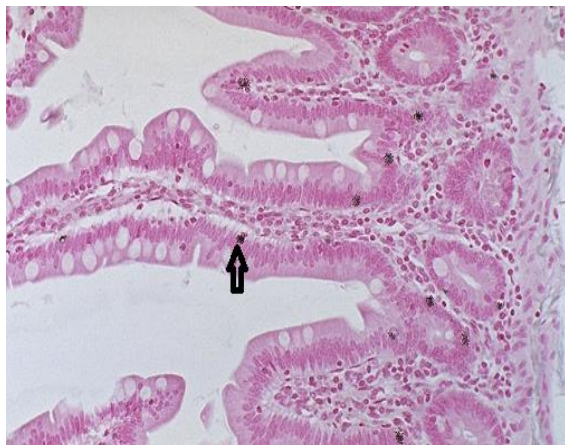

**Gastrointestinal tract enteroendocrine cells stained with Fontana-Masson argentaffin stain.**

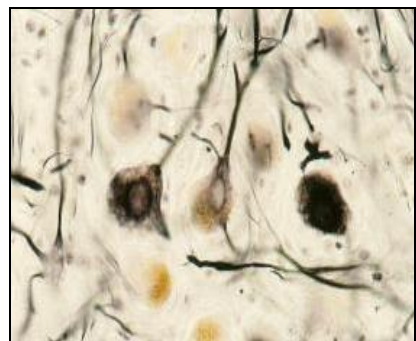

**Neurons and glial cells (autonomic ganglion, silver impregnation)**

### **The effects of $p^H$ on staining:**

Because of differences in amino acids composition proteins may have quite different properties.

By staining with an acid stain at different  $p^H$  different proteins can be stained. At low  $p^H$  (2.0-2.2) all proteins of the cell stain. In an acid medium the positively charged (basic) groups on the proteins are all available for combination with the acid (negatively charged) dye.

The proteins (histones) associated with the DNA of the chromosomes are very basic, a result of a very high concentration of lysine and arginine. These proteins are called histones. At high  $p^H$  (8.0-8.1) only the very basic proteins of the nucleus have any available basic groups ionized so as to be capable of forming a salt linkage with the dye. We are thus able to use one dye as a general protein stain, or a histone stain, by adjusting the  $p^H$  of the dye solution.

## Preparation of microscopic slides for light microscope

There are many types of microscopic slides, such as:-

**1- Smears 2- Squashes 3- whole mounts 4- Sections**

### **1- SMEARS**

Smears are prepared by smearing opaque fluid tissues such as blood as a thin layer on a slide. This layer is air-dried, fixed and stained. It may subsequently be preserved in dry form or mounted in resin.

**EXAMPLE:- Preparation blood smears of human.**

#### **1- Smear preparation:-**

- a) Clean the finger using ethyl alcohol. Get blood sample from finger puncture. After wiping off the first drop of blood, touch a clean glass microscopic slide from the end to a small drop of blood standing on the finger onto the center of the slide. Remove the slide from the finger, turn it blood side up, and place it on horizontal surface.
- b) Holding a second clean glass slide at 40° angle, touch the angled end to the midlength area of the specimen slide.
- c) Pull the angled slide back into the blood, and allow the blood to almost fill the end area of the angled slide. Quickly and steadily move the angled slide toward the opposite end of the specimen slide until the blood is used up. Or, push the slide smoothly forward to spread the smear.
- d) The result will be a thin film.

- e) Label the slide, and allow it to air dry while protected from dust for at least 10 min.

## **2- Smear fixation:-**

Smears may be fixed by drying or in alcohol or in one of the conventional fixatives. Commonly, fixing of blood smears occurs in methyl alcohol. Fixation by drying is good in the case of bacteria and erythrocytes, which do not change their shape after drying. It is dried by waving it in the air. All other smears should be fixed before they are dried. Time of fixation of blood films in methyl alcohol is about 5 minutes.

## **3- Smear staining:-**

Blood smears are stained with one of the methylene blue-eosinate mixtures as Giemsa stain. This mixture acts as a fixative (methyl alcohol) and staining materials (other component). For materials – other than blood- there is no limit to the type of staining that may be employed. If the film will be stained with Wright's stain, it does not need to be fixed. Wright's stain contains the fixative and stain in one solution. Time of staining of blood films in giemsa stain is about 45 minutes.

## **4- Smear mounting and labeling:-**

Preferably, the stained blood smears should be mounted using Canada balsam and covered by slide cover. After the

first label, the following information should be neatly printed on the label:

- a. Name of (human if needed)
- b. Fixative
- c. Stains
- e. Initials of slide-maker
- g. Date

Attach label to left end of slide. Be sure slide surface is perfectly clean before applying label.

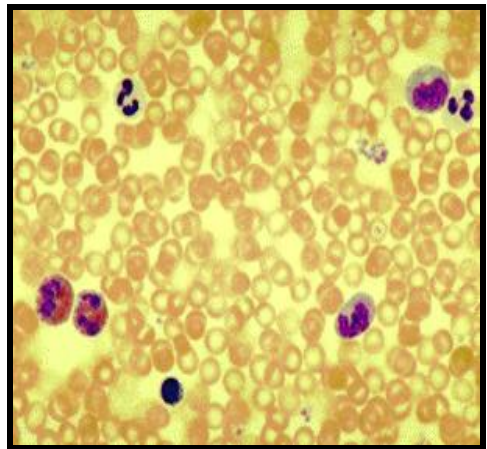
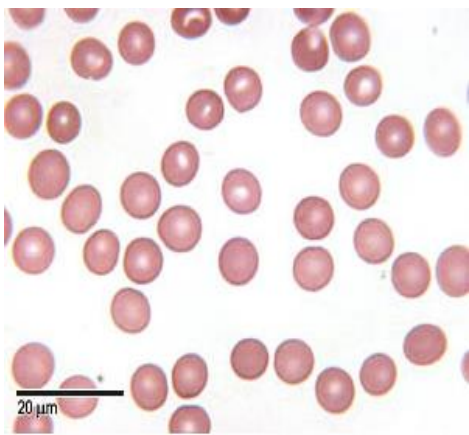
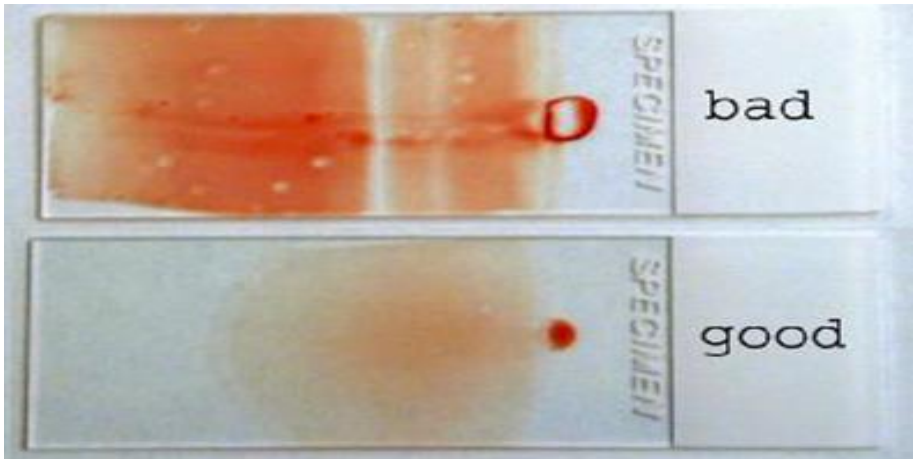
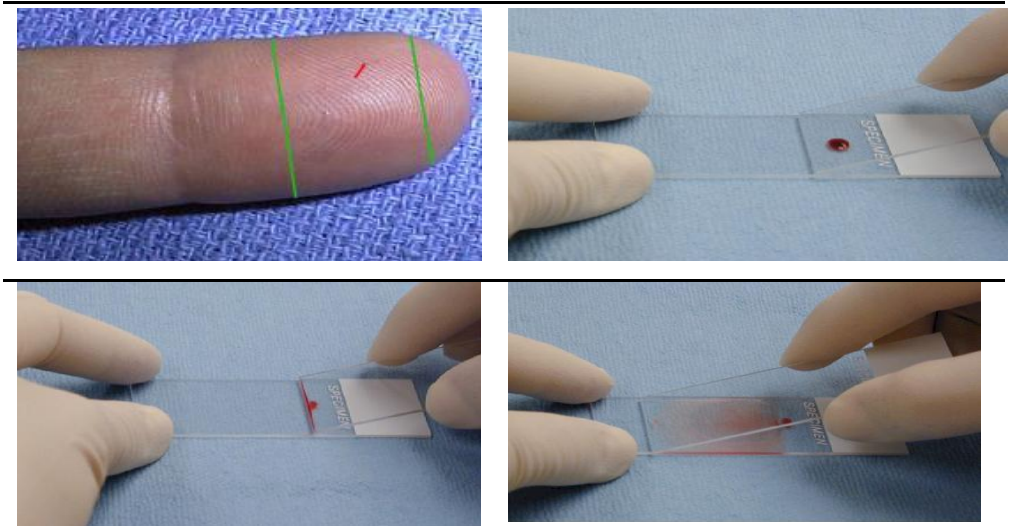

**Blood smear of human**

## **2-SQUASHES**

Squashes mean spreading the solid samples by pressure using cover-slide or slides. Such as squashes of the ovary, testis and bone marrow. This method is usually confined to the study of chromosomes. Squashing process is desired to study the contents of the cell regardless to the shape or relationships to the other components. It is necessary – in solid mass- to separate the cells from the other one in some fluid medium (physiological solution-saline solution) to obtain a thin layer of cells.

**EXAMPLE:-** Squash preparation of seminiferous tubules (**testis**)

### **1- Squash preparation:-**

- a-** Place a piece of the tissue (**testis**) on the slide.
- b-** Apply a second slide.
- c-** Push the two slides in different directions to spread the squash.

### **2- Squash fixation:-**

No need to fix the squashes, because fresh-material cells should be examined alive.

### **3- Squash staining:-**

Many basic dyes are useful, i.e. neutral red and methylene blue. In such cases the dye is dissolve in a suitable physiological solution, thus the dye acts on the cells without any change in osmotic pressure of the tissue.

### **4- Squash mounting and labeling:-**

Generally, fresh squash prepared, where mounting and labeling are not needed, because they are not permanent preparation.



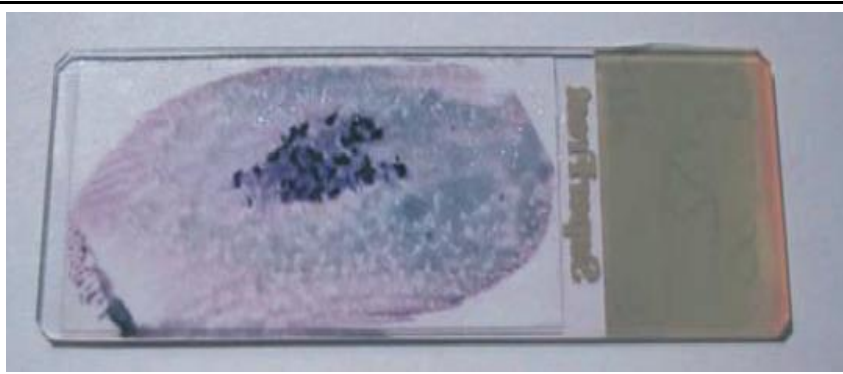

Squash of bone marrow

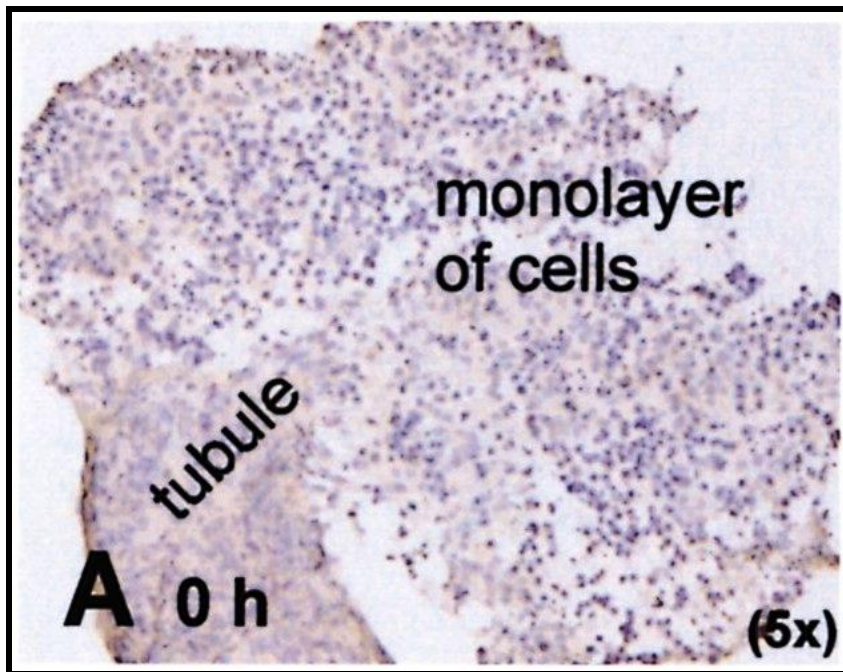

Squash of human seminiferous tubules

### **3- WHOLE MOUNTS**

It means preparation of whole or parts of the body animal to be examined easily. There are two types:-

#### **1- Dry whole mounts**

It uses with parts or whole animal is mainly dry, or could be dried, such as shells, spines, wings of insects, hairs and sections of bones and teeth. Examination depends on the transparence of the sample (transparent\transmission or dark\reflection).

#### **2- Wet whole mounts**

It uses with small parts or small body animals. Animal or its parts mount on a slide and examined by transmission light, such as samples of invertebrates (protozoa and parasitic helminthes) or larvae of vertebrates. **Wet whole mounts** may be:-

##### **A) Unstained wet whole mounts**

##### **B) Stained wet whole mounts**

#### **(a)- Unstained whole mounts:**

It will be:

- Preparations mounting in the air (sections of bones and transparent wings of insects).
- Preparations mounting in media (glycerin or glycerol jelly) soluble in water (such as eggs of parasitic helminthes or small nematodes).

- Preparations mounting in resin media, it uses for permanent preparations. Such as hairs and sections bone. Specimens could be directly mounted or need bleaching before to be more transparent.

**Example:- Preparation of unstained wet whole mount**

A wet mount is just a drop of water containing the object to be studied on a slide covered with a coverslip. Steps are

- Place a clean slide on a table.
- Place the specimen to be studied on the slide.
- Use an eyedropper to place one drop of water on the specimen
- Hold the coverslip so that one side just touches the edge of the drop of water. Let the coverslip drop.

**(b)- Stained wet whole mounts:**

It is a whole mount preparation stained with carmine, haematoxylin and some other stains.

**Example:- Preparation of a stained wet whole mount of *Fasciola*.**

**1- Whole mount preparation:-**

The whole mounts should be washed in saline solution (0.9% sodium chloride powder) several times to be freed from the tissue debris.

**2- Whole mount fixation:-**

Some whole mounts need to be flattened between two glass slides and gently pressed to flatten the specimen (in cases of trematodes and cestodes). The slides should be clamped using a rubber band

over each end of slides to maintain the pressure. Drop the slides into 10% neutral formalin fixative for about 4 hours. The fixed specimens have to be washed several times with tap water to remove the traces of formalin and to be able to free fixed worms from the slides.

### **3- Whole mount Staining:-**

**Staining** of the fixed specimens in diluted carmine stain for 20-24 hours.

**Differentiation** can be done by acid-alcohol (70% ethyl alcohol with 0.1% concentrated hydrochloric acid) with addition of one drop of acetic acid.

### **4- Whole mount dehydration and clearing:-**

**Dehydration** occurs by successive treatment with 50%, 70%, 95% ethyl alcohol and complete dehydration in absolute ethyl alcohol.

**Clearing** of the specimens carries out by passing through Clove oil or Canada balsam.

### **5- Whole mount mounting:-**

**Mounting** the stained specimen by transferring it to a clean slide using Canada balsam.

### **6- Labeling of the whole mount:-**

The following information should be neatly printed on the label:

- a. Name of organ and\or Name of animal
- b. Fixative
- c. Stains

e. Initials of slide-maker

g. Date

Attach label to left end of slide. Be sure slide surface is perfectly clean before applying label.

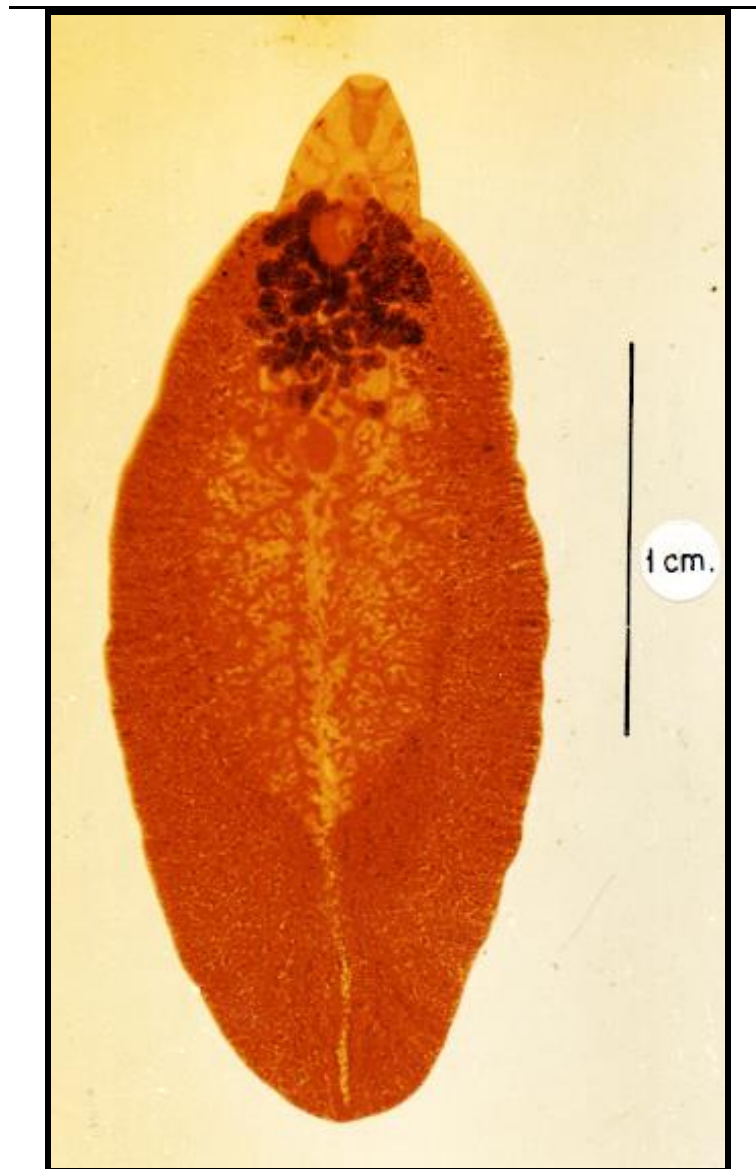

*Fasciola* sp. stained with carmine

#### **4- SECTIONS**

It means cutting a whole small animal or an organ into very thin slices (sections) to be examined using light microscope.

Organisms too large to be made into whole mounts, but too small to be studied by dissection, can be examined in the form of thin slices (sections). Most animal tissues are too soft to be cut into thin slices and most therefore first be hardened. Certain soft tissues may be hardened by freezing and cut in the same conditions.

#### **Techniques for preparing sections**

Many techniques used to prepare sections; also many steps are needed depending on the technique and the tool of examination.

#### **For the light microscope:-**

Mainly, there are three techniques for preparing sections for light microscopes:-

**A- Paraffin technique.**

**B- Celloidin technique.**

**C- Freezing technique, the frozen sections technique.**

#### **For the transmission electron microscope:-**

There is only one technique for preparing sections for electron microscopes (for TEM), which is

**D- Semithin sections technique.**

### **A- Paraffin technique:**

The tissue is infiltrated with melted paraffin to take the same consistency of paraffin (hard).

It is the most commonly used. Once the sections are prepared, they are usually stained, to help distinguish the components of the tissue. because the optical density of the different tissue components is very similar.

#### **Advantages:**

1. Gives thin sections (4-10  $\mu\text{m}$ ).
2. Could be prepared in few days i.e. not time consuming.
3. Easy to cut & stain.

#### **Disadvantages:**

Not suitable for histochemical studies as formalin & heat of the oven destroy the enzymes.

### **B- Celloidin technique**

In this technique the paraffin is replaced by celloidin. Celloidin is melted by ether & alcohol (heat is not used).

#### **Advantages:**

1. It is the most perfect as heating is not used.
2. It is used for tissues which are sensitive to heat e.g. brain & eye ball.

#### **Disadvantages:**

1. Produce thick sections.
2. Consumes a long time (8 weeks).
3. Difficult to stain.

### **C- Freezing technique.**

The frozen sections technique uses a method similar to that for semithin sections. Certain soft tissues hardened by freezing and cut in the same conditions without using chemicals. It is a rapid way to fix and mount histology sections. It is used in surgical removal of tumors. Tissues are frozen rapidly in liquid nitrogen, and then cut in a refrigerated cabinet (a cryostat) with a cold knife, then stained and observed in the microscope. This procedure is faster, and can preserve some tissue details that may be lost by the paraffin technique. Sections are 5 - 10  $\mu\text{m}$  thick.

#### **Advantages:**

1. Very rapid method.
2. Lipids in the tissues are preserved (not dissolve).
3. Suitable for histochemical study as enzymes are not destroyed.

#### **Disadvantages:**

1. Producing thick sections.
2. Difficult to cut & stain.

### **D- Semithin sections technique:**

It is sometimes hard to see detail in thick sections. To get around this, sections can be embedded in epoxy or acrylic resin, which enable thinner sections (less than 2  $\mu\text{m}$ ) to be cut. Sections are prepared for the electron microscope.



## **Steps of Paraffin technique**

It is the most common technique in student labs. In this technique, washed tissues (about 5 mm) are, fixed, and embedded in paraffin wax. This makes the tissue hard, and much easier to be cut into sections. The sections are then stained, dehydrated, mounted and examined with the light microscope. The steps are:-

- 1- Preparation of animal
- 2- Fixation
- 3- Dehydration
- 4- Clearing
- 5- Impregnation and embedding
- 6- Sectioning
- 7- Dissolving the paraffin wax and hydration
- 8- Staining and differentiation
- 9- Dehydration and clearing
- 10- Mounting, cleaning and labeling.

### **1- Preparation of animal**

The animal should be immobilized (using narcotic substance) before sectioning or before dissected out for tissues separation. The tissue must be removed immediately to avoid autolysis and washed in physiological solution. Tissue samples should not exceed 5 mm in thickness to achieve optimum fixation.

### **2- Fixation**

The fixatives destroy the enzymes that cause autolysis. The specimen is put in 10% formal saline for 24 hours for fixation

(preservation). The chemical added binds to and cross-links some proteins, and denatures other proteins through dehydration. This hardens the tissue, and inactivates enzymes that might otherwise degrade the tissue. Fixation also kills bacteria etc. It can also enhance tissue staining.

The fixative most commonly used is formalin fixatives at neutral  $p^H$ , and for light microscope (formalin concentration depending on the samples). After fixation the excess fixative must be removed by putting the pieces of tissues in running tap water.

### **3- Dehydration**

To cut sections, the tissue has to be embedded in paraffin wax, but wax is not soluble in water or alcohol. However, it is soluble in a paraffin solvent called 'xylene'. Therefore, the water in the tissue needs to be replaced with xylene. To do this, first the tissue has to be dehydrated, by gradually replacing water in the sample with alcohol. This is achieved by passing the tissue through increasing concentrations (ascending grades) of ethyl alcohol (from 70 to 100%).

### **4- Clearing (in xylol):**

Once the water has been replaced by 100% alcohol, the alcohol is replaced with xylene (a clearing agent). The tissue is placed in xylol that renders the tissue transparent. Xylol is paraffin solvent miscible with alcohol.

## **5- Impregnation and Embedding**

Impregnate (infiltrate) the tissue in melted paraffin wax in the oven (at 60°C). The melted wax fills the spaces that used to have water in them. After cooling, the tissue hardens, and can be used to cut slices (sectioned). Embed in hard paraffin to obtain a paraffin block.

## **6- Sectioning**

Sections are cut by rotatory microtome at (4-8  $\mu\text{m}$ ), as follow:-

Trim paraffin blocks to an optimal cutting surface including the sample with a small paraffin frame.

Cut 3-10  $\mu\text{m}$  slices (5  $\mu\text{m}$  is commonly used); use a brush to draw the section onto the knife holder.

Place paraffin ribbon or slice in 40-45°C water bath with a 2nd wet brush (it will expand and wrinkles will vanish).

The paraffin sections are picked on glass slides and a brush to position the section).

Dry sections at 37°C.

## **7- Dissolving the paraffin wax and hydration**

Rehydrate for subsequent methods (paraffin to water):-

Deparaffinise, two changes of xylene, 3-10 min each (3+ changes for sections  $>25\mu\text{m}$ ).

Rehydrate, two changes of 100% ethanol, 3 min each.

Rehydrate, two changes of 95% ethanol, 3 min each.

Rinse in distilled water.

## **8- Staining and differentiation**

### **Staining**

A couple drops of stain in a small volume of 50-70% ethanol should work in a few hours to overnight. Stains, such as rose Bengal, alum carmine, congo red and many other may give good results.

Double staining or mixing stains sometimes helps as different structures (or different species are differentially stained.

### **Differentiation**

Overly stained specimens may be difficult to see through, such slides need differentiation.

Wash the excess of the stain in distilled water.

Transfer the slides to acidified 70% alcohol till the proper density of color is attained.

Rinse the slides (2 minutes) in alkaline water (tap water) to neutralises any acid present.

## **9- Dehydration and clearing**

### **Dehydration**

The water in the tissue needs to be replaced with xylene. To do this, first the tissue has to be dehydrated, by gradually replacing water in the sample with alcohol. This is achieved by passing the tissue through increasing concentrations of ethyl alcohol (from 30 to 100%).

## **Clearing**

Once the water has been replaced by 100% alcohol, the alcohol is replaced with xylene (a clearing agent), which is miscible with alcohol.

## **10- Mounting, cleaning and labeling**

### **Mounting**

After staining, it is then mounted on the microscope slide in mounting medium dissolved in xylene. A coverslip is placed on top, to protect the sample. Evaporation of xylene around the edges of the coverslip, dries the mounting medium and bonds the cover lips firmly to the slide.

The coverslip should be dropped over the specimens from a low angle with one edge entirely in contact with the resin patch.

It can be moved a little after this drop if necessary and additional resin can be added to completely fill the area under the coverslip.

The slides should be kept flat and undisturbed in a dust free area. They may take weeks to completely dry, but this is greatly accelerated in a small oven at very low heat (40°C) to dry and harden the canada balsam. Evaporation of xylene around the edges of the coverslip, dries the mounting medium and bonds the coverlips firmly to the slide.

## **Cleaning and labeling slides**

There is no point in going to all the trouble of making a good slide unless one is prepared to clean and label it properly. Mountant must be dry and hard before cleaning.

- 1- Clean any excess mountant away from the edge of the coverslip with a single edge razor blade. Mountant must be dry and hard before cleaning.
- 2- Wipe slide off with acidified 95% alcohol. This will remove any remaining mountant and smears of stain.
- 3- Dip slide in a warm detergent solution and polish dry with a cheese cloth.
- 4- The following information should be neatly printed on the label in India ink (use rapidograph or similar fine pen):
  - a. Name of organ
  - b. Name of animal
  - c. Fixative
  - d. Stains
  - e. Initials of slide-maker
  - f. Thickness of section
  - g. Date
5. Attach label to the –clean- left end of slide. A permanent label should be glued to the slide as soon as the slide is cured.

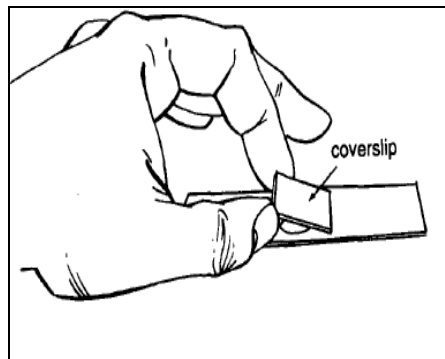
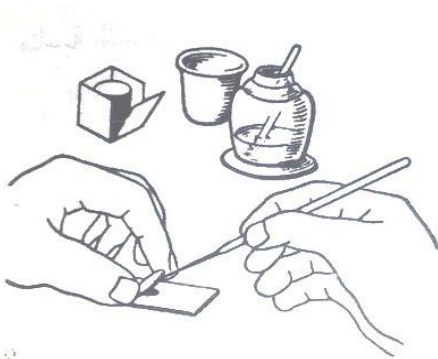
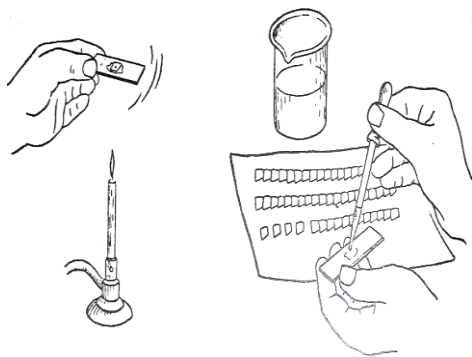
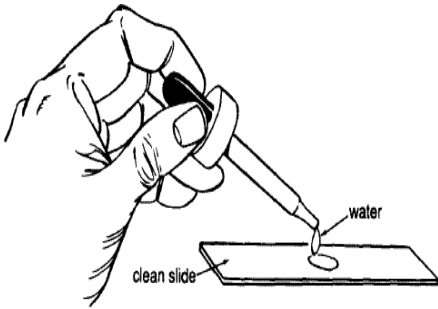
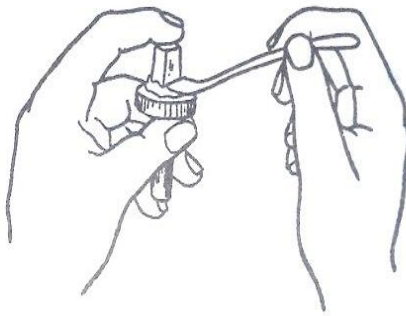
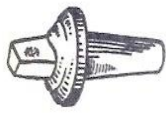

## **Infiltration and Embedding**

**INFILTRATION** is a replacement of clearing solution (**impregnation of sample**) by wax, gelatin, celloidin and wax, and cellulose nitrate. It is a replacement of clearing solution by one of the mentioned materials.

**EMBEDDING** means a suitable media containing sample.

There are many ways of infiltration and embedding:-

- 1- Infiltration and embedding in paraffin wax
- 2- Infiltration and embedding in gelatin
- 3- Infiltration and embedding in celloidin paraffin wax
- 4- Infiltration and embedding in cellulose nitrate

### **1- Infiltration and embedding in paraffin wax**

**Paraffin wax** is mostly found as a white, odorless, tasteless, waxy solid, with a typical melting point between about 46 and 68 °C. For infiltration, sample should be placed in a mixture of paraffin wax and clearing solution in oven (45-60 C). Time depends on type and volume of the sample.

For embedding, the sample should be placed in suitable container containing liquid paraffin wax and has to be left until cooled.

### **2- Infiltration and embedding in gelatin**

**Gelatin** is a translucent, colorless, brittle (when dry), flavorless solid substance, derived from collagen obtained from various animal by-products. It is used when sample affected by high heat,



soluble lipids or soft samples, such as testis. Sectioning will be using cryostat (ice-microtome).

- Fixation and washing should be carried as usual.
- The sample placed in 10 % hot celloidin for infiltration (12 hours).
- The sample transferred to cooled place (4, 8, and 12 hours).
- Cutting of blocks containing the samples.
- The blocks transferred into 10% formalin for hardening (few hours).

### **3- Infiltration and embedding in celloidin paraffin wax**

Celloidin is a semisolid solution of pyroxylin in ether and alcohol. Used to embed specimens (soft and solid) for microscopy before they are sectioned and placed on slides. Fixation, washing and dehydration should be carried as usual.

The sample placed in celloidin dissolved in methyl benzoate for three times, each for 24 hours.

The sample transferred into three changes of pure benzene (4, 8, and 12 hours).

The sample transferred into melted paraffin wax and benzene (ratio 1:1) for one hour in the oven.

The sample transferred into two changes of melted paraffin wax. Time ranged between 0.5 – 6 hours depending on type and volume of the sample.

Embedding occurs in paraffin wax as usual.

#### **4- Infiltration and embedding in cellulose nitrate**

Cellulose nitrate is a mixture of celloidin and low viscosity nitrocellulose. It uses to ovoid disadvantages or defects of embedding the sample in paraffin wax. Fixation, washing and dehydration should be carried as usual.

- The sample placed in equal quantities of ether and alcohol for 24 hours.
- The sample transferred into 2% celloidin for 5-7 days.
- The sample transferred into 4% celloidin for 5-7 days.
- The sample transferred into 8% celloidin for 3-4 days.
- Embedding occurs in 8% celloidin.
- Block of celloidin placed in well closed small bottle containing ether.

#### **Advantages**

- a-** There is no heat treatment to ovoid shrinkage of the tissue.
- b-** It gives a good result in sectioning of dense tissue such as bone (due to hardening and plasticity of the medium). **d-** It gives a good result in sectioning of organ (such as eye) composed of many tissues those different in hardening degree.
- c-** Thick sections are better than those of wax sections.

#### **Disadvantages**

- a-** The slowness, it required several weeks.
- b-** Restriction of the thickness of the section, not allowed cutting thinner than 10 um.

- c-** Cutting is in separate sections (not ribbon), so it is difficult to get series of successive sections.
- d-** The high flammability of the embedding medium.
- e-** Space consuming due to store of blocks in jars of alcohol.

### **Characteristics of a good slide:**

1. The tissue is not cracked or distorted; there is neither excessive shrinkage nor swelling.
2. If an organ, it is cut in a definite direction - cross, longitudinal, frontal median, etc.
3. Sections should be flat and complete, without knife marks.
4. The sections should be well arranged on the slide and should not be close to the edge of the coverslip.
5. Details are to be well shown, with sufficient contrast between the nuclear and cytoplasmic stains. Chromatin granules are visible in the nuclei.
6. The background is to be unstained. Muddiness may be due to excess albumin, a staining of the albumin, or formation of stain precipitate.
7. The edges of the coverslip are to be parallel with those of the slide, with no excess mountant leaking out. The layer of mountant should be thin, yet must completely fill the space between the coverslip and the slide.
8. The slide should be neatly labeled on the left.

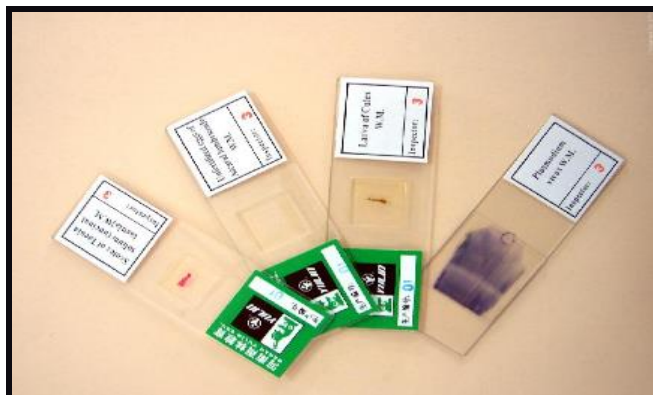

## Preparation of a specimen for electron microscope

The traditional stains (dyes) cannot be used in electron microscopy as used in light microscopy. EM uses electron dense heavy metals to impart the contrast to specimens, such as lead, osmium, silver, and gold.

Materials to be viewed under an electron microscope require special techniques. The technique required varies depending on the specimen and the analysis required:

**Chemical fixation:** For biological specimens, glutaraldehyde is the suitable fixative.

**Negative stain:** Suspensions containing nanoparticles or fine biological material (such as viruses and bacteria) are briefly mixed with a dilute solution of an electron-opaque solution such as uranyl acetate (or formate), or phosphotungstic acid. This mixture is applied to a suitably coated EM grid, blotted, and then allowed to dry. Viewing of this preparation in the EM (TEM) should be carried out without delay for best results.

**Cryofixation:** Freezing a specimen so rapidly, in liquid ethane, and maintained at liquid nitrogen or even liquid helium temperatures, so that the water forms vitreous (non-crystalline) ice. This preserves the specimen in a snapshot of its solution state. An entire field called cryo-electron microscopy has branched from this technique.

**Dehydration:** It is replacement of water with organic solvents such as ethanol or acetone, followed by critical point drying or infiltration with embedding resins. Also freeze drying.

**Embedding:** For observation biological specimens in the EM (TEM), they should be embedded so it can be sectioned ready for viewing. To do this the tissue is passed through a 'transition solvent' such as Propylene oxide (epoxypropane) or acetone and then infiltrated with an epoxy resin such as Araldite, Epon, or Durcupan; tissues may also be embedded directly in water-miscible acrylic resin. After the resin has been polymerized (hardened) the sample is thin sectioned (ultrathin sections) and stained.

After embedding in resin, the specimen is usually ground and polished to a mirror-like finish using ultra-fine abrasives. The polishing process must be performed carefully to minimize scratches and other polishing artifacts that reduce image quality. The specimen is then ready for viewing.

**Metal shadowing:** Metal (e.g. platinum) is evaporated from an overhead electrode and applied to the surface of a biological sample at an angle. The surface topography results in variations in the thickness of the metal that is seen as variations in brightness and contrast in the electron microscope image.

**Replication:** A surface shadowed with metal (e.g. platinum, or a mixture of carbon and platinum) at an angle is coated with pure carbon evaporated from carbon electrodes at right angles to the surface. This is followed by removal of the specimen material (e.g. in an acid bath, using enzymes or by mechanical separation) to produce a surface replica that records the surface ultrastructure and can be examined using electron microscopy.

**Sectioning:** Produces thin slices of specimen, semitransparent to electrons. These can be cut on an ultramicrotome with a diamond knife to produce ultra-thin slices about 60–90 nm thick. Disposable glass knives are also used because they can be made in the lab and are much cheaper.

**Staining:** Since many biological materials are nearly "transparent" to electrons (weak phase objects), so, heavy metals such as lead, uranium or tungsten are used to scatter imaging electrons and thus give contrast between different structures. In biology, specimens can be stained "en bloc" before embedding and also later after sectioning. Typically thin sections are stained for several minutes with an aqueous or alcoholic solution of uranyl acetate followed by aqueous lead citrate.

**Freeze-fracture or freeze-etch:** A preparation method particularly useful for examining lipid membranes and their incorporated proteins in "face on" view. The fresh tissue or

cell suspension is frozen rapidly (cryofixation), then fractured by breaking or by using a microtome while maintained at liquid nitrogen temperature. The cold fractured surface (sometimes "etched" by increasing the temperature to about  $-100\text{ }^{\circ}\text{C}$  for several minutes to let some ice sublime) is then shadowed with evaporated platinum or gold at an average angle of  $45^{\circ}$  in a high vacuum evaporator. A second coat of carbon, evaporated perpendicular to the average surface plane is often performed to improve stability of the replica coating. The specimen is returned to room temperature and pressure, and then the extremely fragile "pre-shadowed" metal replica of the fracture surface is released from the underlying biological material by careful chemical digestion with acids, hypochlorite solution or SDS (Sodium dodecyl sulfate) detergent. The still-floating replica is thoroughly washed free from residual chemicals, carefully fished up on fine grids, dried then viewed in the EM (TEM).

**Ion beam milling:** It is for thin samples until they are transparent to electrons by firing ions (typically argon) at the surface from an angle and sputtering material from the surface. A subclass of this is focused ion beam milling, where gallium ions are used to produce an electron transparent membrane in a specific region of the sample, for example through a device within a microprocessor. Ion beam milling may also



be used for cross-section polishing prior to SEM analysis of materials that are difficult to prepare using mechanical polishing.

**Conductive coating:** Ultrathin coatings of electrically conducting material deposited either by high vacuum evaporation or by low vacuum sputter coating of the sample. This is done to prevent the accumulation of static electric fields at the specimen due to the electron irradiation required during imaging. The coating materials include gold, gold/palladium, platinum, tungsten, graphite, etc.

**Earthing (grounding electricity):** To avoid electrical charge accumulation on a conductive coated sample, it is usually electrically connected to the metal sample holder. Often an electrically conductive adhesive is used for this purpose.

## **Sample preparation for TEM**

For study by transmission electron microscopy, good preparation of samples is vital in order to achieve high quality, reproducible, and artifact-free results.

Samples most frequently are mounted onto a very thin film of carbon or plastic; this support film is held upon a metallic grid. Tissues, organs, and industrial products all must be prepared by slicing, thinning, or polishing into a thin enough state to permit the electron beam to penetrate through the specimen. In biology, specimens are chemically (i.e., buffered cross-linkers) or physically (i.e., very rapid freezing) fixed (with glutaraldehyde and then with osmium tetroxide).

The sections are dehydrated and embedded in plastic (epoxy resin), and finally are sliced into ultrathin sections with the help of diamond or glass razor of ultra-microtome. The sections are ultrathin about 50-100 nm thick.

These sections are placed on a copper grid and stained by heavy metal solutions (electron dense materials) like lead acetate, uranylacetate, palladium vapours, phosphotungstate, in order to increase the image contrast. The coating with electron dense material enables the specimen to withstand electric bombardment. Now the sections can be viewed in the TEM.

Electron microscope immunocytochemistry with specific antibodies is used to locate various protein components in ultrathin sections. Rapid freezing is used to prepare

macromolecules and cells for electron cryo-microscopy; the frozen-hydrated unstained specimens are kept at liquid nitrogen or liquid helium temperature inside the electron microscope, thereby maintaining their native structure.

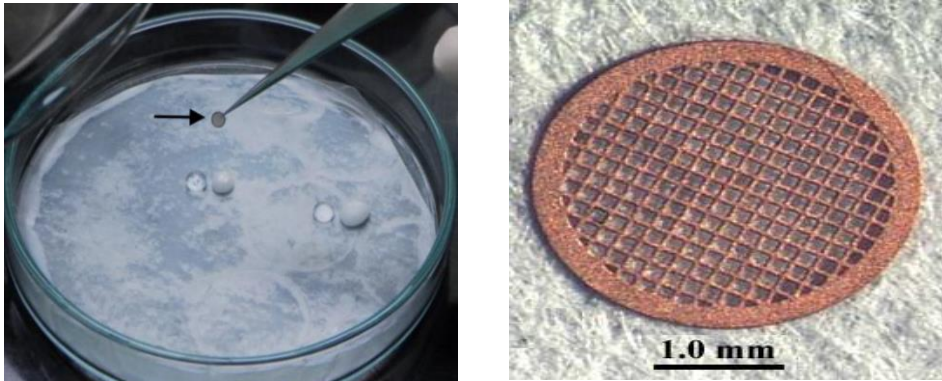

**A grid of transmission electron microscope**

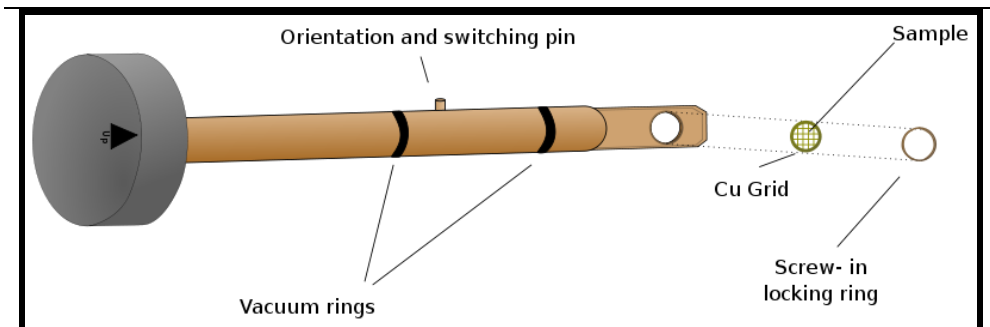

Single tilt sample holder for a TEM. Tilting is provided by rotation around the axis of the holder, which is performed by rotating the entire goniometer into which the sample is placed.

## **Sample preparation for SEM**

A specimen is normally required to be completely dry, since the specimen chamber is at high vacuum. Hard, dry materials such as wood, bone, feathers, dried insects, or shells can be examined with little further treatment, but living cells and tissues and whole, soft-bodied organisms usually require chemical fixation to preserve and stabilize their structure.

The specimen is first **fixed** by incubation in a solution of a buffered chemical fixative, such as glutaraldehyde, sometimes in combination with formaldehyde and other fixatives, and optionally followed by postfixation with osmium tetroxide.

The fixed tissue is then dehydrated. Because air-drying causes collapse and shrinkage, this is commonly achieved by replacement of water in the cells with organic solvents such as ethanol or acetone, and replacement of these solvents in turn with a transitional fluid such as liquid carbon dioxide by critical point drying. The carbon dioxide is finally removed while in a supercritical state, so that no gas–liquid interface is present within the sample during drying.

The dry specimen is usually mounted on a specimen stub using an adhesive such as epoxy resin or electrically conductive double-sided adhesive tape, and sputter-coated with a thin film of heavy metal, such as gold or gold/palladium alloy

by evaporation in a vacuum provides a reflecting surface of electrons, before examination in the SEM.

The surface of the specimen when scanned by electron beam release secondary electrons that form a three-dimensional image of the specimen on a television screen. Holes and fissures appear dark, and knobs and ridges appear light. Complete scanning from top to bottom usually takes only a few second. Now the sections can be viewed in the **SEM**.

If the SEM is equipped with a cold stage for cryo microscopy, cryofixation may be used and low-temperature scanning electron microscopy performed on the cryogenically fixed specimens. Cryo-fixed specimens may be cryo-fractured under vacuum in a special apparatus to reveal internal structure, sputter-coated, and transferred onto the SEM cryo-stage while still frozen. Low-temperature scanning electron microscopy is also applicable to the imaging of temperature-sensitive materials such as ice and fats.

Freeze-fracturing, freeze-etch or freeze-and-break is a preparation method particularly useful for examining lipid membranes and their incorporated proteins in "face on" view. The preparation method reveals the proteins embedded in the lipid bilayer.

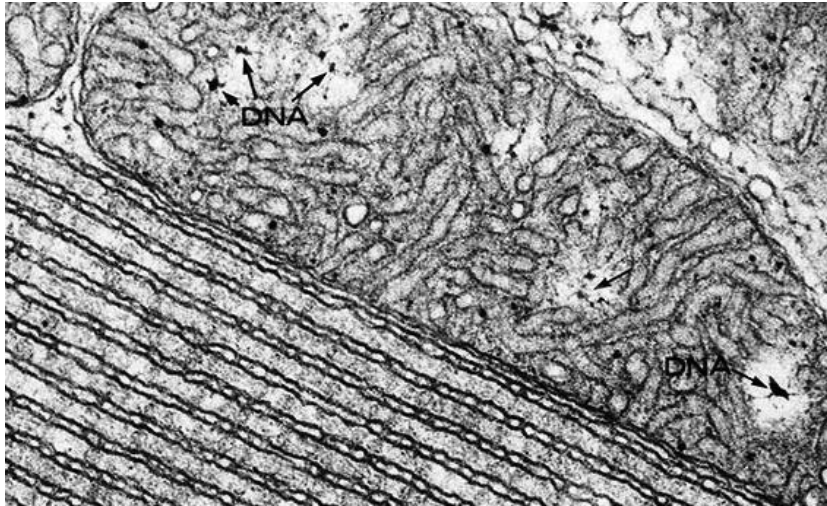

Endoplasmic reticulum and mitochondrion- TEM



Sputter-coated ant specimen (*Aulacopone relictica*) for SEM examination).

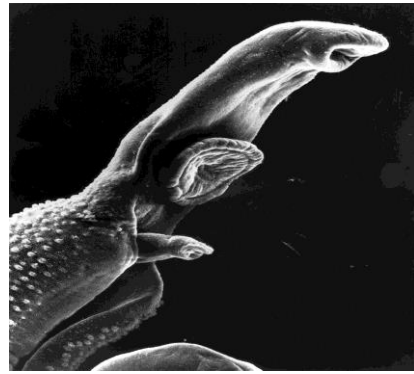

SEM of *Schistosoma*

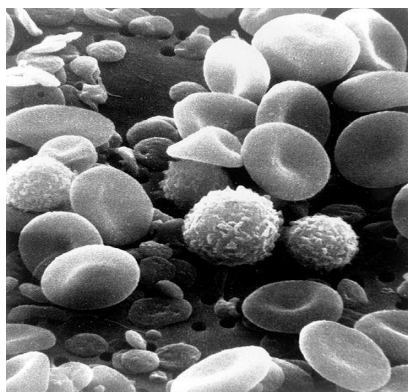

Blood smear of human, SEM

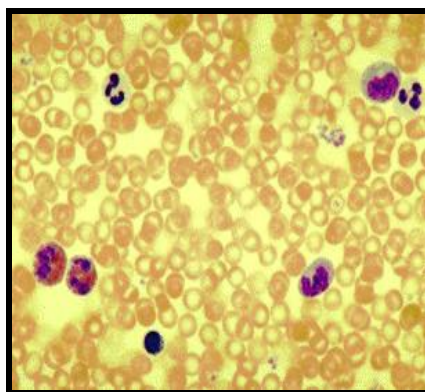

Blood smear of human, LM

## REFERENCES\ SUGGESTED READINGS

- 1- البنهاوى، محمود احمد و الجنزورى، منير على (1989): التقنية المجهرية، الطبعة الاولى- دار المعارف. مصر
- 2- Baker, J. R. (1958): Principles of biological microtechnique. John Willey & sons Inc. London, New York.
- 3- Bancroft JD, Gamble M (2002) Theory and Practice of Histological Techniques. 5th ed. London: Churchill-Livingstone.
- 4- Drury, R. A. B. and Wallington, E. A. (1980): Carleton's Histological Technique. Fourth Edition, Oxford University Press.
- 5- Kiernan JA (2008) Histological and Histochemical Methods. Theory and Practice. Bloxham, UK: Scion.

## PAST YEARS EXAMS



Final Exam

First Semester - University Year 2017\2018

Exam's title:- Microtechnique (Code-303Z)



Faculty of Science  
Zoology Department  
3<sup>rd</sup> year, Zoology

Time allowed:- 3 Hours (Shared)  
Date :- 3 January 2018  
Students No. :- 9

I advise you to not spend more than 75 minutes in answering and revision of the following questions. Total 3 questions, 90 Points

**1- Complete the missed space (5 points for each) 20 Points**

- A- ..... is an instrument or cutting machine uses in sectioning of embedded specimens.
- B- ..... is stain that makes cells or structures more visible, when not completely visible with the principal stain.
- C- .....stains acidic structures (basophilic substance) in the tissue.
- D- Dissociating is an act of ..... a complex object into parts.

**2- Write briefly about the following:- 40 Points**

- A- Negative staining (10 Points)
- B- The aim of fixation (10 Points)
- C- The narcotic substance (10 Points)
- D- Advantages and limitations of dark field microscope (10 Points)

**3- Write on:- 30 Points**

- A- Metallic impregnation. (15 points)
- B- General principles of electron microscope (EM). (15 points)

**WITH MY BEST WISHES**

**Dr. Abdel-Nasser A. Hussein**





## Final Exam

First Semester - University Year 2018\2019

Exam's title:- Microtechnique (Code-303Z)



Faculty of Science  
Zoology Department  
3<sup>rd</sup> year, Zoology

Time allowed:- 3 Hours (Shared)  
Date :-21 January 2019  
Students No. :- 7

I advise you to not spend more than 75 minutes in answering and revision of the following questions. Total 3 questions, 90 Points

**1- Choose the correct answer (5 points for each) 25 Points**

1- An example of neutral stain is.

- (a)- Eosin (b)- Geimsa (c)- Haematoxylin (d)- Carmine (Cochineal)

2- A tool uses for examination of the specimen during and after preparation is.

- (a)- Microscope (b)- P<sup>H</sup> meter (c)- Microtome (d)- Hot-plate

3- Synthetic dyes are consist of

- (a)- Chromophores (b)- Chromogens (c)- Auxochromes (d)- All of these

4- Spread out the soft tissues elements (such as bone marrow) into very thin layer, is called

- (a)- Sectioning (b)- Squashing (c)- Smearing (d)- Dissociating

5- Narcotization is important in separation of material for routine studies, but it is not preferable in studies as,

- (a)- Histochemistry (b)- Cytology (c)- Delicate cell organelles (d)- All of these

**2- Write briefly about the following):- 20 Points**

A- The aim of fixation (Functions of the fixative) (10 Points)

B- Metallic impregnation as a way of staining (10 Points)

**3- Write on:- 30 Points**

1- General disadvantages of Electron Microscopes (15 points)

2- Vital staining (staining of living cells) (15 points)

**WITH MY BEST WISHES**

**Dr. Abdel-Nasser Ahmed Hussein**