



# Analytical and Inorganic Chemistry

كيمياء تحليلية وغير عضوية

Course Code: 452Ch

For

4<sup>th</sup> Year Students

(Chem. /Botany, Chem. /Zoology, Chem. /Entomology,  
Chem. /Microbiology and Chem. /Geology groups)



# Part 1

# Instrumental Chemical Analysis

## INDEX

<b>1</b>	<b>INTRODUCTION</b>	<b>5</b>
<b>2</b>	<b>CLASSIFICATION OF THE ANALYTICAL TECHNIQUES</b>	<b>6</b>
<b>3</b>	<b>ANALYSIS THROUGH SPECTROSCOPY</b>	
<b>3.1</b>	<b>Processes in Spectroscopy</b>	<b>7</b>
<b>3.1.1</b>	<b>Atomic Level</b>	
3.1.1a	Atomic Absorption Spectroscopy ( <b>AAS</b> )	<b>8</b>
3.1.1b	Atomic Emission Spectroscopy ( <b>AES</b> )	<b>8</b>
3.1.1c	Plasma Emission Spectroscopy	<b>9</b>
3.1.1d	Fluorometry : Atomic Fluorescence	<b>10</b>
<b>3.1.2</b>	<b>Molecular Level</b>	
3.1.2a	Ultraviolet - Visible Spectroscopy ( <b>UV/Vis</b> )	<b>10</b>
3.1.2b	Fluorometry : Molecular Fluorescence	<b>11</b>
3.1.2c	Fourier Transform Infrared Spectroscopy ( <b>FT-IR</b> )	<b>12</b>
3.1.2d	Fourier Transform Raman Spectroscopy ( <b>FT-RAMAN</b> )	<b>13</b>
3.1.2e	Microwave Spectroscopy	<b>13</b>
3.1.2f	Nuclear Magnetic Resonance Spectroscopy ( <b>NMR</b> )	<b>14</b>
3.1.2g	Electron Spin Resonance Spectroscopy ( <b>ESR</b> )	<b>14</b>
<b>4</b>	<b>ANALYSIS THROUGH CHROMATOGRAPHY</b>	
<b>4.1</b>	<b>LIQUID CHROMATOGRAPHY (LC/HPLC)</b>	<b>15</b>
4.1.1	Adsorption Chromatography	<b>16</b>
4.1.2	Partition Chromatography	<b>16</b>
4.1.3	Ion-Exchange Chromatography	<b>16</b>
4.1.4	Size Exclusion Chromatography	<b>16</b>
<b>4.2</b>	<b>GAS CHROMATOGRAPHY (GC)</b>	<b>17</b>
<b>5</b>	<b>ANALYSIS THROUGH THERMAL ENERGY</b>	
<b>5.1</b>	<b>THERMAL ANALYSIS</b>	<b>20</b>
5.1.1	Thermogravimetric Analysis ( <b>TGA</b> )	<b>20</b>
5.1.2	Thermomechanical Analysis ( <b>TMA</b> )	<b>20</b>
5.1.3	Differential Thermal Analysis ( <b>DTA</b> )	<b>20</b>
5.1.4	Differential Scanning Colorimetry ( <b>DSC</b> )	<b>21</b>
<b>6</b>	<b>ANALYSIS THROUGH X-RAY TECHNIQUES</b>	
6.1	Generation of X-Rays	<b>21</b>
6.2	X-Ray Fluorescence Spectrometry ( <b>XFS</b> )	<b>22</b>
6.3	X-Ray Photo-emission Spectrometry ( <b>XPS</b> )	<b>23</b>
6.4	X-Ray Diffractometry ( <b>XRD</b> )	<b>24</b>

<b>7</b>	<b>ANALYSIS THROUGH MICROSCOPY</b>	
7.1	Scanning Electron Microscopy ( <b>SEM</b> )	<b>25</b>
7.2	Transmission Electron Microscopy ( <b>TEM</b> )	<b>26</b>
7.3	Scanning Probe Microscopy ( <b>SPM</b> )	<b>27</b>
<b>8</b>	<b>ANALYSIS THROUGH ELECTRO-CHEMICAL TECHNIQUES</b>	
8.1	Polarography	<b>29</b>
8.2	Electrophoresis	<b>29</b>
<b>9</b>	<b>ANALYSIS THROUGH MISCELLANEOUS TECHNIQUES</b>	
9.1	Total Organic Carbon Analyzer ( <b>TOC</b> )	<b>31</b>
9.2	Elemental Analyzer ( <b>CHN/S Analyzer</b> )	<b>31</b>
9.3	Polarimetry	<b>32</b>
9.4	UV/Visible Spectropolarimetry	<b>33</b>
9.5	Vibrational Circular/Linear Dichroism ( <b>VCD/VLD</b> )	<b>34</b>
9.6	Mass Spectrometry ( <b>MS</b> )	<b>34</b>
9.7	Laser Light Scattering System (Particle Sizing and Analysis)	<b>35</b>
<b>10</b>	<b>SUMMARY</b>	<b>37</b>
<b>11</b>	<b>REFERENCE</b>	<b>39</b>

## 1. INTRODUCTION

The need of the sophisticated analytical instruments and determinations using them is almost a routine process for the modern chemical laboratories. It has been a vast expanding area of knowledge as the instrument and computer manufacturers are producing analytical machines, which are in ever-increase of power and scope. Further, all the manual techniques in the line of the analytical studies had steadily been transferred to the instrumental techniques. Basically, chemical analysis can be divided into three broad categories as given below, which are almost invariably applied to major areas such as Fundamental Research, Product Development, Product Quality Control, Monitoring & Control of Pollutants, Medical & Clinical Studies, etc:

***QUALITATIVE ANALYSIS:***

Chemical analysis which just identifies one or more species present in a sample

***QUANTITATIVE ANALYSIS:***

Chemical analysis which finds out the total amount of the particular species present in a sample

***STRUCTURAL ANALYSIS:***

Chemical analysis which helps in finding the spatial arrangement of atoms in a molecule and the presence or position of certain organic functional groups in a given compound

In addition, '*Surface Analysis*', plays an important role in material studies to obtain surface related physical properties such as topography, depth profiling, orientation of molecules, etc.

Chemical analysis has some basic steps like, choice of method, sampling, preliminary sample treatment, separations, final measurement and assessment of results. It is with the first step viz. choice of method, care should be exercised to select the proper instrument to carry out fruitful analysis. A wrong selection at this point will lead to a meaningless analysis. Selection of the instrument is such important criteria!

In order to compete with this type of situation some basic knowledge of instruments and analytical techniques are required. This may give the person the ability, with some confident, to choose and operate a varied range of instruments which would be much required at the advanced research laboratories. The following pages will give an insight into the theory, principles and applications of various analytical instruments.

## **2. CLASSIFICATION OF THE ANALYTICAL TECHNIQUES**

In a broad sense the techniques for the chemical analysis can be classified as follows. Though this classification doesn't include few other techniques like radiochemical analyses, bioanalytical methods and some of the physical methods, it is more than sufficient to start with, since it covers almost all our Departmental analytical equipment under common pool:

### **ANALYSIS THROUGH SPECTROSCOPY**

### **ANALYSIS THROUGH CHROMATOGRAPHY**

### **ANALYSIS THROUGH THERMAL ENERGY**

### **ANALYSIS THROUGH X-RAY TECHNIQUES**

### **ANALYSIS THROUGH MICROSCOPY**

### **ANALYSIS THROUGH ELECTROCHEMICAL TECHNIQUES**

### **ANALYSIS THROUGH MISCELLANEOUS TECHNIQUES**

This classification is based on the interactions of molecules with various forms of energy like electro-magnetic radiation, heat (thermal energy) and with matters like electrons. Each technique has specific principle, mode of operation, advantages and disadvantages.

### 3. ANALYSIS THROUGH SPECTROSCOPY

#### 3.1 Processes in Spectroscopy

The interaction of the light (electro-magnetic radiation) with a substance and the subsequent energy transfer ends with three main processes namely:

##### **Absorption:**

The process by which the energy of the light (in the form of photons) is transferred to the atom or molecule raising them from the ground state to an excited state

##### **Fluorescence:**

The absorbed energy is rapidly lost to the surroundings by collisions within the system and relax back to the ground state. Sometimes the energy is not lost in this way but is re-emitted a few milli seconds later, which is referred as fluorescence

##### **Emission:**

If the substances (atoms or molecules) are heated to high temperatures (in a flame or in an electric discharge) the electrons are excited to higher energy levels. Later, they relax to the ground state with the emission of radiation, the magnitude of which is more or less equivalent to absorbed energy

Most of the analytical techniques are based on the light interactions with the substances and utilise any of the above three associated processes. Substances interact with light differently at various wavelengths and hence different types of analysis & instruments. The entire spectrum of light can be represented as below. Since, light has both electrical and magnetic components, this representation is referred as an **‘Electro-Magnetic Spectrum’**:

**Fig: 1**

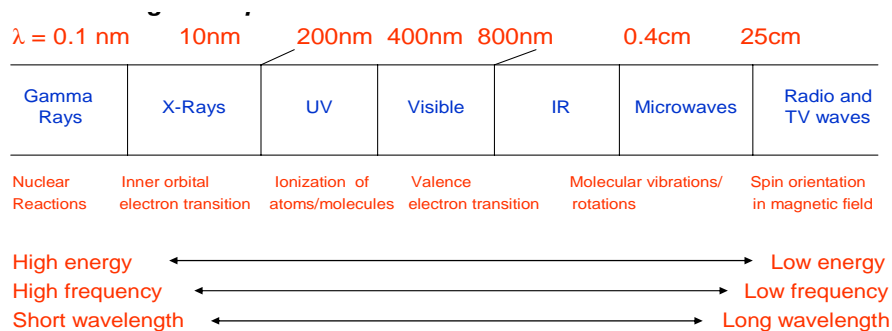

The following is short comparison between Ultra Violet (UV), Visible (Vis) and Infra Red (IR) ranges for the energy, frequency and wavelength:

**Energy: UV > Vis > IR**

**Frequency: UV > Vis > IR**

**Wavelength: UV < Vis < IR**

The symbol for the wavelength is “lambda” ( $\lambda$ ) and the unit is either nanometer (nm) or micrometer (or micron,  $\mu\text{m}$ ). The symbol for frequency is “nu” ( $\nu$ ) and the unit is either hertz or  $\text{sec}^{-1}$ . A parameter closely related to frequency is the wave number, which has the symbol “nu bar” ( $\bar{\nu}$ ) and the unit is  $\text{cm}^{-1}$ .

There are two levels by which the substances can interact with the light as, atomic level and molecular level and hence the corresponding techniques:

### 3.1.1 Atomic Level

#### 3.1.1a Atomic Absorption Spectroscopy (AAS):

**Principle:** The sample is vaporized by aspiration of solution into a flame or evaporation from electrically heated surface (temperature range: 1800 – 3100<sup>0</sup> K). At this condition where the individual atoms co-exist, a beam of light is passed through them. The atoms will absorb in the visible and ultraviolet region resulting in changes in electronic structure (excited state). So, the resultant light beam coming out of the sample will be missing the light in the corresponding wave length, which is a measure of the characteristics of the sample.

**Instrumentation:** Sources emitting radiation characteristic of element of interest (hollow - cathode lamp), flame or electrically heated furnace, monochromator, detector (photomultiplier) and recorder. The following is the simplified outline of the instrumentation:

**Fig: 2**

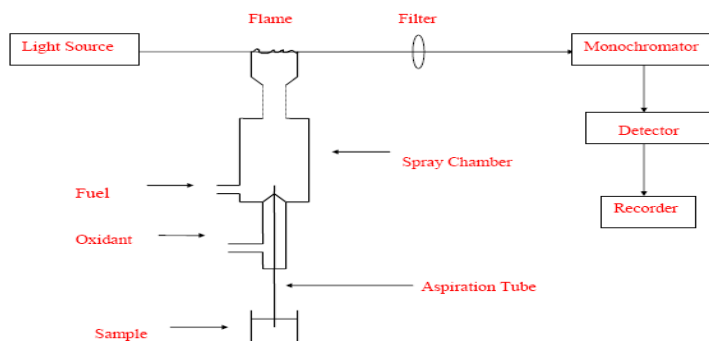

**Applications:** This is the most widely used technique for the quantitative determination of metals at trace levels (0.1 to 100ppm), which present in various materials. It utilizes **Beer - Lambert Law** for the analysis and a standard curve is obtained by plotting absorbance vs concentration of the samples taken. The usual procedure is to prepare a series of standard solutions over a concentration range suitable for the sample to be analysed. Then, the standards and the samples are separately aspirated into the flame, and the absorbances are read from the instrument. The plot will give the useful linear range and the concentrations of the samples can be found out from the plot.

**Disadvantages:** Sample must be in solution or at least volatile. Individual source lamp and filters needed for each element, since, each metal has its own characteristic absorption.

#### 3.1.1b Atomic Emission Spectroscopy (AES):

**Principle:** This is simply called as 'Flame Photometry', and measures the atoms excited by a **flame** (temperature range: 2000 – 3100<sup>0</sup> K) and not by light source as in the atomic absorption case. After excitation, atoms will readily lose the gained energy and revert back to the ground state and the emission occurs. It is that emission that actually being measured. The wavelengths of the emitted light will almost be similar as those that were absorbed in the atomic absorption, since exactly the same energy transitions occur, except in the order of reverse!



**Instrumentation:** A simple flame photometer consists of burner, nebulizer, monochromator, detector and recorder. The following is the simplified figure:

**Fig: 3**

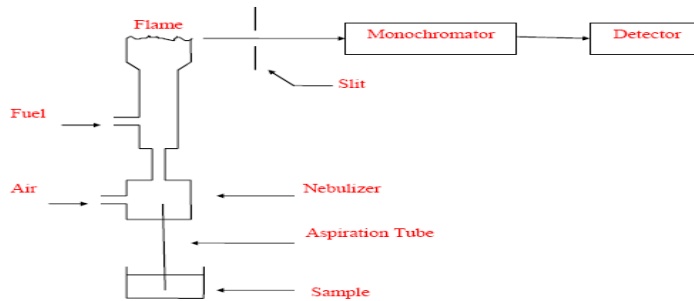

**Applications:** It is used exclusively in the quantitative determination of metals in solution, especially alkali and alkaline earth in the given samples. The principle is like that described for atomic absorption. Qualitative determination is also possible as each element emits its own characteristic line spectrum.

**Disadvantages:** Intensity of emission is very sensitive to changes in flame temperature. Usually, spectral interference and self-absorption are also encountered which affects the precision of the measurement. Further, a linear plot of absorbance against concentration is not always obtained.

### 3.1.1c Plasma Emission Spectroscopy:

**Principle:** Mostly referred as Inductively Coupled Plasma (ICP) Emission Spectroscopy, is also an atomic emission technique, most closely related to the preceded flame photometry except that the atoms and ions present in the sample are excited in high temperature gas plasma. Since the plasma provides very high temperature and hence the energy, almost all the atoms present in the sample can be excited with this technique ending up with high efficiency (a hotter source increases both atomization efficiency and excitation efficiency). Thus, the emissions from the atoms would be more intense and even very small concentrations of metals/metal ions can be detected and accurately measured.

**Instrumentation:** This is basically an emission spectrometer comprising nebulizer, RF coil, ICP Source (Argon plasma), monochromator, detector and recorder.

**Fig: 4**

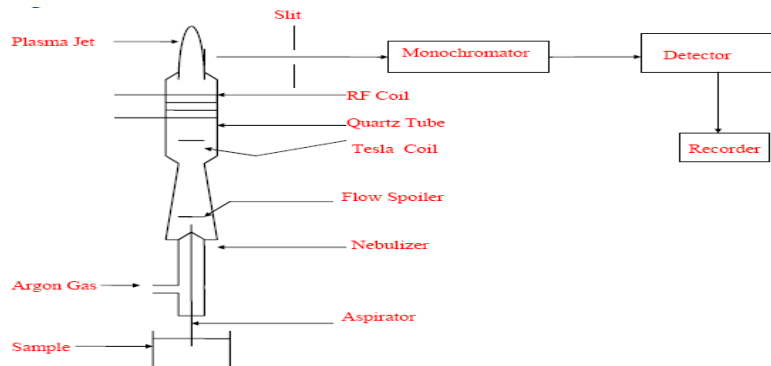

A plasma source or jet is a flame-like system of ionized, very hot flowing argon gas. At high temperatures ( $\approx 6000$  K) a gas such as argon will contain a high proportion of ions and free electrons constituting plasma (This ionisation is initiated by “Tesla” coil). Additional energy may be supplied to the electrons in the plasma by the application of an external electromagnetic field through RF coil. By collisions between the electrons and other species in the plasma this additional energy is uniformly distributed. As the collisions increase, the energy transfer becomes more efficient, which leads to a substantial temperature enhancement to a range of 8000 - 10000 K. It is the temperature at which the samples are introduced and analysed.

**Applications:** Similar to atomic emission spectroscopy but it covers very widespread for both qualitative and quantitative analysis of metals and some non-metals too, at trace levels. Because of the high temperature and homogeneity of the source, it offers better signal stability and hence the analytical precision. The technique when utilising an optical emission detector is termed as Inductively Coupled Plasma – Optical Emission Spectrometer (**ICP-OES**) and if it utilises a mass spectrometer (*refer section 9.6*) as detector then it is termed as Inductively Coupled Plasma – Mass Spectrometer (**ICP-MS**).

**Disadvantages:** Samples require dissolution before analysis. Instrumentation is complex and requires high operator’s skill and is very expensive.

### 3.1.1d Fluorometry: Atomic Fluorescence

This technique is not widely used though its counterpart - the molecular fluorescence is applied well to the analytical studies. The principle of atomic fluorescence is that when atoms are elevated to higher energy levels, they sometimes return to the ground state through a pathway, which has several intermediate electronic states, before reaching to the actual ground state. Such series of fall through the electronic levels accompany by light emission - which is atomic fluorescence. The intensity of this emitted light is measured at right angles to the incident light and related to concentration. Uses are similar to AAS and AES.

### 3.1.2 Molecular Level

#### 3.1.2a Ultraviolet - Visible Spectroscopy (UV/Vis):

**Principle:** It involves the absorption of electromagnetic radiation by the substances in the ultraviolet and visible regions of the spectrum. This will result in changes in the electronic structure of ions and molecules through the excitations of bonded and non-bonded electrons.

**Instrumentation:** It consists of a dual light source viz., tungsten lamp for visible range and deuterium lamp for ultraviolet region, grating monochromator, photo-detector, mirrors and glass or quartz cells.

**NOTE:** For measurements to be made under visible region both glass and quartz cells can be used. For the measurements under ultraviolet region, only quartz cell should be used, since, glass cells absorb ultraviolet rays.

There are two types of instrumental designs for this technique as single beam and double beam spectrophotometers. However double beam spectrophotometers are widely used and following is the outline of the instrument:

Fig: 5

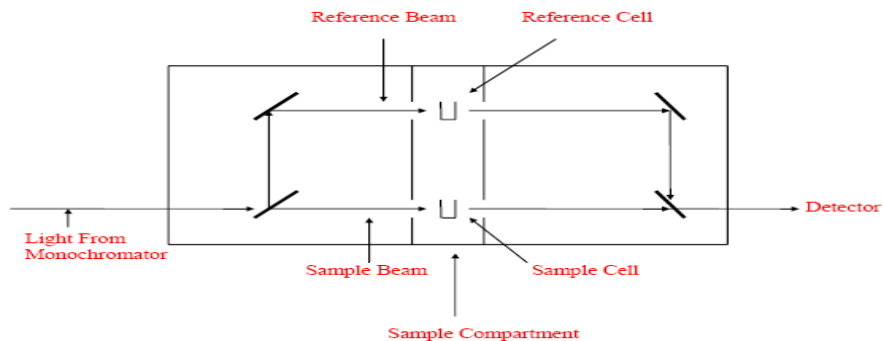

**Applications:** It is the most widely used technique for quantitative molecular analysis, for this Beer-Lambert law is applied. Sometimes it is used in conjunction with other techniques such as NMR, IR, etc., in the identification and structural analysis of organic compounds. For qualitative analysis it provides valuable information through the absorption spectrum which is unique for a given compound.

**Disadvantages:** Samples should be in solution. Mixture of substances poses difficult to analyse and requires prior separation. Interference from the sample's matrix makes the measurement difficult.

### 3.1.2b Fluorometry: Molecular Fluorescence

**Principle:** This technique utilises the phenomenon of molecular fluorescence, the theory behind this is exactly the same that has been discussed under atomic fluorescence but through the excitation of bonded electrons. Here, most often the irradiating light is in the range of ultraviolet and visible.

**Instrumentation:** The instrumental set-up comprises of a UV/Visible source, two monochromators, detector and recorder. The fluorescence exhibited by the sample is measured at right angles to the incident beam. The following is the basic set-up:

Fig: 6

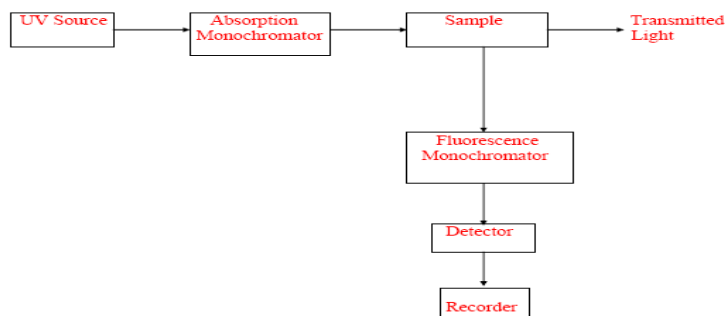

**Applications:** The applications of this technique are limited and it offers quantitative estimations of those compounds like benzene and fused benzene ring systems. Inorganic metals can also be analysed by the ability of them to form complexes with the ligands. It finds uses in the analysis of foods for vitamin content, since vitamins like riboflavin, niacin, etc., exhibit fluorescence. Only limited compounds show the fluorescence hence this technique is relatively free of any interference and is very sensitive.

**Disadvantages:** The application is very limited as relatively a few substances exhibit fluorescence.

### 3.1.2c Fourier Transform Infrared Spectroscopy (FT-IR):

**Principles:** It involves the absorption of electromagnetic radiation in the infrared region of the spectrum which results in changes in the *vibrational energy* of molecule. Since, usually all molecules will be having vibrations in the form of stretching, bending, etc., the absorbed energy will be utilised in changing the energy levels associated with them. It is a valuable and formidable tool in identifying organic compounds which have polar chemical bonds (such as OH, NH, CH, etc.) with good charge separation (strong dipoles).

**Instrumentation:** It was originally designed as a double beam spectrophotometer comprising IR source (red hot ceramic material), grating monochromator, thermocouple detector, cells made of either sodium chloride or potassium bromide materials, etc. In this process the light is dispersed by the monochromator. But, this type of basic design for IR measurements has been outdated. Instead a newer technique termed *Fourier Transform-Infrared (FT-IR)* has been in practice. This technique utilises a single beam of un-dispersed light and has the instrument components similar to the previous one.

In FT-IR, the un-dispersed light beam is passed through the sample and the absorbances at all wavelengths are received at the detector simultaneously. A computerized mathematical manipulation (known as “Fourier Transform”) is performed on this data, to obtain absorption data for each and every wavelength. To perform this type of calculations interference of light pattern is required for which the FT-IR instrumentation contains two mirrors, one fixed and one moveable with a beam splitter in between them. Before scanning the sample a reference or a blank scanning is required. The following is the simplified design of the instrument:

**Fig: 7**

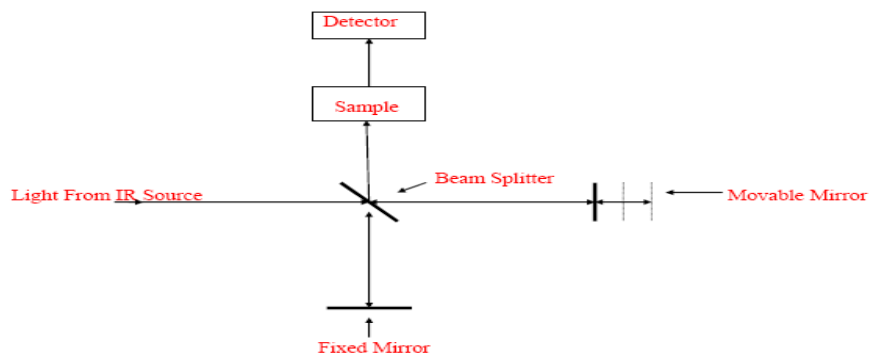

**Applications:** It finds extensive use in the identification and structural analysis of organic compounds, natural products, polymers, etc. The presence of particular functional group in a given organic compound can be identified. Since every functional group has unique vibrational energy, the IR spectra can be seen as their fingerprints.

**Disadvantages:** Samples containing mixture of substances can not be analysed. Since the sample holders and beam splitter, are made of moisture sensitive materials like sodium chloride or potassium bromide (KBr), special cells are required for aqueous samples (e.g. KRS-5, ZnSe, etc.). Water is a bad solvent for IR spectral works.

### 3.1.2d Fourier Transform Raman Spectroscopy (FT-Raman):

**Principle:** This technique is complementary to FT-IR and is a scattering technique, whereby a laser beam (near-IR region) is directed to the sample and the scattered radiation is collected. Most of the scattered radiation has the same wavenumber as that of the incident laser beam, however a fraction will be having a different wavenumber. This is the Raman signal and characteristic of particular functional group. Raman spectroscopy finds applications in identifying organic compounds containing non-polar bonds such as carbon - carbon double bonds or aromatic rings (weak dipoles).

**Instrumentation:** The instrumentation comprises of exciting laser normally in near-IR region, Rayleigh filter, beam splitter, detector, etc. Data collection and processing are akin to IR including the Fourier transformations.

**Fig: 8**

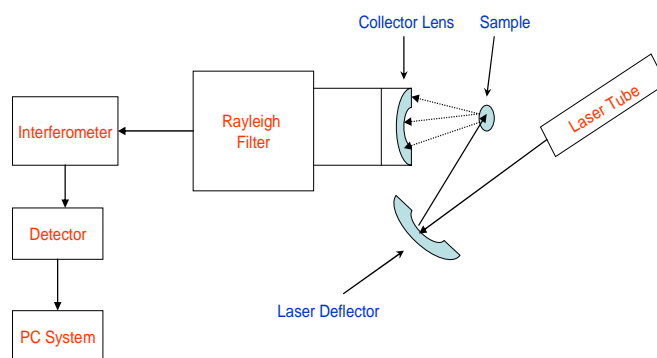

**Applications:** The applications are similar to FT-IR and gives useful information on the non-polar bonds, i.e. bonds with null or reduced dipole moment. Water is a good solvent for FT-Raman.

**Disadvantages:** Signal strength is normally weak, and liquid samples give poor signals. Heat sensitive samples can't be analyzed, since local heating will damage the samples. Dark colored samples can't be analyzed.

### 3.1.2e Microwave Spectroscopy:

This technique is actually an extension to IR spectroscopy. Microwave region lies at the far infra-red region of the electromagnetic spectrum and its absorption by molecules give rise to change in the *rotational energies* of the molecules. In IR spectroscopy, the molecules are subjected to changes in vibrational energies; the energy required for making changes at rotational levels is lesser than that for vibrational levels. Though the principles are same to that of IR, the instrumentation is slightly different and it requires samples in *gaseous state* for the analysis. Its applications are limited to smaller and simpler molecules since larger molecules will have interactions between the rotational energy levels within the molecule through various bonds they have. Besides qualitative analysis, this technique can be applied for conformational analysis of simpler compounds (study of stereo chemistry of the compounds).

### 3.1.2f Nuclear Magnetic Resonance Spectroscopy (NMR):

**Principle:** In NMR substances absorb energy in the radio frequency region of the electromagnetic spectrum under influence of a strong magnetic field. It is a well known fact that the nuclei of the atoms bonded to each other in molecules spin on an axis like a top. Since nuclei are positively charged, this spin will create a small magnetic field. If an external magnetic field is applied to these nuclei this magnetic field will split into two energy levels. The energy difference is very small and corresponds to radiofrequency energy which is unique for every molecule and will give the information regarding the nature of the compounds and the presence of various functional groups and their environment.

Since this technique is mostly measures the spinning of the hydrogen nuclei (almost all the organic compounds contain hydrogen atoms!), it is sometimes referred as **Proton Magnetic Resonance (PMR)** spectroscopy.

**Instrumentation:** The instrumentation for this technique includes powerful magnet, radio-frequency signal generator, amplifier, detector, etc. The following is the outline of the instrument:

**Fig: 9**

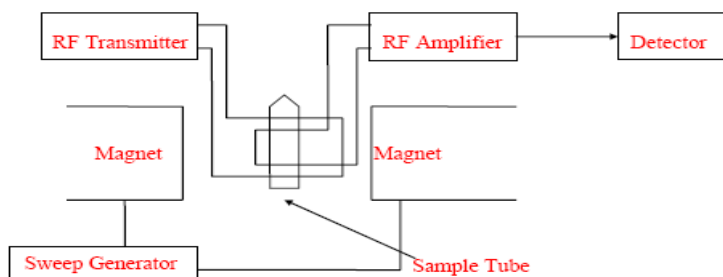

**Applications:** The application lies mostly in the identification and structural analysis of organic compounds and thus, it is mostly a tool for qualitative analysis. It gives valuable information regarding the position of the functional groups in a molecule and provides distinguished spectra for the isomer. Much precise information on the structure of the compounds can be obtained using the same technique with other magnetic nuclei like  $C^{13}$ ,  $O^{17}$ , the instrumentation being the same except that the sweep of the magnetic field is varied.

**Disadvantages:** Very expensive and the instrumentation is complex and needs exceptional skills to operate. Its sensitivity ranges from moderate to poor, however, can get clear information using  $C^{13}$  or  $O^{17}$  NMR. The usage of the solvents is limited and in most of the situations deuterated solvents are required.

### 3.1.2g Electron Spin Resonance Spectroscopy (ESR):

The basic principle of electron spin resonance spectroscopy is that, electrons always have a spin and thus have a magnetic moment. Thus, the magnetic resonance theory applies to electrons too like that of nuclei, as in NMR. Especially this technique is of high value when it comes to the compounds which contain odd electrons, i.e. those substances which have paramagnetic behaviour (if electrons are paired as in bonded orbital then their mutual spinning will cancel each other and there will be no response for the applied magnetic field,

whereas, if it is unpaired then it can align with the applied magnetic field and the feasibility of getting ESR spectra is higher). Thus, the principle and the instrumentation are much similar to that of NMR technique. It is also referred as, *Electron Magnetic Resonance (EMR)* or *Electron Paramagnetic Resonance (EPR)* spectroscopy.

It is mostly used as a potential technique to study the formation and lifetime of free radicals, which are the major intermediates in most of the organic reactions. Another important application is in the estimation of trace amounts of paramagnetic ions, particularly in biological works like,  $Mn^{2+}$ ,  $Mg^{2+}$ , etc.

## 4. ANALYSIS THROUGH CHROMATOGRAPHY

The technique through which the chemical components present in complex mixtures are separated, identified and determined is termed as chromatography. This technique is widely used like spectroscopy and is a very powerful tool not only for analytical methods but also for preparative methods. Compounds of high grade purity can be obtained by this method. Chromatography can be simply defined as follows:

*“It is the technique in which the components of a mixture are separated based upon the rates at which they are carried or moved through a stationary phase (column) by a gaseous or liquid mobile phase”.*

Based on the mobile phase this technique can be simply classified into two categories as: *Liquid Chromatography* and *Gas Chromatography*. The column which holds the stationary phase (which in the form of small particles of the diameter of the order in microns), plays unique role in these processes. Usually silica is the base material for producing this phase.

### 4.1 LIQUID CHROMATOGRAPHY (LC/HPLC)

*Principle:* Early liquid chromatography was carried out in long glass columns with wide diameter. The diameters of the stacked particles inside the column were of the order of 150-200 microns range. Even then, the flow rates (eluent time) of the mobile phase with the analyte were very slow and separation times were long - often several hours!. With the advent of latest technology the particle diameters were reduced as small as to 10 microns with replacement of glass columns with steel ones. The flow rate of the mobile phase was improved by applying high pressure to the column using pumps and hence the performance was improved. This development led the instrument to be mostly called as “*High-Performance Liquid Chromatography*” or “*High-Pressure Liquid Chromatography*” (*HPLC*). Though HPLC retains major of the credits to the analytical side, the earlier one of simple Liquid Chromatography still finds applications in the preparative purposes.

The HPLC technique can be divided into four main categories depending on the nature of the processes that occur at the columns as follow:

**4.1.1 High-Performance Adsorption Chromatography:** Here the analyte species (components to be analysed) are adsorbed onto the surface of a polar packing. The stationary phase consists of finely divided solid particles packed inside a steel tube. If the component mixture is eluted through this tube with the mobile phase, different components present in the mixture adsorb to different degrees of strength and they become separated as the mobile phase moves steadily through the column. The nature of the adsorption involves the interaction of polar molecules with a very polar solid stationary phase. The stationary phase could be silica gel or alumina. This method is extensively used for the separations of relatively non-polar, water-insoluble organic compounds (since polar molecules will be adsorbed on to the column momentarily). One particular application is in resolving isomeric mixtures such as *meta*- and *para*-substituted benzene derivatives.

**4.1.2 High-Performance Partition Chromatography:** It is the most widely used liquid chromatographic procedures to separate most kinds of organic molecules. Here the components present in the analyte mixture distribute (or partition) themselves between the mobile phase and stationary phase as the mobile phase moves through the column. The stationary phase actually consists of a thin liquid film either adsorbed or chemically bonded to the surface of finely divided solid particles. Of these the latter is considered more important and has a distinct stability advantage. It is not removed from the solid phase either by reaction or by heat and hence it is more popular. It finds wide applications in various fields, viz., pharmaceuticals, bio-chemicals, food products, industrial chemicals, pollutants, forensic chemistry, clinical medicine, etc.

**4.1.3 High-Performance Ion-Exchange Chromatography:** This method is used to separate mixtures of ions (organic or inorganic), and finds its application mostly in protein separations. The stationary phase consists of very small polymer resin “beads” which have many ionic bonding sites on their surface, termed as Ion Exchange Resins. This resin can be either an [anion exchange resin](#), which possesses positively charged sites to attract negative ions, or a [cation exchange resin](#), which possesses negatively charge sites to attract positive ions. If the analyte mixture which contains mixture of ions is introduced into the column packed with suitable ion-exchange resin, selected ions will be attached or bonded on to the resin, thus being separated from other species that do not bond. Later, these attached ions can be dislodged from the column by repeated elution with a solution that contains an ion that competes for the charged groups on the resin surface, in other words, which has high affinity for the charged sites on the resin than the analyte ions. Thus the analyte ions get exchanged and separated from the column.

**4.1.4 High Performance Size Exclusion Chromatography:** This technique is for separating dissolved species on the basis of their size and particularly applicable to high-molecular-weight species like oligomers and polymers to determine their relative sizes and molecular weight distributions. Here, the stationary phase is polymer resin, which contains small pores. If the components to be separated are passed through the column the small sized particles can easily enter into these pores and their mobility is retarded. Whereas the large sized particles, which can't enter into these pores can come out of the column fast and elude first. Thus the separation of various sized particles is possible through variations in the elution time. It is classified into two categories based on the nature of the columns and their packing as:



Gel Filtration Chromatography - which uses hydrophilic packing to separate polar species and uses mostly aqueous mobile phases. This technique is mostly used to identify the molecular weights of large sized proteins & bio-molecules.

Gel Permeation Chromatography - which uses hydrophobic packing to separate nonpolar species and uses nonpolar organic solvents. This technique is used to identify the molecular weights of polymers.

**Instrumentation:** The basic HPLC system consists of a solvent (mobile phase) reservoir, pump, degasser, injection device, column and detector. The pump draws the mobile phase from the reservoir and pumps it to the column through the injector. At the end of the column (effluent end), a detector is positioned. Mostly UV absorption detector is used. In the case of analytical studies, after the detection the eluents are collected in waste bottles. In the case of preparative studies the eluents are fractionally collected for further studies. Most of the HPLC design will be the same as described for all the four main groups previously described. However, there can be differences in selecting the specific detectors for particular type of analysis, say for example, with ion-exchange chromatography, detectors commonly used are conductivity detectors for obvious reasons. Other important detectors for HPLC separations include refractive index detector, fluorescence detector and mass selective detector. The following is the most generalised outlay of the HPLC system:

**Fig: 10**

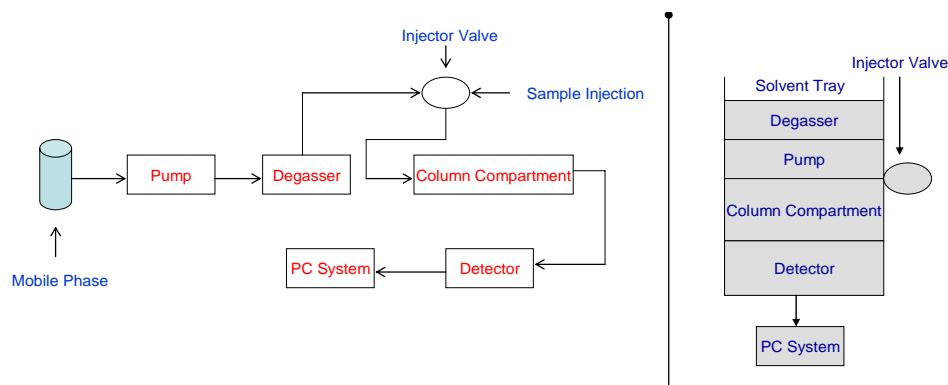

**Disadvantages:** Column performance is very sensitive, which depends on the method of packing. Further, no universal and sensitive detection system is available.

## 4.2 GAS CHROMATOGRAPHY (GC)

**Principle:** Here an inert carrier gas (Helium or Nitrogen) acts as the mobile phase. This will carry the components of analyte mixture and elutes through the column. The column usually contains an immobilized stationary phase. The technique can be categorised depending on the type of stationary phase as follow:

Gas Solid Chromatography (GSC) - here the stationary phase is a solid which has a large surface area at which adsorption of components of the analyte takes place. The separation is possible based on the differences in the adsorption power and diffusion of gaseous analyte molecules. The application of this method is limited and is mostly used in the separation of the low-molecular-weight gaseous species like carbon monoxide, oxygen, nitrogen and lower hydrocarbons.

Gas Liquid Chromatography (GLC) - this is the most important and widely used method for separating and determining the chemical components of volatile organic mixtures. Here the stationary phase is a liquid that is immobilized on the surface of a solid support by adsorption or by chemical bonding. The separation of the mixture into individual components is by distribution ratio (partition) of these analyte components between the gaseous phase and the immobilized liquid phase. Because of its wide applications most of the GCs are configured for the GLC technique.

**Instrumentation:** The instrumentation for GC is different from that of HPLC in that the injection port, column and detector are to be heated to a pre-specified temperature. Since the mobile phase here is a gas (carrier gas) the components present in the analyte mixture should be vaporised, so that it can be effectively carried through the column. The basic instrumentation for GC includes a carrier gas cylinder with regulator, a flow controller for the gas, an injection port for introducing the sample, the column, the detector and the recorder. An outlay is as follow:

**Fig: 11**

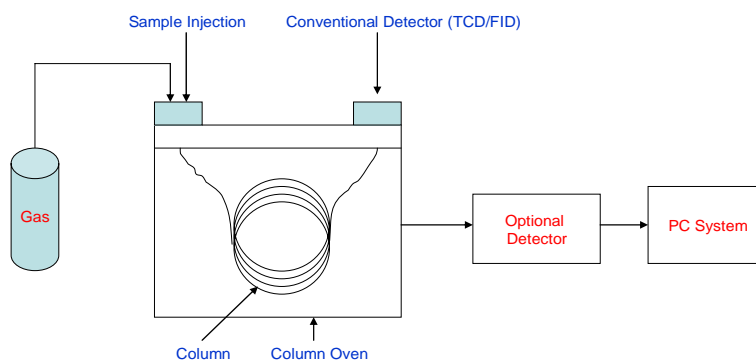

In the above illustration the injection port, column oven and detector are hot zones. The success of this technique requires the appropriate selection of the column and the temperature conditions at which the column to be maintained throughout the analysis. Basically the columns for GC are classified as analytical columns and preparative columns. The analytical columns are of two types: *packed column* and *open-tubular or capillary column*. Both differ in the way the stationary phases are stacked inside.

In the instrumentation of GC detectors play unique role. There are a number of detectors, which vary in design, sensitivity and selectivity. Detectors in GC are designed to generate an electronic signal when a gas other than the carrier gas elutes from the column. Few examples and applications of the detectors are:

Thermal Conductivity Detector (TCD) - this operates on the principle that gases eluting from the column have thermal conductivity different from that of the carrier gas. It is the universal detector (detects most of the analytes) and is non-destructive and hence used with preparative GC, but less sensitive than other detectors.

Flame Ionization Detector (FID) - it is one of the important detectors where the column effluent is passed into a hydrogen flame and the flammable components are burned. In this process a fraction of the molecules gets fragmented into charged species as positive and

negative. While positively charged ions are drawn to a collector, negatively charged ions are attracted to positively charged burner head, this creates an electric circuit and the signal is amplified. The FID detector is very sensitive, but destroys the sample by burning. It only detects organic substances that burn and fragment in a hydrogen flame (e.g. hydrocarbons). Hence its usage is restricted for preparative GC and for inorganic substances which do not burn.

Electron Capture Detector (ECD) - this is another type of ionization detector which utilises the beta emissions of a radioactive source, often nickel-63, to cause the ionization of the carrier gas molecules, thus generating electrons which constitute an electrical current. This detector is used for environmental and bio-medical applications. It is especially useful for large halogenated hydrocarbons and hence in the analysis of halogenated pesticide residues found in environmental and bio-medical samples. It is extremely sensitive. It does not destroy the sample and thus may be used for the preparative work.

Nitrogen/Phosphorus Detector (NPD) - the design of the detector is same to that of the FID detector except that a bead of alkali metal salt is positioned just above the flame. It is also known as 'Thermionic Detector'. It is useful for the phosphorus and nitrogen containing pesticides, the organophosphates and carbamates. The sensitivity for these compounds are very high since the fragmentation of the other organic compounds are minimized.

Flame Photometric Detector (FPD) - here a flame photometer is incorporated into the instrument. The principle is that the sulfur or phosphorus compounds burn in the hydrogen flame and produce light emitting species. This detector is specific for organic compounds containing sulphur or phosphorus. It is very selective and very sensitive.

Electrolytic Conductivity Detector (ECD Hall) - this otherwise known as 'Hall detector', converts the eluting gaseous components into ions in liquid solution and then measures the electrolytic conductivity of the solution in a conductivity cell. The conversion to ions is done by chemically oxidizing or reducing the components with a "reaction gas" in a small reaction chamber. This detector is used in the analysis of organic halides and has excellent sensitivity & selectivity, but is a destructive detector.

The recent developments allow the GC to be coupled with other analytical techniques like Infra Red Spectrometry (Gas Chromatography-Infrared Spectrometry, GC-IR) and Mass Spectrometry (Gas Chromatography- Mass Spectrometry, GC-MS). These are termed as '**hyphenated techniques**', and are very efficient for qualitative analysis as very accurate and precise information like mass or IR spectrum of the individual sample components are readily obtained as they elute from the GC column. It saves time and reduces the steps involved for a component to be separated and analysed.

**Disadvantages:** Samples must be volatile and thermally stable below about 400° C. No single universal detector is available and most commonly used detectors are non-selective. One should take much care in the analytical steps starting from the selection of the column, the detector and must define the temperatures of all the three ports viz., injection port, column oven and detector. An improper programming on these will lead to erratic results.

## 5. ANALYSIS THROUGH THERMAL ENERGY

### 5.1 THERMAL ANALYSIS

The technique of thermal analysis actually comprises of a series of methods, which detect the changes in the physical and mechanical properties of the given substance by the application of heat or thermal energy. The physical properties include mass, temperature, enthalpy, dimension, dynamic characteristics, etc. It finds its application in finding the purity, integrity, crystallinity and thermal stability of the chemical substances under study. Sometimes it is used in the determination of the composition of complex mixtures. This technique has been adopted as testing standard in quality control in the production field, process control and material inspection. It is applied in wide fields, including, polymer, glass, ceramics, metals, explosives, semiconductors, medicines and foods. The following are the popular methods under this technique:

#### 5.1.1 Thermogravimetric Analysis (TGA):

In this technique the change in sample weight is measured while the sample is heated at a constant rate (or at constant temperature), under air (oxidative) or nitrogen (inert) atmosphere. This technique is effective for quantitative analysis of thermal reactions that are accompanied by mass changes, such as evaporation, decomposition, gas absorption, desorption and dehydration. The following is the simplified diagram for the instrumentation:

**Fig: 12**

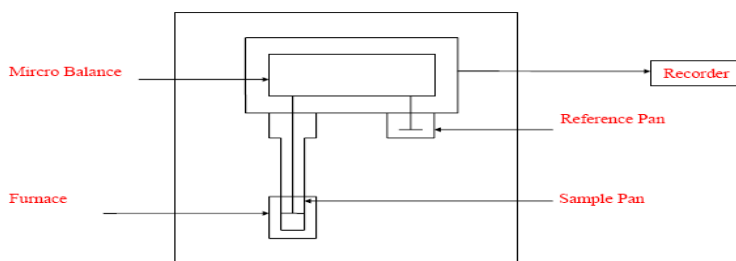

The micro-balance plays a significant role, during measurement the change in sample mass affects the equilibrium of the balance. This imbalance is fed back to a force coil, which generates additional electromagnetic force to recover equilibrium. The amount of additional electromagnetic force is proportional to the mass change. During the heating process the temperature may go as high as 1500° C inside the furnace.

#### 5.1.2 Thermomechanical Analysis (TMA):

Thermomechanical analysis is the measurement of a material's behaviour, ie. expansion or contraction, when temperature and a load is applied. A scan of dimensional changes related to temperature (at constant load) or load (at constant temperature) provides valuable information about the sample's mechanical properties. One of the most important applications of TMA is the characterization of composite and laminate materials, through the study of glass transition temperature and the expansion coefficient. Another application is in the quantitative measurement of extension and contraction observed in textile fibres, thin films and similar materials.

#### 5.1.3 Differential Thermal Analysis (DTA):

This technique measures the temperature difference between a sample and a reference material as a function of temperature as they are heated or cooled or kept at a constant temperature (isothermal). Here the sample and reference material are simultaneously heated

or cooled at a constant rate. Reaction or transition temperatures are then measured as a function of the temperature difference between the sample and reference. It provides vital information of the materials regarding their endothermic and exothermic behaviour at high temperatures. It finds most of its applications in analysing and characterising clay materials, ceramic, ores, etc.

#### 5.1.4 Differential Scanning Calorimeter (DSC):

This technique is more or less similar to DTA except that it measures the amount of heat absorbed or released by a sample as it is heated or cooled or kept at constant temperature (isothermal). Here the sample and reference material are simultaneously heated or cooled at a constant rate. The difference in temperature between them is proportional to the difference in heat flow (from the heating source i.e. furnace), between the two materials. It is the well-suited technique in the detection and further studies of liquid crystals. This technique is applied to most of the polymers in evaluating the curing process of the thermoset materials as well as in determining the heat of melting and melting point of thermoplastic polymers, glass transition temperature ( $T_g$ ), endothermic & exothermic behaviour. Through the adjunct process of isothermal crystallization it provides information regarding the molecular weight and structural differences between very similar materials. The instrumentation is exactly similar to that of DTA except for the difference in obtaining the results.

**Fig: 13 (DSC/DTA)**

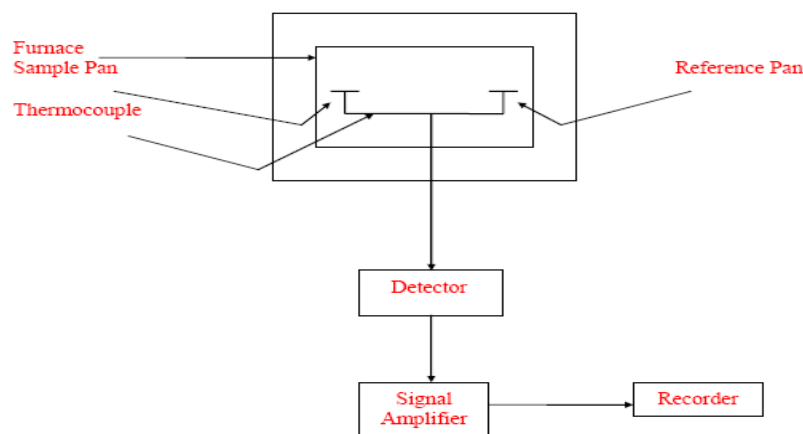

## 6. ANALYSIS THROUGH X-RAY TECHNIQUES

**6.1 Generation of X-Rays:** When metals, like copper, molybdenum, tungsten, etc., are bombarded directly with a stream of high energy electrons or radioactive particles, X-rays (wavelengths of order 0.1-100Å) are emitted because of the transitions involving K-Shell and L-Shell electrons. This can be simply expressed as follows:

A cathode in the form of a metal wire when electrically heated gives off electrons. If a positive voltage, in the form of an anode (target comprised of the metals mentioned above), is placed near these electrons, the electrons are accelerated toward the anode. Upon striking the anode, the electrons transfer their energy to the metallic surface, which then gives off X-ray radiation. This is referred as *primary X-rays*.

The following is the schematic diagram for the process:

Fig: 14

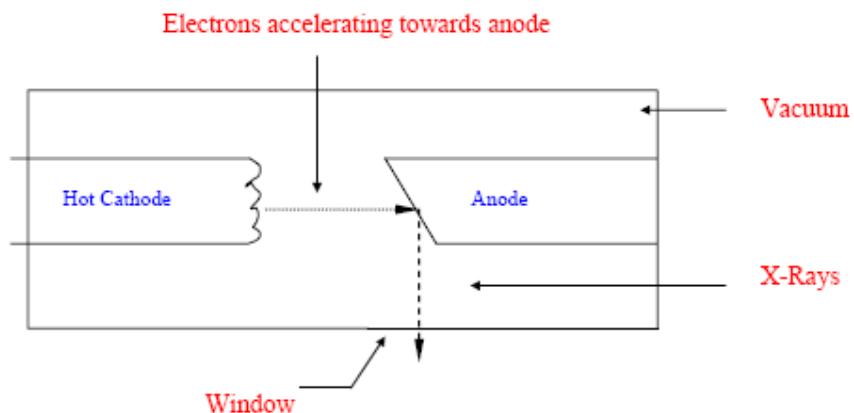

*Note: The wavelength of the emitted X-ray is characteristic of the element being bombarded. Hence with some modifications this process can be used as a tool for qualitative and quantitative elemental analysis by measuring the wavelength and emission intensity of the X-rays respectively. This forms the basis for Electron Probe Microanalysis! (Ref: Sec 7.1)*

### 6.2 X-Ray Fluorescence Spectrometry (XFS):

*Principle:* When a sample is placed in a beam of primary X-rays, part of it will be absorbed and the atoms get excited, by the ejection of electrons present in K and L shells. While relaxing they re-emit X-rays of characteristic wavelength. This re-emitted X-rays are called *secondary or fluorescent X-rays* and hence the name for this technique. Since, the wavelength of the fluorescence is characteristic of the element being excited, measurement of the wavelength and intensity enables to carry out the qualitative and quantitative analyses.

*Instrumentation:* It comprises of a source for primary X-rays, collimators, analyzing crystal and detector.

*Applications:* It is one of the non-destructive methods in the elemental analysis of solid or liquid samples for major and minor constituents. Most of the elements in the periodic table, both metals and nonmetals, respond to this technique. Detection limit is between 10 to 100 ppm. One of the significant uses of this method is in the medical field in identifying and determining the sulfur in protein.

Fig: 15

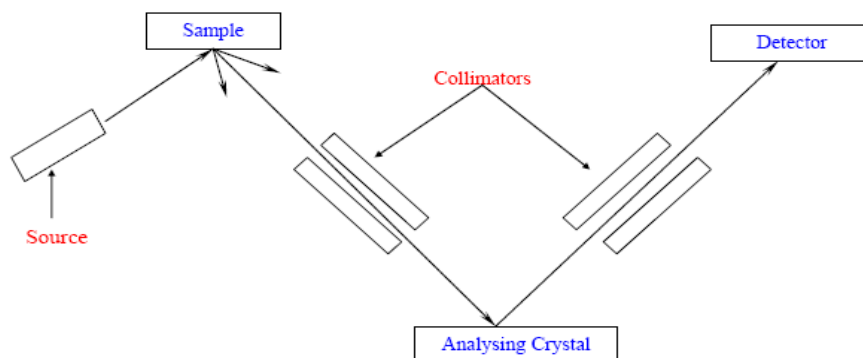

**Disadvantages:** The sensitivity gets affected for elements with lower atomic numbers, particularly elements with atomic number lower than 15 are difficult to analyze. The sensitivity is also limited by matrix absorption, secondary fluorescence and scattering of the particles. Instruments are often large, complicated and costly.

### 6.3 X-Ray Photo-emission Spectrometry (XPS):

**Principle:** When a primary X-ray beam of precisely known energy impinges on sample atoms, inner shell electrons are ejected and the *energy of the ejected electrons* is measured. The difference in the energy of the impinging X-ray and the ejected electrons gives the binding energy ( $E_b$ ) of the electron to the atom. Since, this binding energy of the emitted electron depends on the energy of the electronic orbit and the element it can be used to identify the element involved. Further, the chemical form or environment of the atom affects the binding energy to a considerable extent to give rise to some *chemical shift*, which can be used to identify the valence state of the atom and its exact chemical form. This technique is mostly referred as **Electron Spectroscopy for Chemical Analysis (ESCA)**.

An associated process with this method is that when the electron is ejected from the inner orbital a vacancy is left with. Hence, another electron from the outer orbits may fall to fill the vacancy and by doing so emits X-ray fluorescence. The energy of this X-ray fluorescence is sometimes transferred to a second electron to make it to be ejected. This second electron thus emitted is termed as *Auger electron* and the method *Auger Spectroscopy* (after French Physicist *Pierre Auger*). Its applications are more or less similar to ESCA and both the methods are used in conjunction since in both cases the energies involved are similar.

**Instrumentation:** It consists of a radiation source for primary X-rays, monochromator, the energy analyzer (to resolve the electrons generated from the samples by energy) and detector to measure the intensity of the resolved electrons. The analysis is done in high vacuum.

**Fig: 16**

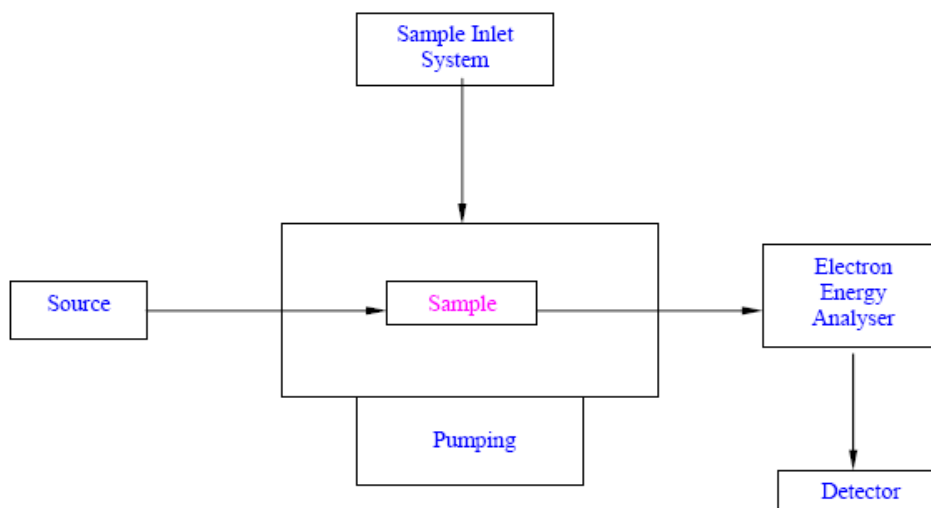

**Applications:** It is mainly used for surface analysis, especially in the qualitative identification of the elements in a sample. Based on the chemical shifts, the chemical environment around the atoms can also be estimated. This measurement is useful in determining the valence states of the atoms present in various moieties in a sample. Quantitative measurements can be made by determining the intensity of the ESCA lines of each element.

**Disadvantages:** High vacuum is necessary for the system to avoid the low energy electrons to be collided with other impurities, which may result in low sensitivity. It is not possible to detect the impurities at the ppm or ppb levels. The whole instrumentation is highly complicated.

#### 6.4 X-Ray Diffractometry (XRD):

**Principle:** In this technique the primary X-rays are made to fall on the sample substance under study. Because of its wave nature, like light waves, it gets diffracted to a certain angle. This angle of diffraction, which differs from that of the incident beam, will give the information regarding the crystal nature of the substance. The wavelength of the X-rays can be varied for the application by using a grating plate.

**Instrumentation:** It consists of X-ray tube for the source, monochromator and a rotating detector.

**Fig: 17**

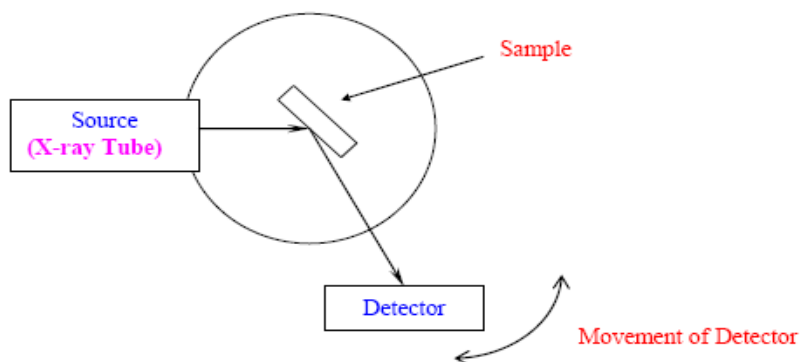

**Applications:** The diffraction of X-rays is a good tool to study the nature of the crystalline substances. In crystals the ions or molecules are arranged in well-defined positions in planes in three dimensions. The impinging X-rays are reflected by each crystal plane. Since the spacing between the atoms and hence the planes can't be same or identical for any two chemical substances, this technique provides vital information regarding the arrangement of atoms and the spacing in between them and also to find out the chemical compositions of crystalline substances. The sample under study can be of either a thin layer of crystal or in a powder form. Since, the power of a diffracted beam is dependent on the quantity of the corresponding crystalline substance, it is also possible to carry out quantitative determinations.



## 7. ANALYSIS THROUGH MICROSCOPY

The techniques described here are not for the simple, ordinary optical microscopes which use light for the magnification. These employ electron beam and mechanical probes to magnify the surfaces under study.

### 7.1 Scanning Electron Microscopy (SEM):

**Principle:** In this technique, an electron beam is focused onto the sample surface kept in a vacuum by electro-magnetic lenses (since electron possesses dual nature with properties of both particle and wave an electron beam can be focused or condensed like an ordinary light) The beam is then rastered or scanned over the surface of the sample. The scattered electron from the sample is then fed to the detector and then to a cathode ray tube through an amplifier, where the images are formed, which gives the information on the surface of the sample.

**Instrumentation:** It comprises of a heated filament as source of electron beam, condenser lenses, aperture, evacuated chamber for placing the sample, electron detector, amplifier, CRT with image forming electronics, etc.

**Fig: 18**

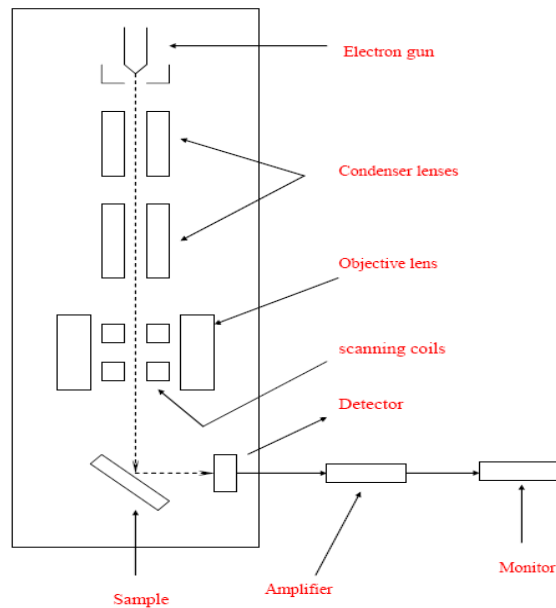

**Applications:** Scanning electron microscopy has been applied to the surface studies of metals, ceramics, polymers, composites and biological materials for both topography as well as compositional analysis. An extension (or sometimes conjunction to SEM) of this technique is **Electron Probe Micro Analysis (EPMA)**, where the emission of X-rays, from the sample surface, is studied upon exposure to a beam of high energy electrons. Depending on the type of detectors used this method is classified in to two as: **Energy Dispersive Spectrometry (EDS)** and **Wavelength Dispersive Spectrometry (WDS)**. This technique is used extensively in the analysis of metallic and ceramic inclusions, inclusions in polymeric materials, diffusion profiles in electronic components.

**Disadvantages:** The instrumentation is complicated and needs high vacuum for the optimum performance.

## 7.2 Transmission Electron Microscopy (TEM):

**Principle:** In this technique, a beam of high-energy electrons (typically 100 - 400keV) is collimated by magnetic lenses and allowed to pass through a specimen under high vacuum. The transmitted beam and a number of diffracted beams can form a resultant diffraction pattern, which is imaged on a fluorescent screen kept below the specimen. The diffraction pattern gives the information regarding lattice spacing and symmetry of the structure under consideration. Alternatively, either the transmitted beam or one of the diffracted beams can be made to form a magnified image of the sample on the viewing screen as bright-and dark-field imaging modes respectively, which give information about the size and shape of the micro-structural constituents of the material. High-resolution image, that contains information about the atomic structure of the material, can be obtained by recombining the transmitted beam and diffracted beams together.

**Instrumentation:** It comprises of a tungsten filament or LaB<sub>6</sub> or a field emission gun as source of electron beam, objective lens, imaging lens, CCD camera, monitor, etc.

**Applications:** Transmission electron microscopy is used to study the local structures, morphology, and dispersion of multi-component polymers, cross sections & crystallization of metallic alloys and semiconductors, microstructure of composite materials, etc. The instrument can be extended to include other detectors like Energy Dispersive Spectrometer (EDS) or Energy Loss Spectrometer (ELS) to study about the local chemistry of the material similar to SEM technique.

**Disadvantages:** The instrumentation is complicated and needs high vacuum. Sample preparation is very time consuming. Some materials, especially polymers, are sensitive to electron beam irradiation which results in the loss of crystallinity and/or mass.

**Fig: 19**

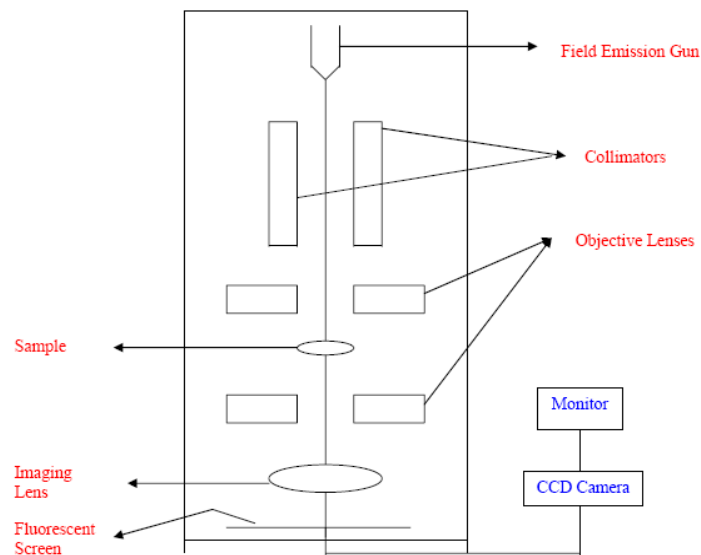

### 7.3 Scanning Probe Microscopy (SPM):

The scanning probe microscopy is a general term for a wide variety of microscopic techniques, which measure the morphology and properties of surfaces on the atomic scale. This includes the following:

*Scanning Tunneling Microscopy (STM)* – which studies the surface topography and electronic structure, *Atomic Force Microscopy (AFM)* – which studies the surface topography, surface hardness and elastic modulus, *Lateral Force Microscopy (LFM)* – which studies the relative frictional properties, *Scanning Thermal Microscopy (SThM)* – which studies the thermal conductivity, *Magnetic Force & Electric Force Microscopies (MFM & EFM)* – which study the magnetic and electric properties.

The techniques of STM and AFM are discussed below, since these are widely used:

**Principle:** The general principle for all the scanning probe microscopes is that a sharper probe (or a very fine tip) is used to scan the surface of the sample with much lower force and obtain the topography and morphology information.

**Scanning tunneling microscope:** When a sharp tip made of a *conducting material* is brought close to a *conducting sample*, overlapping of the electron clouds between the two surfaces will occur. If a potential is given between them a current of electrons is formed, which is often referred as “*tunneling*” *current*, and the effect is known as “*tunneling*” *effect*. This effect is largely depended on the distance between the tip and the sample material. Hence, if the scanning tip is controlled by a high precision motion device made of piezo-electric material, the distance between the tip and the sample can be measured during a scanning through a feedback loop control of the piezo-electric element. By this way the sample can be scanned with sub-angstrom precision.

**Atomic force microscope:** This technique operates by measuring the forces between the sample and the tip, and the sample need not be a conducting material. Here, the tip is brought close enough to the sample surface to detect the *repulsive force* between the atoms of the tip material and the sample. The probe tip is mounted at the end of a cantilever of a low spring constant and the tip-to-sample spacing is held fixed by maintaining a constant and very low force on the cantilever. Hence, if the tip is brought close to the sample surface, the repulsive force will induce a bending of the cantilever. This bending can be detected by a laser beam, which is reflected off the back of the cantilever. Thus by monitoring the deflection of the cantilever, the surface topography of the sample can be tracked. Since the force maintained on the cantilever is in the range of inter-atomic forces (about  $10^{-9}$  Newton), this technique derived the name “*atomic force*” *microscopy*.

AFM operates at two modes:

Repulsive or contact mode – which detects the repulsive forces between the tip and sample;

Attractive or non-contact mode – which detects the van der waals forces that act between the tip and sample.

**Instrumentation:**

*Scanning tunneling microscope:* It mainly consists of a scanner, probe motion sensor composed of piezo-electric material, micro probe, etc.

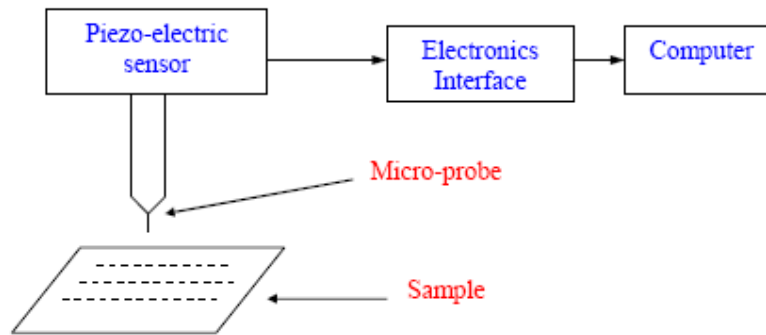
**Fig: 20**

*Atomic force microscope:* It mainly consists of a scanner, cantilever, laser source, photo-diode detector, micro-probe, etc.

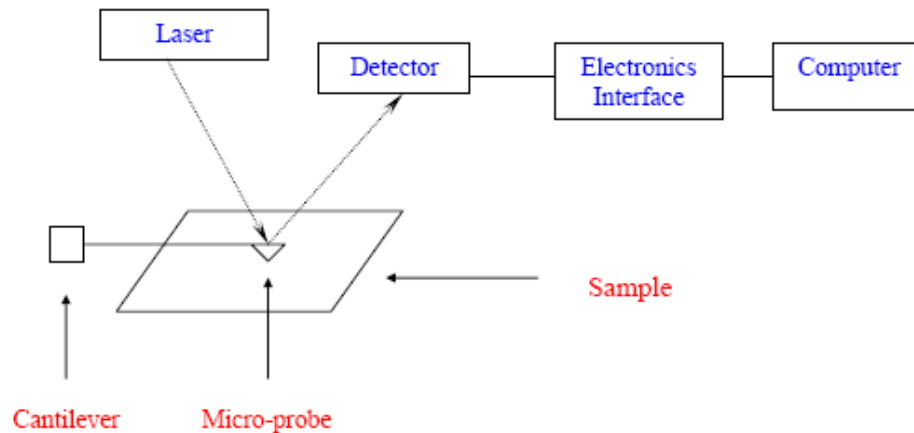
**Fig: 21**

*Applications:* Both STM and AFM find applications widely in material sciences especially for surface studies on a nano scale range. While STM finds its applications in the characterization of surface structure (including the electronic structure), AFM finds its applications in measuring the hardness of materials. Sometimes, AFM can be used in the study of “depth profile” of the deposited oxide layer on to a material.

*Disadvantages:* A limitation to STM is that it can study only the conducting samples, since the technique is based on the tunneling current between two conducting areas. Hence, it doesn't lend itself to the study of non-conducting materials. In fact, the AFM had been developed to encounter this problem. These methods require special sample preparation techniques, which are tedious, like, thin sectioning, electro-polishing, various mechanical cutting and polishing techniques, etc.

## 8. ANALYSIS THROUGH ELECTRO - CHEMICAL TECHNIQUES

Though there are several techniques under this title like Potentiometry, Amperometry, Conductometry, Electrogravimetry, Coulometry, etc., two important techniques are discussed below, which find wide applications.

### 8.1 POLAROGRAPHY

**Principle:** This technique involves the measurement of the current flowing in an electrolysis cell due to the oxidation - reduction reactions (redox reactions) of the analyte substance present in the solution. This redox reaction usually occurs at the surface of one of the electrodes. The current that produced in this way is directly proportional to the concentration of the components under study.

**Instrumentation:** The system comprises of three electrodes:

**Working electrode** - where the oxidation or reduction processes of the analyte of interest occur. It consists of liquid mercury flowing through a very narrow-bore capillary tube and is called “dropping mercury electrode” and abbreviated as DME.

**Reference electrode** - this electrode is silver-silver chloride (Ag/AgCl) type electrode and is crucial for the precise control of the potential of the working electrode.

**Auxillary electrode** - the use of this electrode is to carry the bulk of the current and counters the process that occurs at the working electrode thus making it free from any disturbances except to maintain the redox reaction. Hence, this electrode is also called as “counter electrode”. It is placed in a separate chamber with a fritted glass disc allowing electrical contact with the rest of the cell, but not allowing diffusion of undesirable species to the working electrode.

The sample is placed in a glass container with a medium, which consists of high concentrations of electrolyte. This excess electrolyte helps in bringing down the potential of the electrode process to the desired range and eliminates the interference caused by unwanted complexations and other reactions within the system. This is also referred as “*background electrolyte*”.

**Applications:** It is widely used for the quantitative and qualitative determination of metals and metal complexes as well as organic compounds in trace levels.

**Disadvantages:** The measurements with this technique are very sensitive to solution composition, dissolved oxygen and capillary characteristics. Further, impurities if any, present in the background electrolyte also affect the sensitivity.

### 8.2 ELECTROPHORESIS

**Principle:** This technique is actually a separation process by applying an electric field. The principle is that under the influence of an electric field dissolved ions present in a solution will migrate at varied rates and direction in a column or a surface. At this instance two events take place:

1. *ions of opposite charge will migrate in different directions and become separated.*
2. *ions of like charge while migrating in the same direction, become separated due to different migration rates.*

Factors influencing migration rates are *charge values* and *different mobility*. Further, the mobility of an ion is dependent on the size and shape of the ion, as well as the nature of the medium through which it migrates. The medium used in most of the cases is either cellulose or gel. This technique is sometimes referred as “*Zone or Capillary Electrophoresis*”.

***Instrumentation:*** The materials needed are cellulose or polymeric gel as a supporting medium, enclosed tank with electrodes and buffer reservoirs and dc power supply.

***Applications:*** This technique finds application in the qualitative characterization of biologically active materials, where, charged amino acids and other biomolecules need to be separated. Thus, analysis of protein and nucleic acid using this method becomes very popular.

This is highly useful for clinical and forensic work, where small amounts of complex samples may be involved.

***Disadvantages:*** This technique gives less precision results for quantitative works hence application in this aspect is restricted. Mobility is very sensitive to supporting medium, so selection of the medium is very important.

## 9. ANALYSIS THROUGH MISCELLANEOUS TECHNIQUES

### 9.1 TOTAL ORGANIC CARBON ANALYZER (TOC)

The element carbon is the most common form that can be found everywhere. Its measurement at trace levels is very important, especially, in the fields of Environmental Pollution, Pharmaceuticals, Industrial Effluents, etc., to maintain the threshold limits of the concerned contaminants. Among these, monitoring the organic compounds in the environment is important, since inorganic carbon constitutes to only a lesser extent having its presence with carbonates, bicarbonates and dissolved carbon dioxide. Hence, it is customary to find out the presence of carbon as Total Organic Carbon, which represents the quantity of carbon present in water as organic matter, either dissolved or suspended.

The principle of the TOC is very simple which involves complete oxidation of carbonaceous materials to carbon dioxide and water by catalytic combustion or by chemical oxidation. The released carbon dioxide is measured using an IR detector since this molecule strongly absorbs in the IR region. In cases, wherein the measurement of inorganic carbon is necessitated then it is done within the same instrument by purging air through the sample placed in acid solution. This will create the formation of carbon dioxide and water from the inorganic carbonates and bicarbonates.

### 9.2 ELEMENTAL ANALYZER

This technique determines the presence of the elements like Carbon, Hydrogen, Nitrogen and Sulphur in a given substance and gives the result as percentage amount of these atoms against the total weight. Since this technique specifically determines these four elements this instrument is also called as "*CHN/S Analyzer*". Most of the organic compounds are made up of these four elements and oxygen, hence after determining the former elements percentage weight of oxygen can be easily calculated.

In this technique the substance under study is combusted under oxygen stream in a furnace at high temperatures. The end products of the combustion would be mostly the oxides of the concerned elements in the form of gases. These are then separated and carried to the detector using inert gases like helium or argon.

It is one of the few analytical techniques that give a clear quantitative measurement of the carbon, hydrogen, nitrogen and sulphur. It finds applications in almost every field of chemistry like in the analysis of organics (especially to find out the molecular formula of a newly synthesized compound), polymers, pharmaceuticals, energy (fuels), environmental studies, etc.

### 9.3 POLARIMETRY

**Principle:** In the preceding section under spectroscopy (*Section 3*) interaction of light with the substances leading to absorption, emission and fluorescence has been dealt. Here the phenomena concerns with the rotation of the plane of the *plane polarised light* when it is passed through the samples which lacks symmetry (e.g. sugar), these substances which are asymmetric in nature are said to be optically active substances. A plane polarised light is that which essentially has its vibration in only one direction or one plane as shown below:

**Fig: 22**

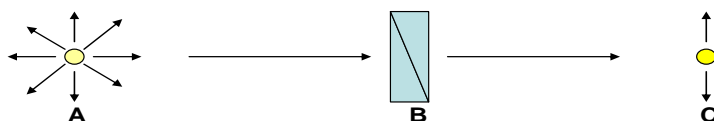

In the above illustration “A” refers to the light waves propagating in all directions or planes (multidirectional), “B” refers to the Nicol prism which cuts all the planes of light and allows the light to come out with vibration in only one plane or direction (unidirectional) and “C” is the resultant light which is said to be a plane polarised light. It is the light, which is utilised for the measurement of the optical activity of a compound. The plane of this light will be rotated to certain extent depending on the nature of the compound under study and forms the basis of this technique.

**Instrumentation:** It comprises of a sodium lamp, nicol polarizer, sample tube, nicol analyzer and an eyepiece.

**Fig: 23**

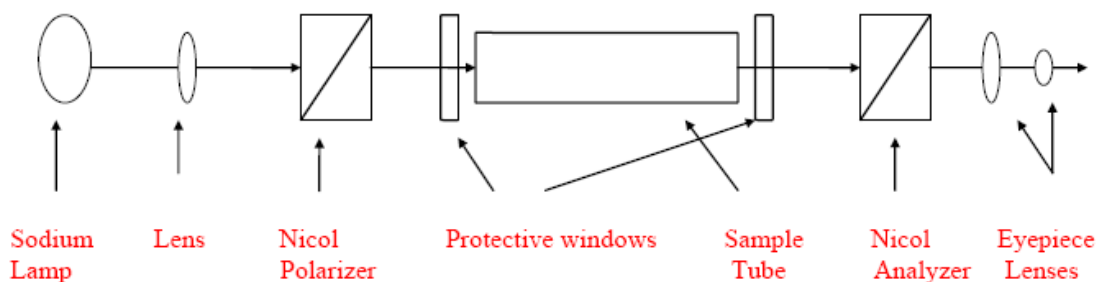

If, the rotation of the plane by a compound is in the clockwise then it is said to be *dextro*, if it is in the anticlockwise then it is said to be *laevo*. For any compound the rotation depends on the concentration and the length of the sample tube and importantly on the temperature too.

**Applications:** It is mainly used as a quantitative tool. It finds extensive application in the analysis of sugar. In pharmaceutical industry it is used for the measurement of concentration of optically active drugs.



**Disadvantages:** It requires the samples only in solution form. The sample tube, after filling with the sample solution, should be free of bubble or any free particle, otherwise the light path will be affected and hence the accuracy. The sample holder should be thermostatted, since the optical activities of the substances vary with temperature.

#### 9.4 UV/VISIBLE SPECTROPOLARIMETRY

**Principle:** In the preceded section the rotation of the plane of the polarized light by optically active compounds has been discussed. In practice, it is produced by combining two plane-polarized light waves of identical frequency moving through the same region of the space in the same direction, to produce a resultant wave, which is also linearly polarized. If these two waves of identical amplitude are orthogonal, combining them can lead to linearly polarized or circularly polarized light depending on the phase difference between the two waves.

##### **Optical Rotatory Dispersion (ORD):**

In polarimetry, the rotation of the plane of linearly polarized light (two combined plane-polarized waves with no phase difference) by optically active substances is studied **at a fixed wavelength**. In spectropolarimetry it is studied over **a range of wavelength** whereby the dependence of the rotation on the selected wavelength range is measured and is termed as Optical Rotatory Dispersion. The instrumentation is similar to a polarimeter except for a tunable wavelength source. ORD measures the **differences in refraction of the polarized light waves** through the sample resulting in a rotation of the plane.

**Circular Dichroism (CD):** If the two plane-polarized orthogonal light waves are  $90^0$  out of phase then the resultant gives a circularly polarized light. It can either be *right circularly polarized (d-component)* or *left circularly polarized (l-component)* depending on the direction of the phase shifting. If these two oppositely polarized circular waves are combined the resultant would be a linearly plane-polarized light. CD measures the **differences in absorbance of the polarized light waves** by the sample resulting in an ellipticity, when the two circularly polarized light waves are combined after passing through the sample (Fig: 24a).

**Linear Dichroism (LD):** The linearly polarized light can either be made parallel or perpendicular to the orientation axis using a polarizer and, if this is passed through the sample it will give the information regarding the orientation of the molecules present in the sample. LD measures the **differences in absorbance of the linearly polarized light waves** (Fig: 24b).

**Fig: 24a**

**Case 1:** When there is no absorption by the sample:

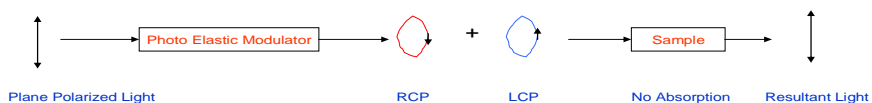

**Case 2:** When there is an absorption by the sample:

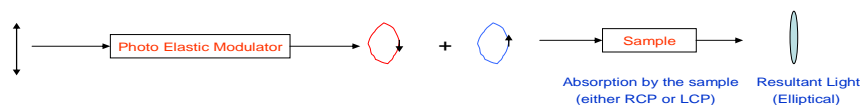
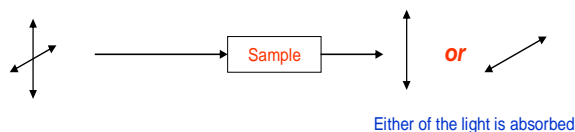
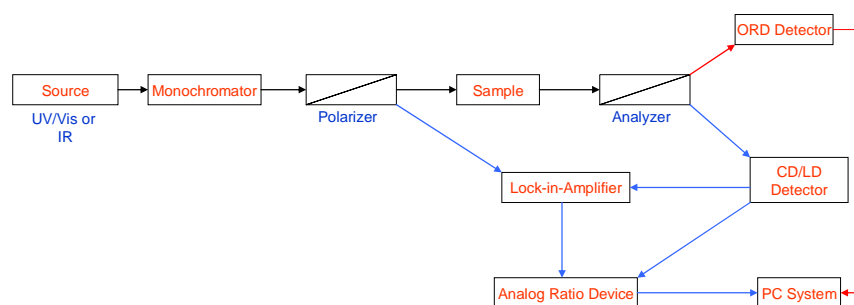

Fig: 24b



**Instrumentation:** Normally the instrumentation of a spectropolarimeter is so designed to accommodate both the functions of ORD and CD. It consists of a source (covering UV to visible), monochromator, polarizer, analyzer, detectors, lock-in amplifier, display device, etc.

Fig: 24c



**Applications:** Both CD and ORD measurements are employed in fundamental studies to provide structural information in the area of stereochemistry and conformation about optically active compounds like, amino acids, proteins, etc. LD measurement is mostly employed to study the molecular orientations in the stretched polymer films.

**Disadvantages:** Only optically active compounds and surface oriented thin films can be analyzed.

## 9.5 VIBRATIONAL CIRCULAR/LINEAR DICHROISM (VCD/VLD)

**Principles:** The phenomenon of CD and LD if occurs in the Infrared region which corresponds to the vibrational frequencies of the molecules then the techniques are termed as Vibrational Circular Dichroism (VCD) and Vibrational Linear Dichroism (VLD).

**Instrumentation:** VCD spectrometer is constructed using the same detection scheme as described for the UV/Vis CD spectrometer described above, except for the optical components suitable for infrared region. Thus normally a VCD accessory is combined with a FT-IR spectrometer.

## 9.6 MASS SPECTROMETRY

**Principle:** In this technique chemical substances are bombarded with high energy electron beam causing total destruction and fragmentation of the molecules in the sample. This fragmentation results in small charged “pieces” or fragments of the molecules, which, because of their charge are made to move through a magnetic field. The magnetic field

affects each fragments differently based on their *mass* and *charge* that they carry and thus they are separated.

**Instrumentation:** It consists of a source of high-energy electrons, ion accelerator, magnets, detector, recorder and high vacuum pumping system. In the instrumentation the entire path of the fragments, including the inlet system must be evacuated. The reason is to avoid collisions of both the electron beam and the sample ions with contaminating foreign particles which would otherwise affect the sensitivity and hence the results. For this technique there are two different instrument designs as Magnetic Sector Mass Spectrometer and Quadrupole Mass Spectrometer. The former is the older version which uses strong magnets to focus the fragmented ions to the detector plate, whereas, the latter uses four short parallel metal rods; wherein two vertical rods are connected to the positive pole and the other two to the negative pole of a variable power source. This will create a variable electric field and is used to focus the fragments on to the detector slit. This quadrupole instrument is newer and more popular because of its compact design and also it provides a faster scanning capability. The following is the illustration for the **quadrupole mass spectrometer**:

**Fig: 25**

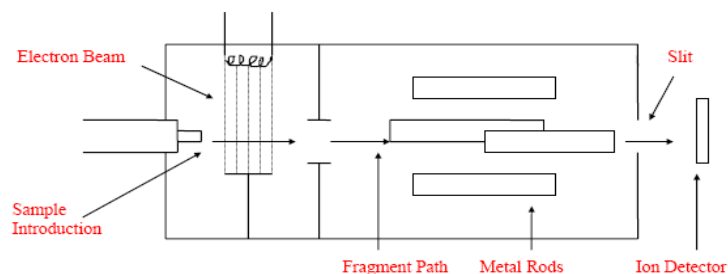

**Applications:** It is widely used in conjunction with IR, UV and NMR in the identification and structural analysis of organic compounds. It is also possible to determine the trace impurities in a wide range of inorganic materials. It is well suited for gas analysis and is used by the petroleum industry for both the qualitative and quantitative analysis of hydrocarbon distillates and other petrochemicals. It is invaluable in the analysis of both terrestrial and extra-terrestrial atmospheres, the latter being achieved by instruments with light-weight components. The mass spectrometer has been used as a detector in gas chromatography (GC-MS), in liquid chromatography (HPLC-MS), in thermogravimetry (TGA-MS) and in inductively coupled plasma spectrometry (ICP-MS).

**Disadvantages:** The instrumentation is complex and difficult to maintain.

## 9.7 LASER LIGHT SCATTERING SYSTEM

When light (usually a laser beam) is shined or focused on a solution containing the macromolecule of interest (polymers, proteins, etc.), it will scatter and provide the information about molecular structure and motion in the solution.

**Principle:** Interaction of light (electro-magnetic radiation) with matter results in two processes, viz. absorption (which forms the basis of spectroscopy) and scattering. When a beam of light falls upon a matter, the electric field associated with the light polarizes the electron cloud of the atoms. Thus a dipole is induced in the molecules, which oscillates with the electric field. These oscillating electron clouds then serve as secondary sources of light

and emit light in various directions (scattering). The scattered light has almost the same wave length as the incident light (also referred as *Elastic Scattering* or *Rayleigh Scattering*) and merely redirected from the incident beam. It is the intensity of the scattered light and its angular distribution which give the information regarding the nature of the molecules under study.

*Instrumentation:* It consists of a laser source, thermostatted sample holder, movable photo diode detector, correlator, etc.

**Fig: 26**

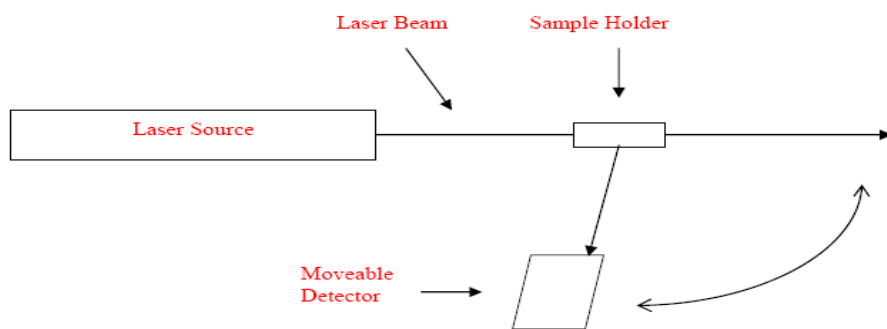

*Applications:* Usually the instrument operates at two modes viz. *Static Light Scattering* mode and *Dynamic Light Scattering* mode.

*Static Light Scattering* – this mode measures the intensity and angular dependence of the scattered light (i.e. Elastic or Rayleigh scattering), which gives the information on molecular mass, radius of gyration and second virial coefficient (interaction of solvents with the substances under study). Thus it is helpful in characterizing macromolecules and their associations.

*Dynamic Light Scattering* – this mode measures the fluctuations in the intensity of the scattered light caused by the continuous motion of the particle (Brownian motion). Continuous movement of particles in the medium will cause the frequency of the scattering light to change (Doppler shift) which is referred as *Quasi-Elastic Light Scattering (QELS)* and the technique *Photon Correlation Spectroscopy*. The measurement gives the information on the translational diffusion coefficient and the polydispersity of the sample, which are useful in determining the macromolecule size and their aggregations.

## 10. SUMMARY

The following is the summary of the foregone descriptions:

<b>TECHNIQUES</b>	<b>APPLICATIONS</b>
<b>SPECTROSCOPY</b>	
Atomic Absorption and Emission Spectroscopy ( <b>AAS/AES</b> )	To analyse alkali and alkaline earth metals in dilute solution, natural liquids, and extracts at trace levels
Ultraviolet-Visible Spectroscopy ( <b>UV/Vis</b> )	To analyse molecular (organic) and ionic species capable of absorbing at UV or Visible wavelengths in dilute solutions
Fourier Transform Infrared Spectroscopy ( <b>FT-IR</b> )	To analyse only molecular compounds (organic compounds, natural products, polymers, etc.)
Fourier Transform Raman Spectroscopy ( <b>FT-Raman</b> )	To analyse molecular (organic) compounds which are not responding well in the IR region and hence, it is an alternate to IR
Nuclear Magnetic Resonance Spectroscopy ( <b>NMR</b> )	To identify and characterize the organic and inorganic compounds
Microwave Spectroscopy	To analyse simple gaseous molecules in Far IR region, to study their stereo chemistry
Electron Spin Resonance Spectroscopy ( <b>ESR</b> )	To study the formation and life time of the free radicals formed in organic reactions and also finds applications in biological works
Molecular Fluorescence Spectroscopy	To study the molecular and ionic compounds in dilute solutions capable of giving fluorescence, finds applications in vitamin analyses
<b>CHROMATOGRAPHY</b>	
High Performance Liquid Chromatography ( <b>HPLC</b> )	To separate and analyse complex mixtures or solutions which include liquids and solids of both organic and inorganic origins
Gas Chromatography ( <b>GC</b> )	To separate and analyse mixtures of volatile organic compounds, solvent extracts and gases
<b>THERMAL ANALYSIS</b>	
Thermogravimetric Analysis ( <b>TGA</b> )	To study the mass changes of materials like polymers, glasses, ceramics, etc., such as evaporation, decomposition, gas absorption, de-sorption, dehydration, etc.
Thermomechanical Analysis ( <b>TMA</b> )	To study the expansion coefficient of composite and laminate materials
Differential Thermal Analysis ( <b>DTA</b> )	To study the exothermic and endothermic behaviour of clay materials, ceramics, ores, etc.
Differential Scanning Calorimetry ( <b>DSC</b> )	To study the glass transition temperature, curing process of the thermoset polymers and heat of melting of thermoplastic polymers.

<b>X-RAY TECHNIQUES</b>	
X-Ray Fluorescence ( <b>XRF</b> ) Spectrometry and X-Ray Photo-emission Spectrometry ( <b>XPS</b> )	To identify the elements and their valence states present in the surface of the materials
X-Ray Diffractometry ( <b>XRD</b> )	To study the crystalline properties of solid substances
<b>MICROSCOPY</b>	
Scanning Electron Microscopy ( <b>SEM</b> )	To study the topography, electronic structure and compositions of metals, ceramics, polymers, composites and biological materials
Transmission Electron Microscopy ( <b>TEM</b> )	To study the local structures, morphology, and dispersion of multicomponent polymers, cross sections and crystallizations of metallic alloys, semiconductors, microstructure of composites, etc.
Scanning Probe Microscopy ( <b>SPM</b> )	To study the hardness and topography of materials like ceramics, polymers, composites, etc., on a nano-scale range
<b>ELECTRO-CHEMICAL TECHNIQUES</b>	
Polarography	To study and determine metals, metal complexes and organic compounds in trace levels
Capillary Electrophoresis ( <b>CE</b> )	To study and characterize biologically active compounds like proteins, amino acids and other bio-molecules
<b>MISCELLANEOUS TECHNIQUES</b>	
Total Organic Carbon Analyzer ( <b>TOC</b> )	To monitor pollutants in environmental studies by determining the carbon contents of the trace compounds
Elemental Analyzer ( <b>CHN/S</b> )	To estimate percentage compositions of elements like carbon, hydrogen, nitrogen and sulphur present in newly synthesised organic compounds, pharmaceuticals, etc.
Polarimetry	To analyse and quantitate optically active compounds like sugar
UV/Visible Spectropolarimetry (Circular Dichroism ( <b>CD</b> ) and Optical Rotatory Dispersion ( <b>ORD</b> ))	To get the structural information of optically active compounds like, amino acids, proteins, etc.
Vibrational Circular Dichroism ( <b>VCD</b> ) and Vibrational Linear Dichroism ( <b>VLD</b> )	Same as above but in the IR region. VLD measurement is employed to study the molecular orientations of thin polymer films
Mass Spectrometry ( <b>MS</b> )	To identify the organic compounds. Often used as detectors with HPLC and GC
Laser Light Scattering System ( <b>LLIS</b> )	In the study of macromolecules like polymers, gels, proteins, etc., for determining molecular mass & size and their associations

## 11. REFERENCE

1. G. W. Ewing, *Instrumental Methods of Chemical Analysis*, 5<sup>th</sup> Edition, McGraw-Hill, New York, 1985.
  2. J. Kenkel, *Analytical Chemistry - Refresher Manual*, Lewis Publishers, Boca Raton, 1992.
  3. D. A. Skoog, F. J. Holler and T. A. Nieman, *Principles of Instrumental Analysis*, 5<sup>th</sup> Edition, Thomson Learning, Crawfordsville, 1998.
  4. F.W. Fifield and D. Kealey, *Principles and Practice of Analytical Chemistry*, 5<sup>th</sup> Edition, Blackwell Science, Malden, 2000.
  5. J. W. Robinson, Eileen M. S. Frame, and G. M. Frame II, *Undergraduate Instrumental Analysis*, 6<sup>th</sup> Edition, Marcel Dekker, New York, 2005.
  6. J. D. Ingle and S. R. Crouch, *Spectrochemical Analysis*, Prentice-Hall Int., New Jersey, 1988.
  7. N. B. Colthup, L. H. Daly and S. E. Wiberley, *Introduction to Infrared and Raman Spectroscopy*, 3<sup>rd</sup> Edition, Academic Press, Boston, 1990.
  8. J. P. Sibilias, *Materials Characterization and Chemical Analysis*, Second Edition, VCH Publishers, New York, 1988.
  9. B. G. Yacobi, D. B. Holt and L. L. Kazmerski, *Microanalysis of Solids*, Plenum Press, New York, 1994.
  10. T. Kuwana, *Physical Methods in Modern Chemical Analysis*, Volume 2, Academic Press, London, 1980.
  11. J. F. Rabek, *Experimental Methods in Polymer Chemistry*, John Wiley and Sons Ltd, Chichester, 1980.
  12. E. Schroder, G. Muller and K. F. Arndt, *Polymer Characterization*, Hanser Publishers, Munich, 1989.
  13. H. G. Brittain, *Chiroptical Techniques in Analytical Instrumentation Handbook*, Editor: G. W. Ewing, 2<sup>nd</sup> Edition, Marcel Dekker, New York, 1997.
  14. A. Rodger and B. Norden, *Circular Dichroism and Linear Dichroism*, Oxford University Press, Oxford, 1997.
-

## Course 452Ch: Coordination Compounds (Part II)

**Prof. Dr. Usama Mohamed Rabie,**

*The content of this course have been collected and summarized  
from the Text Books mentioned at the end*

### I- The Valence Bond Theory (VBT):

In the thirties of the past century, Linus Pauling elaborated the valence bond theory, which has given important impetus to advances in coordination chemistry. Today, this theory is primarily of historical interest since it has been superseded by more advanced propositions. Yet the main advantage of Pauling's theory in its simplified version remains its high illustrative value, which makes it an ideal introduction to complex compounds.

According to the **VBT**, every ligand is a *donor of electrons*. Its electron pairs are transformed to the *vacant orbitals of the central metal ion*. When the ligand donate its pairs of electron to the vacant orbitals of the central metal ion (or atom), the vacant orbitals are *oriented to be equivalent* and to form symmetrical complex structure. For octahedral complex, the vacant orbitals are oriented toward the vertices of the octahedron, but for tetrahedral complex they are directed toward the vertices of the tetrahedron, and if the complex is a planner square, the vacant orbitals are oriented toward the corners of the square. The orientation of these vacant orbitals are occurred





Indeed, the number of empty energy boxes at the electron sublevels  $3d$ ,  $4s$ , and  $4p$  in the bond diagram corresponds exactly to what is needed to form an octahedral complex (*hybridization of the  $d^2sp^3$  type*). Since the *number of lone-pair electrons does not change* in  $\text{Cr}^{3+}$  during complex formation, such a complex ( $[\text{Cr}(\text{NH}_3)_6]^{3+}$ ) is referred to as spin-free or high-spin:

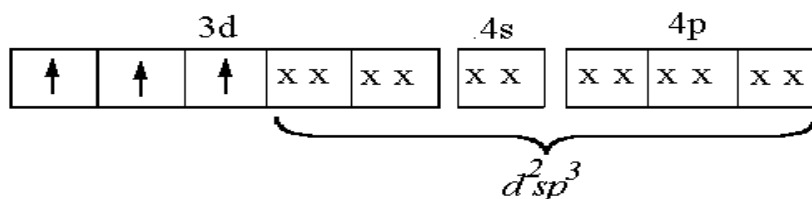

(Whereas the arrows in the energy boxes represent electrons of the central metal ion, the crosses represent the electrons of the donor atoms of nitrogen).

(b)  $[\text{Co}(\text{NH}_3)_6]^{3+}$  is a representative example of the outer-orbital complexes of the spin – paired (low spin) type:

(At.N. of Co = 27), and the electron configuration of the  $\text{Co}^{3+}$ , ( $d^6$ ) is:

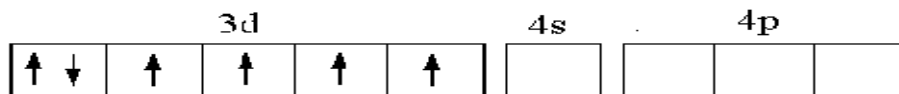

For octahedral ( $d^2sp^3$ ) distribution of six ligands ( $\text{Co}^{3+}$  coordinates with six nitrogen atoms of the ammonia molecules) to occur in the complex  $[\text{Co}(\text{NH}_3)_6]^{3+}$ , it is necessary to *empty* two energy boxes at the  $3d$  sublevel of the  $\text{Co}^{3+}$  ion. This can be achieved in two ways: (1) by “urging” two electrons from the  $3d$  sublevel to move up to energetically higher-lying

orbitals, such as  $4d$  or  $5s$ , or (2) by *pairing electrons* at the  $3d$  sublevel. The second alternative is energetically more favorable.

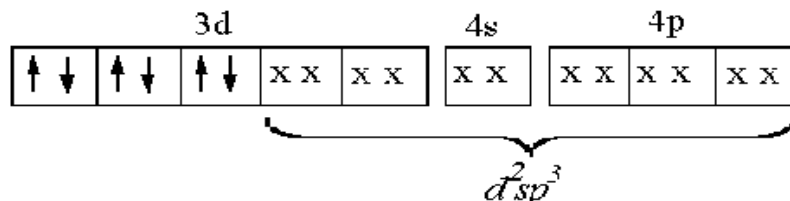

So the electrons coming from the donor will occupy the three vacant orbitals (of  $4s$  and  $4p$  sublevels) and two *vacated* orbitals of the  $3d$  sublevel. Hence, the *number of lone-pair electrons changes* in  $\text{Co}^{3+}$  during complex formation, such a complex ( $[\text{Co}(\text{NH}_3)_6]^{3+}$ ) is referred to as spin-paired or low-spin.

**ii- Outer-orbital complexes:**

In the outer-orbital complexes, the electron pairs of the ligand occupy the *vacant outer orbitals* of the complexing ion; that are of the lower energy. Thus, outer-orbital complexes are, *as a rule*, spin – free, high spin, that is no change of the lone pair electrons in the inner-orbitals of  $\text{Co}^{3+}$  beside no vacation of electrons are occurred, and in turn they are *paramagnetic*.

The outer-orbital complexes are simplified by  $[\text{CoF}_6]^{3-}$  complex. So according to the **VBT**, its structure may be represented schematically as follows:

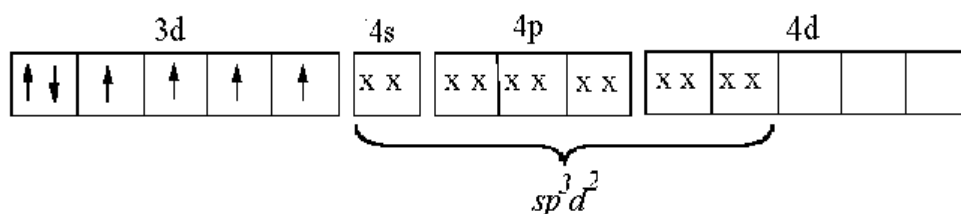

### ***Limitations of the VBT:***

Even after the concepts of the outer- and inner-orbital complexes have been introduced, the VBT could not explain many of the aspects having to do with their structures and properties. (1) The VBT fails to account for the absorption spectra of complex compounds because it does not take into account the possible occurrence of excited states, and (2) The VBT concerned only with the formation of  $\sigma$ -bonding complexes.

## **II- The Crystal Field Theory (CFT):**

The crystal field theory (**CFT**) was formulated in 1929 by Hans Bethe, and since the fifties it has been used in coordination chemistry as one of the theories giving an insight into some structural features of complex compounds, more specifically the origin of their absorption spectra.

Unlike the VBT, the crystal field theory ignores the concepts of orbital hybridization and donor – acceptor bonding.

It deals with the spatial distribution of the *d* (or *f*) orbitals of the central ion and takes into account the electrostatic repulsion of these electron-carrying orbitals from the ligands.

Ligands are treated as *negative point charges* or *dipoles* so distributed in space that the energy of mutual repulsion of these charges is *minimal*. This condition is met if the ligands are located at the *vertices* of the octahedron (when the coordination number of the central ion is 6) or at those of the tetrahedron (when the coordination number is 4).

The CFT is based on the principle of taking into account the *electrostatic repulsion* of the electrons of the ligand and central ion. So that, it is assumed that the orbitals of the central ion in a complex are repulsed from the point charges of the ligand and, therefore, tend to occupy such a position in space that their interaction is minimal. This is quite opposite to the VBT which it implied that complexing takes place when the orbitals of the ligand and

central metal ion are directed toward each other and overlap forming  $\sigma$ -bonds. (N.B, Covalent forces are not taken into consideration).

According to the CFT, the “free” ion – that is, the ion in the ground state – of the transition metal, such as the first element of a long period, has its  $3d$  electrons arranged at random at the five available  $d$  orbitals ( $d_{xy}$ ,  $d_{xz}$ ,  $d_{yz}$ ,  $d_{z^2}$ ,  $d_{x^2-y^2}$ ) (of course, Hund’s rule and Pauli’s principle are complied with). In this case, none of the  $d$  orbitals is preferable, all of them being equivalent from the energy standpoint. Such orbitals are known as *degenerate*.

The electrons coming from the ligands are located, as posited by the CFT, at the vertices of the tetrahedron or octahedron (sometimes square) in accordance with the minimal electrostatic interaction principle. In this case, the electrons of the central metal ion tend to occupy those orbitals that are the farthest from the portions of the sphere where the charge of the ligands is concentrated. That is, not all of the  $d$  orbitals are equivalent: *removal of degeneracy*.

It is assumed that the  $d_{x^2-y^2}$  and  $d_{z^2}$  orbitals of the metal ion coincide in direction with the axes of the octahedron whose vertices accommodate the ligands. It is then become evident that the electron clouds corresponding to the  $d_{xy}$ ,  $d_{xz}$ , and  $d_{yz}$  orbitals will find themselves between the axes of the octahedron and, therefore, their electrostatic repulsion from the ligands will be much weaker than that of the electron clouds at  $d_{x^2-y^2}$  and  $d_{z^2}$  orbitals because the latter are directed straight toward the ligands.

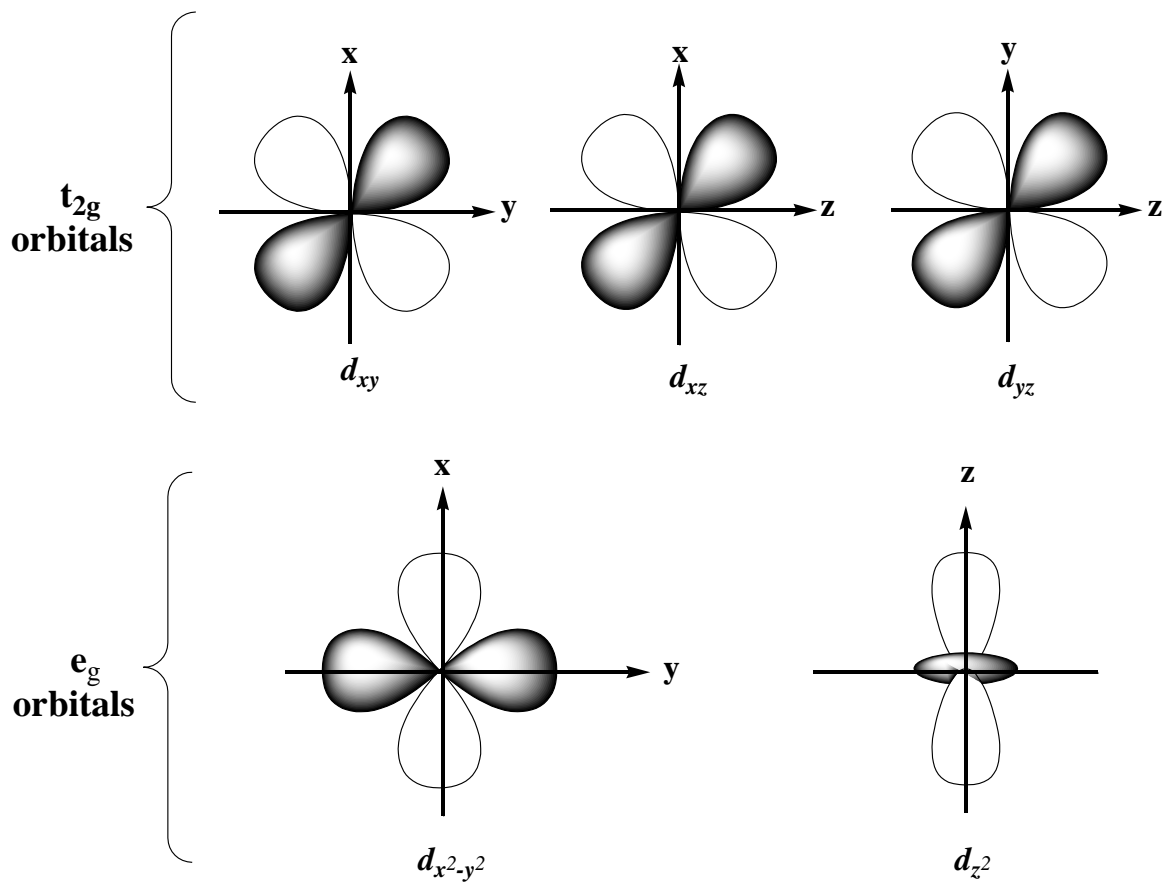

### **$d$ Orbitals**

The opposite is true as regards a tetrahedral complex. In this case, coinciding in direction toward the ligands are the axes of the  $d_{xy}$ ,  $d_{xz}$ , and  $d_{yz}$  orbitals, and in the weakest interaction with the ligands are the electrons that are at the  $d_{x^2-y^2}$  and  $d_{z^2}$  orbitals. According to the CFT, it is these two orbitals that should preferably be occupied by electrons.

Thus, the  $d$  orbitals of the central metal ion in the octahedral and tetrahedral field of the ligands are *not equivalent energetically*. This means that degeneracy is removed from these orbitals, which can be shown schematically as follows:



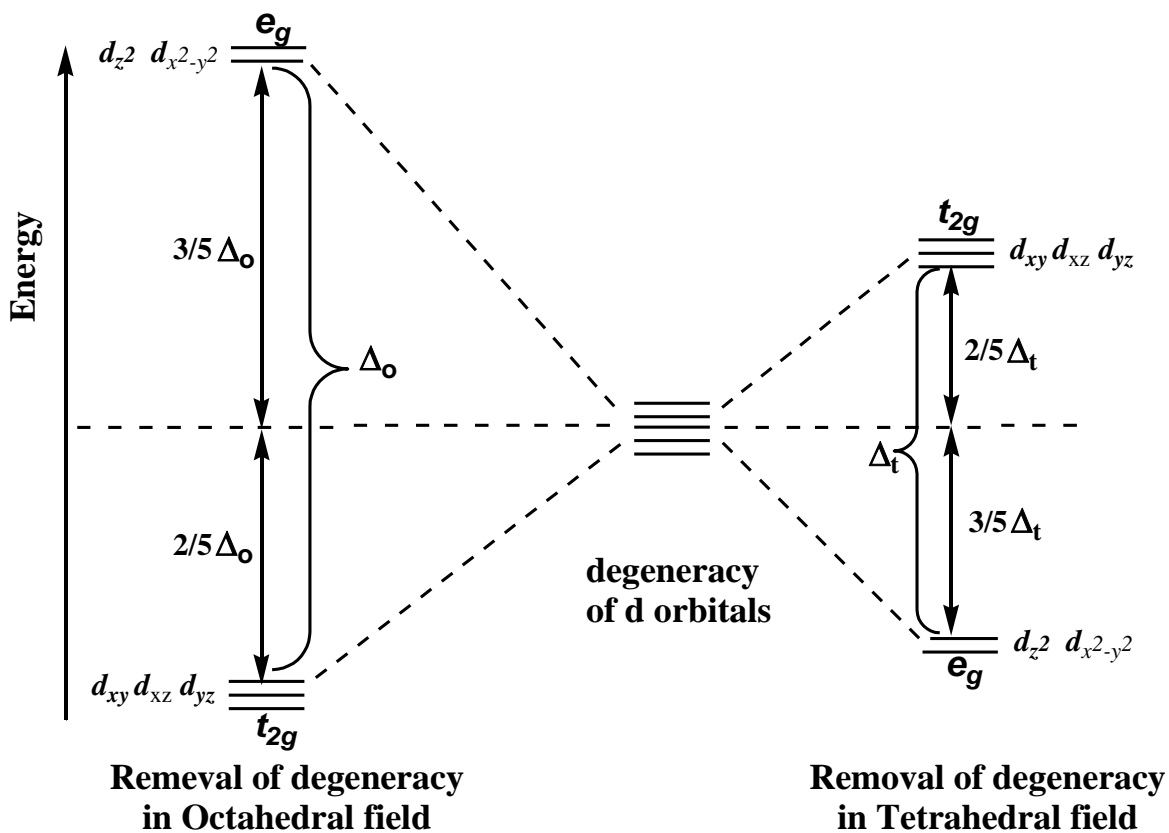

( $\Delta_o$  and  $\Delta_t$  are the energy of splitting for octahedral and tetrahedral complexes respectively)

The three energetically favorable  $d$  orbitals of the metal ion in the octahedral complex are designated  $t_{2g}$ , and the two energetically unfavorable ones are  $e_g$  orbitals. Quite the opposite, in the tetrahedral complex, energetically more favorable are the two  $e_g$  orbitals, while the three  $t_{2g}$  orbitals have a higher energy and, consequently, are not favorable for filling with electrons.

The difference in the energies of the  $e_g$  and  $t_{2g}$  orbitals is denoted by  $\Delta$  and is called splitting. In the octahedral complex (splitting  $\Delta_o$ ), the energy

level  $e_g$  for each electron is  $3/5 \Delta_0$  higher, and the  $t_{2g}$  level is  $2/5 \Delta_0$  lower, than the ground level of the degenerate unsplit orbitals.

In the tetrahedral complex the reverse is true: the  $t_{2g}$  level for each electron is  $2/5 \Delta_t$  higher, and the  $e_g$  level is  $3/5 \Delta_t$  lower, than the ground level of the degenerate unsplit orbitals.

Note that, when all the five  $d$  orbitals the octahedral or the tetrahedral complex are completely filled with electrons, the total energy of the system; either octahedral or tetrahedral complex, equals to *zero*. Also, the energy center of gravity of the system remains the same, when compared to that of the degenerate state, i.e.:

***For octahedral:***

**10** electrons fill the  $d$  orbitals; **4** electrons in the  $e_g$  level and **6** electrons in the  $t_{2g}$  level. *So that:*

$$e_g^4 \Rightarrow 3/5 \Delta_0 \times 4 = 12/5 \Delta_0$$

$$t_{2g}^6 \Rightarrow 2/5 \Delta_0 \times 6 = 12/5 \Delta_0$$

$$\text{The energy of the system} = 12/5 \Delta_0 + (-12/5 \Delta_0) = 0$$

***For tetrahedral:***

**10** electrons fill the  $d$  orbitals; **4** electrons in the  $e_g$  level and **6** electrons in the  $t_{2g}$  level. *So that:*

$$t_{2g}^6 \Rightarrow 2/5 \Delta_t \times 6 = 12/5 \Delta_t$$

$$e_g^4 \Rightarrow 3/5 \Delta_t \times 4 = 12/5 \Delta_t$$

$$\text{The energy of the system} = 12/5 \Delta_t + (-12/5 \Delta_t) = 0$$

N.B,  $d^0$ ,  $d^5$ , and  $d^{10}$  lead to zero result of the energy of splitting.

Two factors control pairing of the electrons or in general the electron distribution through the  $d$  orbitals. These two factors are (1) the energy of splitting,  $\Delta$ , ( $\Delta_0$  for octahedral or  $\Delta_t$  for tetrahedral), and (2) the energy expenditures ( $P$ ) involved in (required for) pairing of electrons.

Whereas the energy of splitting is caused mainly by the ligand, the central metal has the main role in responsibility for the energy of expenditure ( $P$ ). So that, the ratio between  $P$  and  $\Delta$  depends both on the metal ion species and on the nature of the ligand.

The ratio between  $P$  and  $\Delta$  determines the magnetic properties of the formed complexes whether they are of low – spin (spin paired) or of high – spin (spin free).

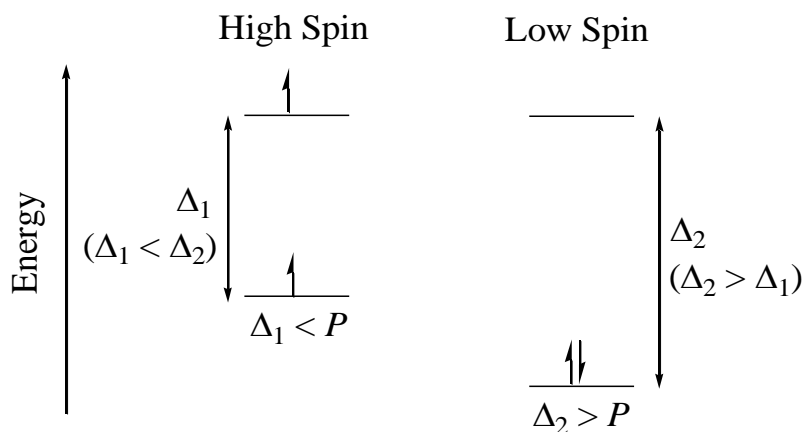

Dependence of high and low spin configurations on extent of orbital splitting ( $\Delta_1$ ) and electron pairing energy  $P$  for a simple two-orbital system.

Thus, when  $P > \Delta$ , the formed complex will be of high – spin (spin free), and when  $P < \Delta$ , the complex will be of low – spin (spin paired).

That is, the configurations with the maximum possible number of unpaired electrons (when  $P > \Delta$ ) are called the high-spin (spin free) configuration, and those with the minimum number of unpaired spins (when  $P < \Delta$ ) are called the low-spin (spin-paired) configurations.

With respect to the values of the pairing energy  $P$ ,  $P$  is very high for the  $\text{Mn}^{2+}$  and  $\text{Fe}^{3+}$  ions with electron configuration  $d^5$  ( $P = 25\,000$  to  $30\,000\text{ cm}^{-1}$ ) (At. No. of  $\text{Mn}^{2+}$  and  $\text{Fe}^{3+}$  is 23). This is explained by especially high stability of the half-filled  $d$  sublevel at  $d^5$  configuration. So that, ions of  $d^5$  configuration form predominantly high-spin (spin free) complexes.

In the case of  $d^6$  configuration ( $\text{Fe}^{2+}$  and  $\text{Co}^{3+}$ ),  $P$  is much lower ( $17\,000\text{ cm}^{-1}$ ). (At. No. of  $\text{Fe}^{2+}$  and  $\text{Co}^{3+}$  is 24). So that, ions of electron configuration  $d^6$  form predominantly low-spin (spin paired) complexes.

(Since the splitting energy is related with the positions of absorption bands, as it will be discussed later, it is convenient and common practice to use the same unit; the reciprocal centimeter or wave number, abbreviated  $\text{cm}^{-1}$ , for the unit of frequency in the spectra and the unit of the energy for the orbitals. N.B.:  $1\text{ KJ mol}^{-1} = 83.7\text{ cm}^{-1}$ ).

The amount of splitting  $\Delta_o$  (the splitting energy in octahedral complexes is taken here for explanation) is greater for complexes of the triple-charged

ions of  $3d$ -transition elements (usually 14 000 to 25 000  $\text{cm}^{-1}$ ), as opposed to the double-charged ions (7 500 to 12 500  $\text{cm}^{-1}$ ). This is due to the stronger electrostatic repulsion of the orbitals from the ligands in the case of triple-charged central ions than that in the case of the double-charged central ions.

In general, in the series of  $3d$ -,  $4d$ -, and  $5d$ -transition metals, when all other conditions being equal,  $\Delta_o$  increases from one period to another by 30 to 35 per cent. For example:

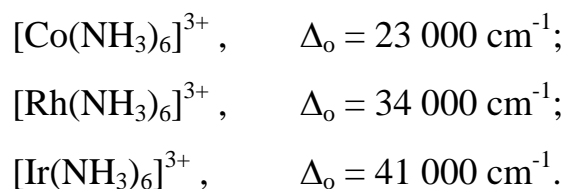

A possible explanation is that the  $d$  orbitals grow in special extent and their repulsion from the ligand becomes stronger with increasing atomic number of the element constituting the central ion.

It should be taken into account that in tetrahedral complexes splitting (repulsion of orbitals) is less pronounced in octahedral ones:

$$\Delta_t \approx 4/9 \Delta_o .$$

Therefore, the probability of  $P < \Delta$  is lower in the tetrahedral complexes, and so tetrahedral complexes are more often of the high-spin (spin free) type, as opposed to the octahedral ones.

The effect of the ligand species on the ratio between  $P$  and  $\Delta$  is also of great importance for a given metal ion.

For instance, in the case of  $\text{Fe}^{2+}$  (configuration  $d^6$ ) with pairing energy  $P = 17\,600\text{ cm}^{-1}$ , the splitting energy varies in the following two octahedral complexes:

$$[\text{Fe}(\text{H}_2\text{O})_6]^{2+} \text{ has } \Delta_o = 10\,400\text{ cm}^{-1},$$

$$[\text{Fe}(\text{CN})_6]^{4-} \text{ has } \Delta_o = 33\,000\text{ cm}^{-1}.$$

In the former case, aquo complex,  $P > \Delta_o$ , so that the complex is of high-spin (spin free). But in the second case, cyano complex,  $P < \Delta_o$ , so that the complex has the low-spin (spin paired) magnetic property.

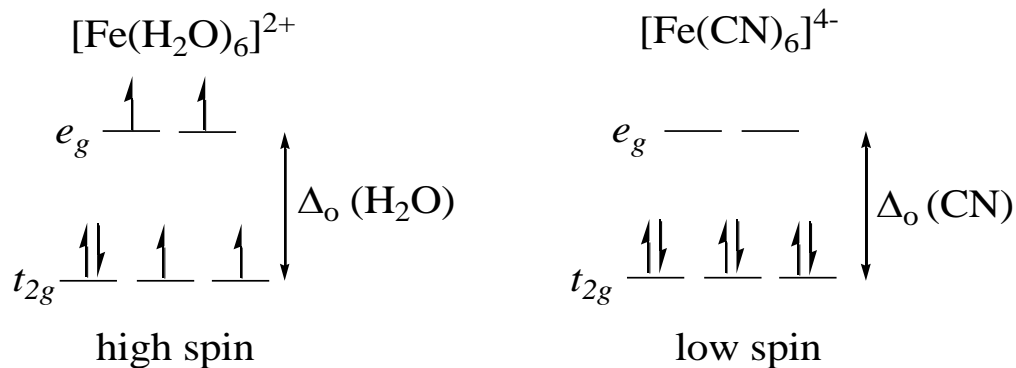

Electron configuration for  $\text{Fe}^{2+}$  in an octahedral complex

In accordance with the amount of splitting in octahedral complexes, ligands form the following so-called *spectrochemical* series:

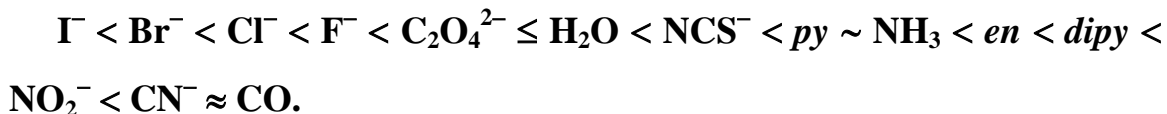

This order of increasing  $\Delta_o$  is usually, but not always, observed for most central complexing ions.

Two groups are distinguished according to the amount of splitting in octahedral complexes: *weak*- and *strong*-field ligands.

In the above spectrochemical series, the ligands to the *left* of  $\text{NH}_3$  usually form *weak field* (high-spin, or spin free, complexes), and those to the *right* form *strong field* (low-spin, or spin paired, complexes).

Depending on the electron *structure of the central ion* and the *position of the ligand in the spectrochemical series*, complexing results in a certain gain in energy, which is known as the **Energy of Stabilization by the Crystal Field (ESCF)**.

Stabilization by the crystal field (of the ligand) is attained as a result of distribution of the central atom electrons primarily among the lower energy sublevels of a given level split under the effect of the ligand field of a particular symmetry.

The gain in energy (ESCF) is maximum if the  $t_{2g}$  sublevel is fully occupied by electrons (strong field, configuration  ${}^6t_{2g}$ ), while the  $e_g$  sublevel remains vacant. (splitting energy =  $6 \times 2/5\Delta_o = 12/5\Delta_o$ )

On the other hand, the ESCF is zero if both  $t_{2g}$  and  $e_g$  sublevels are filled completely,  $d^{10}$ , (for both strong and weak fields). When electrons occupy both  $t_{2g}$  and  $e_g$  levels, electron configuration  ${}^6t_{2g} {}^4e_g$  is achieved. So that a compensation of the energy between the two  $d$ -sublevels ( $t_{2g}$  and  $e_g$ ) and the net result will be zero:

$$\text{Energy of } {}^6t_{2g} = 6 \times 2/5\Delta_o = 12/5\Delta_o$$

$$\text{Energy of } {}^4e_g = 4 \times 3/5\Delta_o = 12/5\Delta_o$$

$$\text{The total energy (ESCF)} = 12/5\Delta_o + (-12/5\Delta_o) = 0$$

Also, ESCF equals zero for the high spin octahedral complexes (weak field) whose central atom has the electron configuration  $d^5$  (or  ${}^3t_{2g} {}^2e_g$ ):

$$\text{ESCF} = 3 \times 2/5\Delta_o + (-2 \times 3/5\Delta_o) = 0$$

### **Examples:**

#### ***For high-spin (spin free) complexes***

The highest value of the ESCF is attained for  $\text{Cr}^{3+}$ , that is of  $d^3$  electron configuration. Electrons will occupy the  $t_{2g}$  sublevel only, i.e.  ${}^3t_{2g}$ . So that, ESCF being equals to  $3 \times 2/5\Delta_o = 6/5\Delta_o$ , which is a very high value.



If the number of electrons at the  $d$  level of the central ion is increased or decreased, for example in going to high-spin complex with configuration  $d^4 = {}^3t_{2g}^1 e_g$ , the ESCF will be lowered:

$$\text{ESCF of } {}^3t_{2g}^1 e_g = 3 \times 2/5\Delta_o - 3/5\Delta_o = 3/5\Delta_o$$

***For low-spin (spin paired) octahedral complexes:***

The ESCF is maximum for the  $\text{Co}^{3+}$ , that is  $d^6$  electron configuration:  ${}^6t_{2g}^6 e_g^0$ .

$$\text{So, ESCF of } {}^6t_{2g}^6 e_g^0 = 6 \times 2/5\Delta_o = 12/5\Delta_o.$$

Any increase or decrease in the number of electrons at the  $d$  sublevel leads to lower the ESCF;

$$\text{ESCF of } {}^6t_{2g}^1 e_g \text{ (Ni}^{3+} \text{ and Co}^{2+}) = 6 \times 2/5\Delta_o - 3/5\Delta_o = 9/5\Delta_o$$

$$\text{ESCF of } {}^5t_{2g}^0 e_g \text{ (Mn}^{2+} \text{ and Fe}^{3+}) = 5 \times 2/5\Delta_o = 10/5\Delta_o$$

***The value of the ESCF reflects the kinetic inertness or lability of the complexes.***

That is  $[\text{Fe}(\text{CN})_6]^{3-}$  complex; Fe(III) and  $d^5$  electron configuration), has a low value of ESCF. It is a labile complex and so it is very toxic.  $[\text{Fe}(\text{CN})_6]^{4-}$  complex; Fe(II) and  $d^6$  electron configuration, has a high value of ESCF. It is an inert complex and it is not toxic.

As mentioned earlier that in tetrahedral complexes splitting (repulsion of orbitals) is less than in octahedral ones by:

$$\Delta_t \approx 4/9 \Delta_o .$$

Therefore, the probability of  $P < \Delta$  is lower in the tetrahedral complexes, and so tetrahedral complexes are more often of the high-spin (spin free) type, as opposed to the octahedral ones.

Sometimes, both configurations (octahedral and tetrahedral) are equally probable in complex formation:

*Consider Co(II) of  $d^7$ :*

In a weak field, the octahedral configuration takes the form  $^5t_{2g}^2e_g$  and in a tetrahedral configuration, the form is  $^4e_g^3t_{2g}$ , so that:

$$\text{ESCF}_{\text{oct.}} = 5 \times 2/5\Delta_o - 2 \times 3/5\Delta_o = 4/5\Delta_o$$

$$\text{ESCF}_{\text{tet.}} = 4 \times 3/5\Delta_t - 3 \times 2/5\Delta_t = 6/5\Delta_t$$

$$\text{Since } \Delta_t \approx 4/9 \Delta_o$$

$$\text{So } 6/5\Delta_t \approx 6/5 \times 4/9\Delta_o = 8/15\Delta_o \approx 3/5\Delta_o$$

$$\text{i.e., } \text{ESCF}_{\text{tet.}} \approx \text{ESCF}_{\text{oct.}}$$

For this reason, Co(II) complexes are characterized by equally probable occurrence of octahedral and tetrahedral forms:

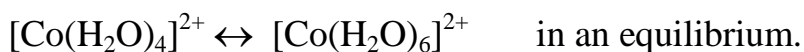

## Tetragonal Distortion of Octahedral Complexes: (Jahn-Teller Effect)

The stereochemistry or shape of any complex is determined by the tendency of electron pairs to occupy positions as far away from each other as possible, and also is affected by the presence of non-bonding  $d$  electrons.

If the  $d$  electrons are symmetrically arranged with respect to an octahedral ligand field, they will repel all six ligands equally and a completely regular octahedral structure will be formed. The symmetrical arrangements are shown in the following table:

Table : Symmetrical Electronic Arrangements

Elect. Config.	$t_{2g}$			$e_g$		Nature of Ligand field	Examples
	$d_{xy}$	$d_{xz}$	$d_{yz}$	$d_{x^2-y^2}$	$d_z^2$		
$d^0$						Strong or weak	$[\text{Ti}^{\text{IV}}\text{F}_6]^{2-}$
$d^3$	↑	↑	↑			Strong or weak	$[\text{Cr}^{\text{III}}(\text{H}_2\text{O})_6]^{3+}$
$d^5$	↑	↑	↑	↑	↑	Weak	$[\text{Mn}^{\text{II}}\text{F}_6]^{4-}$
$d^6$	↑↓	↑↓	↑↓			Strong	$[\text{Fe}^{\text{II}}(\text{CN})_6]^{4-}$
$d^8$	↑↓	↑↓	↑↓	↑	↑	Weak	$[\text{Ni}^{\text{II}}\text{F}_6]^{4-}$
$d^{10}$	↑↓	↑↓	↑↓	↑↓	↑↓	Strong or weak	$[\text{Zn}^{\text{II}}(\text{NH}_3)_6]^{2+}$

All other arrangements have an unsymmetrical arrangement of  $d$  electrons.

Asymmetric filling may arise either in the  $t_{2g}$  orbitals or in the  $e_g$  orbitals.

The asymmetric filling of the  $t_{2g}$  orbitals can be represented by the following table:

Table : Asymmetrical Electronic Arrangements of the  $t_{2g}$  Orbitals

Elect. Config.	$t_{2g}$			$e_g$		Nature of Ligand field	Spin type
	$d_{xy}$	$d_{xz}$	$d_{yz}$	$d_{x^2-y^2}$	$d_z^2$		
$d^1$	↑					Strong or weak	High spin
$d^2$	↑	↑				Strong or weak	High spin
$d^4$	↑↓	↑	↑			Strong	Low spin
$d^5$	↑↓	↑↓	↑			Strong	Low spin
$d^6$	↑↓	↑	↑	↑	↑	Weak	High spin
$d^7$	↑↓	↑↓	↑	↑	↑	Weak	High spin

Since the  $t_{2g}$  orbitals point in between the ligand directions, asymmetric filling of these orbitals has little effect on the stereochemistry; the shape of the formed complexes.

Asymmetric filling in the  $e_g$  orbitals can be represented by the following table:

Table : Unsymmetrical Electronic Arrangement in the  $e_g$  Orbitals

	$t_{2g}$	$e_g$	Field	Spin type	Examples
$d^4$	↑ ↑ ↑	↑	Weak	High spin	$Cr^{2+}, Mn^{3+}$
$d^7$	↑↓ ↑↓ ↑↓	↑	Strong	Low spin	$Co^{2+}, Ni^{3+}$
$d^9$	↑↓ ↑↓ ↑↓	↑↓ ↑	Strong or weak		$Cu^{2+}$

The  $e_g$  orbitals, in contrast to  $t_{2g}$  orbitals, point directly at the ligands, hence asymmetric filling of these orbitals causes some ligands to be repelled more than others. Accordingly, a significant distortion of the octahedral shape will be resulted.

The two  $e_g$  orbitals;  $d_{x^2-y^2}$  and  $d_{z^2}$ , are normally degenerate, but if the  $e_g$  level is asymmetrically filled in an octahedral environment, this degeneracy is destroyed, and the two orbitals are no longer equal in energy.

The  $d_{x^2-y^2}$  orbital has four lobes whilst the  $d_{z^2}$  orbital has only two lobes pointing at the ligands. To minimize the repulsion with the ligands, the single  $e_g$  electron will occupy the  $d_{z^2}$  orbital. This is equivalent to splitting the degeneracy of the  $e_g$  level so that  $d_{z^2}$  is more stable (of relative lower energy), whereas  $d_{x^2-y^2}$  is the less stable (of relative higher energy).

Thus the two ligands approaching along the +z and -z directions are subjected to greater repulsion than the four ligands along +x, -x, +y and -y.

The net result of the asymmetrical electronic arrangements in the  $e_g$  orbitals is an additional removing of degeneracy from  $d$  orbitals as shown in the following scheme:

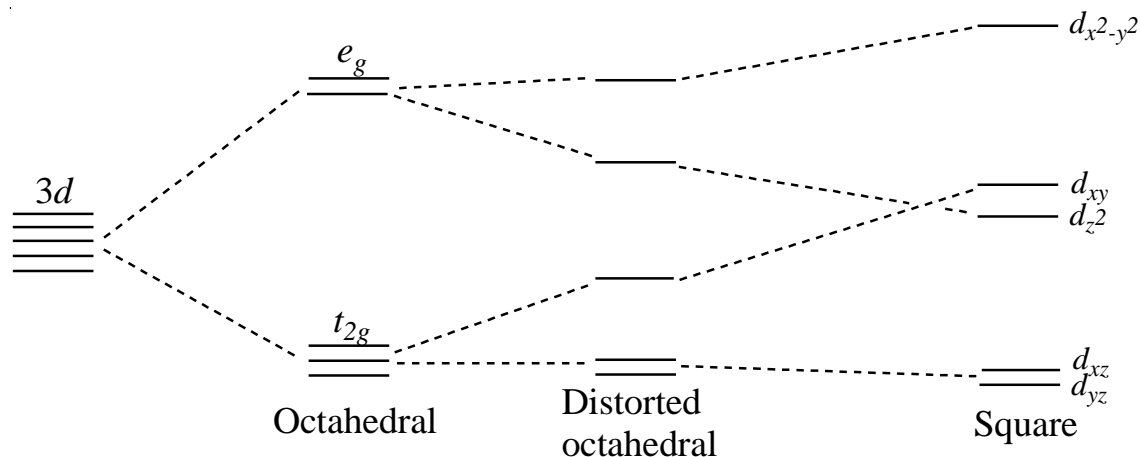

**Examples:**

$\text{Ni}^{2+}$  (with configuration  $d^8$ ) should provide the splitting  ${}^6t_{2g}^2e_g$  for both the strong and weak fields. However, the formed complexes of strong fields have the square shape, not the octahedral ones. This means that an additional removal of degeneracy from the  $d$  orbitals must be occurred.

Thus, if the  $\text{Ni}^{2+}$  ion finds itself in a field formed by a “strong” ligand responsible for splitting sufficient to compensate for the energy spent on pairing of the  $e_g$  level electrons, the square configuration of the field will be the most favorable. In a square complex (e.g.,  $[\text{Ni}(\text{CN})_4]^{2-}$ ), the vacant orbital in the  $\text{Ni}^{2+}$  ion is the  $d_{x^2-y^2}$ , which is characterized by the strongest electrostatic repulsion from the ligands. All  $d$  electrons of  $\text{Ni}^{2+}$  occupy low energy levels to ensure maximum **ESCF**.

$\text{Cu}^{2+}$  of  $d^9$  ( ${}^6t_{2g}^3e_g$ ) forms octahedral complexes with the weak fields, e.g. with  $\text{H}_2\text{O}$  it forms the complex  $[\text{Cu}(\text{H}_2\text{O})_6]^{2+}$ . With strong ligands  $\text{Cu}^{2+}$  forms square complexes, e.g.  $[\text{Cu}(\text{CN})_4]^{2-}$ .

The further (additional) removal of degeneracy; i.e. splitting, which is caused as a result of the strong field (ligands) depends mainly on the number of non-bonding electrons of the central metals.

This behavior is called **Jahn-Teller Effect**.

*Jahn-Teller effect* states that: any non-linear molecular system in a degenerate electronic state will be unstable and will undergo some kind of distortion that will lower its symmetry and splits the degenerate state.

The Jahn-Teller effect is pronounced if the state of degeneracy occurs at the  $e_g$  orbitals (rather than  $t_{2g}$ ) of an octahedral complexes.

In general, the complexes formed by the central metals of 1, 2 or 3 electrons in the  $e_g$  state are undergoing affected by the Jahn-Teller effect.

The following scheme shows the first row transition elements with their ability of the additional splitting (Jahn-Teller effect):

Table : Jahn-Teller effect on the first row transition elements.

	$t_{2g}$	$e_g$	Spin type	Jahn-Teller effect	Metals
$d^1$	1	0	High or low	No	Ti <sup>3+</sup>
$d^2$	2	0	High or low	No	Ti <sup>2+</sup> , V <sup>3+</sup>
$d^3$	3	0	High or low	No	Cr <sup>3+</sup>
$d^4$	3	1	High spin	Yes	Mn <sup>3+</sup>
	4	0	Low spin	No	
$d^5$	3	2	High spin	Yes	Mn <sup>2+</sup> , Fe <sup>3+</sup>
	5	0	Low spin	No	
$d^6$	4	2	High spin	Yes	Fe <sup>2+</sup> , Co <sup>3+</sup>
	6	0	Low spin	No	
$d^7$	5	2	High spin	Yes	Co <sup>2+</sup> , Ni <sup>3+</sup>
	6	1	Low spin	Yes	
$d^8$	6	2	High or low	Yes	Ni <sup>2+</sup>
$d^9$	6	3	High or low	Yes	Cu <sup>2+</sup>
$d^{10}$	6	4	High or low	No	Zn <sup>2+</sup>



## Electronic Absorption Spectra

One of the main corollaries of the CFT has to do with the absorption spectra of complex compounds, whose origin finds adequate explanation in this theory.

Consider, by way of example, the origin of the absorption spectrum of the titanium (III) aquo-ion of composition  $[\text{Ti}(\text{H}_2\text{O})_6]^{3+}$ .

The electron configuration of the  $\text{Ti}^{3+}$  ion is  $d^1$ . According to the CFT, the  $d^1$  electron occupies, in the octahedral field, the lowest-energy level  ${}^1t_{2g} {}^0e_g$ .

When the aquo-ion  $[\text{Ti}(\text{H}_2\text{O})_6]^{3+}$  is exposed to light, it absorbs energy quanta at a frequency  $\nu = \Delta_o/h$  ( $h$  is Planck constant).

The absorbed energy is expended in excitation of the electron in the  $t_{2g}$  orbital and, as a result, this electron will be transferred to the  $e_g$  orbital.

The absorption spectrum reveals a region in which the intensity of the transmitted light is lower than that of the incident one. This spectral region is known as the absorption band.

In the case of  $[\text{Ti}(\text{H}_2\text{O})_6]^{3+}$  the absorption band (as shown in the Fig.) is in the visible region of the spectrum and accounts for the red-violet coloration of the solutions and solid compounds containing the hexaquo-ion

of Ti(III). The maximum of the absorption band for  $[\text{Ti}(\text{H}_2\text{O})_6]^{3+}$  is at 5000 Å (or 20 000  $\text{cm}^{-1}$ ).

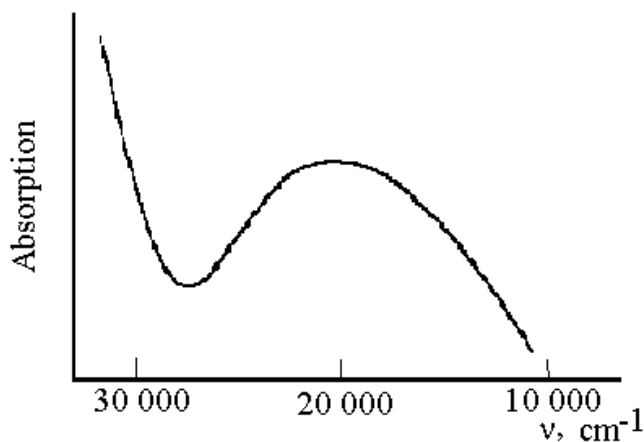

The visible absorption spectrum of  $[\text{Ti}(\text{H}_2\text{O})_6]$   
(*d-d transition*)

According to Planck's equation,  $E = hc/\lambda$ , where  $E$  is the energy of electron transfer from the ground to excited level; that is, in this case of  $[\text{Ti}(\text{H}_2\text{O})_6]^{3+}$ ,  $E = \Delta_o$ .

Knowing the wavelength corresponding to the maximum of the absorption band in the electron spectrum, one can calculate the splitting energy.

The maximum of the absorption band for  $[\text{Ti}(\text{H}_2\text{O})_6]^{3+}$  is 20 000  $\text{cm}^{-1}$ , and since there are 83.7  $\text{cm}^{-1}$  per kJ, so that the splitting energy ( $\Delta_o$ ) is ~ 240  $\text{kJ mol}^{-1}$  (or 57  $\text{kcal mol}^{-1}$ ),

For  $[\text{Ti}(\text{H}_2\text{O})_6]^{3+}$ , this task is rather simple because only one electron ( $d^1$ ) is excited. In more complex systems where exposure to light causes redistribution of two and more electrons among the energy sublevels, several transitions are possible giving rise to a number of absorption bands, which complicates the spectrum and its interpretation.

In general, it was indicated that by means of the CFT, the energy separations between various states of  $d$  electrons could be calculated from the frequencies of the absorption bands in the visible spectra.

It has been found that by experimental study of the spectra of a large number of complexes containing various metal ions and various ligands, that ligands may be arranged in a series according to their capacity to cause  $d$  orbital splittings. That is the so-called *Spectrochemical Series*.

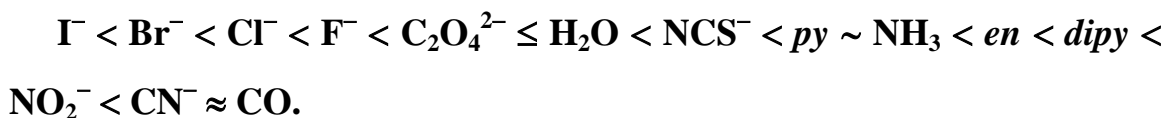

The idea of this series is that the  $d$  orbital splittings and hence the relative frequencies of visible absorption bands for two complexes containing the same metal ion but different ligands can be predicted from the above series whatever the particular metal ion may be.

Naturally, one cannot expect such a simple and useful rule to be universally applicable. The following qualifications must be remembered in applying it:

1. The series is based upon data for metal ions in common oxidation states. Because the nature of the metal–ligand interaction in an unusually high or unusually low oxidation state of the metal may be in certain respects qualitatively different from that for the metal in a normal oxidation state. This means that ligands may not follow the order of the spectrochemical series when they interact with metal of unusual oxidation states.
2. Even for metal ions in their normal oxidation states inversions of the order of adjacent or nearly adjacent members of the series are sometimes found.

## The colors of coordination compounds

One of the most interesting properties of the transition elements is that their complexes are usually colored. With an understanding of  $d$  orbital splitting, the origin of the color can be explained.

Knowing that, white light covers a range of different colors, from red light of low energy and long wavelength to violet light of high energy and short wavelength.

We perceive the color of transition metal complexes in solution by the color of the transmitted or nonabsorbed light. A solution of the compound absorbs light of one or more colors, and the color or colors not absorbed are perceived by our eyes.

The six components of white light consist of three primary colors (red, yellow, and blue) and three secondary colors (orange, green, and violet) which can be made by mixing the primary colors in pairs as follows:

Red + Yellow  $\rightarrow$  Orange

Yellow + Blue  $\rightarrow$  Green

Blue + Red  $\rightarrow$  Violet

A convenient way to remember this is to arrange the colors circularly on an “artist’s wheel”.

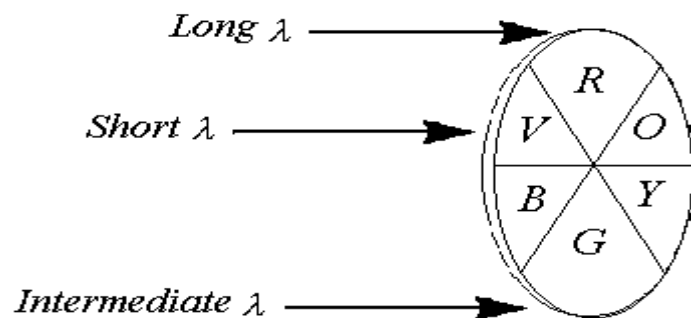

Artist's Wheel

Colors on opposite sides of the wheel are complementary; they add together to give white light.

If a solution absorbs light of one or more colors on one side of the wheel, the remaining colors will be seen. Thus, if the green color is seen, this means one of two things happened. If all but green light is absorbed, only green light is transmitted. Alternatively, if violet, red, and orange were absorbed, then blue, green, and yellow are transmitted, and we will see the middle of color of the three; that is the green color.

Spectrophotometers select photons (which consist white light) of each different frequencies to pass through a solution of the compound to be studied.

If photons of a given frequency are not absorbed, that light is unchanged in its intensity when it emerges from the sample. On the other hand, if photons of some frequency are absorbed, light of that frequency emerges from the sample with a decreased intensity.

By making a plot of the frequency or wavelength of the light against the intensity of the light absorbed at that frequency or wavelength, we obtain an *absorption spectrum* of the sample. When there is an absorption of light in a certain frequency range, the plot shows an *absorption band*, and the variation in intensity of light absorbed with frequency is called a *spectrum*.

Transition metal complexes can absorb light because photons of the appropriate energy can excite the complex from its ground state to a higher energy or excited state: in the octahedral complexes, as a result of excitation, an electron (or electrons) is transferred from the  $t_{eg}$  orbitals to the  $e_g$  ones.

The fact that high energy light is transmitted means that low energy light was absorbed.

Referring to the Spectrochemical series; predicting the possible color of a complex based on the nature of the ligands is risky, since the details of the spectroscopy of such complexes are complicated.

However, it is clear that weak field ligands lead to a small splitting, so the complex will absorb relatively low energy photons. Like  $[\text{Cu}(\text{H}_2\text{O})_6]^{2+}$  ion or  $[\text{CoF}_6]^{3-}$ , such complexes *tend to* have colors at the blue end of the spectrum.

Conversely, strong field ligands cause a large splitting, and their complexes, like  $[\text{Co}(\text{CN})_6]^{3-}$ , *tend to* have colors at the red end of the spectrum.

The following table represents the spectral properties of some cobalt (III) complexes.

Co <sup>3+</sup> complex	Wavelength of Light absorbed (nm)	Color of light absorbed	Color seen
[CoF <sub>6</sub> ] <sup>3-</sup>	700	Red	Green
[Co(H <sub>2</sub> O) <sub>6</sub> ] <sup>3+</sup>	600	Orange	Blue
[Co(NH <sub>3</sub> ) <sub>5</sub> Cl] <sup>2+</sup>	535	Yellow	Purple
[Co(NH <sub>3</sub> ) <sub>5</sub> H <sub>2</sub> O] <sup>3+</sup>	500	Blue-green	Red
[Co(NH <sub>3</sub> ) <sub>6</sub> ] <sup>3+</sup>	475	Blue	Yellow-orange
[Co(CN) <sub>6</sub> ] <sup>3-</sup>	310	Ultraviolet	Tail of absorption band in visible gives pale yellow



## The Ligand Field Theory (LFT):

The ligand field theory (LFT) was elaborated by J. H. Van Velck in the thirties and forties of the 20<sup>th</sup> century.

It incorporates the concepts of the molecular orbital and crystal field theories.

### *The basic principles of the LFT are as follows:*

1. Unlike the CFT, the LFT posits that the formation of complex compounds, accompanied by removal of degeneracy from the *d* orbitals of the central ion, involves not only electrostatic forces but, also, primarily, overlapping of the orbitals of the central ion and ligand – that is, covalent interaction.
2. The interaction of two atomic orbitals, those of the central atom and ligand, results in formation of two molecular orbitals. One of them (***bonding***) lies below the interacting atomic orbital with the lower energy. The other (***antibonding***) lies above the other, higher-energy atomic orbital.
3. According to the LFT, only atomic orbitals of *similar symmetry* may interact. For example, the orbital of  $\sigma$ -symmetry belonging to the central ion and ligand may overlap. Those of  $\pi$ -symmetry, also belonging to the central ion and ligand, may overlap, too. If the

atomic orbitals of the central ion lack a partner of appropriate symmetry among those of the ligand, they remain *nonbonding* without changing their energy characteristics and becoming involved in bonding.

4. In the LFT, Pauli's principle and Hund's rule remain valid.

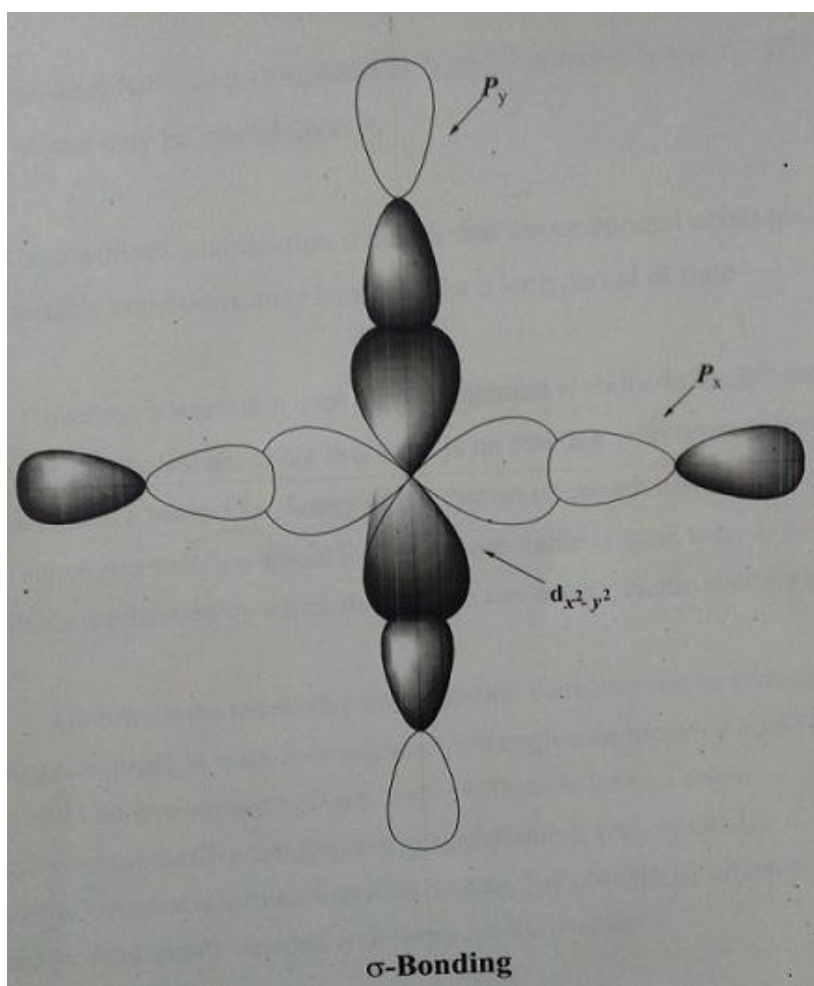

Consider now the structure of high- and low-spin complexes of Co(III) in the light of the LFT:

(i) The complex  $[\text{CoF}_6]^{3-}$  represents high-spin complexes:

The complex  $[\text{CoF}_6]^{3-}$  was already discussed in the contexts of the VBT and CFT.

It will be recalled that the  $\text{F}^-$  ions are on the left-hand side of the spectrochemical series and, as a rule, form a weak field in which high-spin complexes are stable.

$\text{Co}^{3+}$  has a  $d^6$  configuration, and, in the weak field of an octahedral complex, electrons are distributed in accordance with Hund's rule applicable to all of the five  $3d$  orbitals of  $\text{Co}^{3+}$ :  $t_{2g}^4 e_g^2$ .

The ligands, or six  $\text{F}^-$  ions, have unshared electron pairs at an atomic orbital ( $2p$ ) below that of the valence electrons of  $\text{Co}^{3+}$  ( $3d$ ). In addition to the  $3d$  orbital of  $\text{Co}^{3+}$ , we shall also take into account its vacant  $4s$  and  $4p$  orbitals.

Thus, the interaction involves six  $p$  orbitals of  $\text{F}^-$ , accommodating 12 electrons, and nine orbitals of  $\text{Co}^{3+}$  ( $3d$ ,  $4s$ ,  $4p$ ), accommodating a total of six electrons.

The interaction of 15 atomic orbitals must yield 15 *molecular orbitals*, including equal numbers of *bonding* and *antibonding* plus *nonbonding* orbitals.

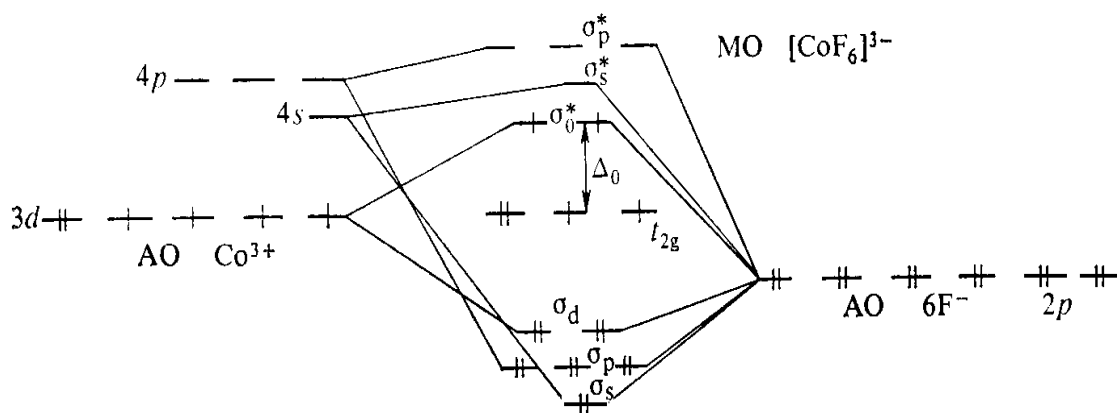

The bonding molecular orbitals in the complex  $[\text{CoF}_6]^{3-}$  are formed from the atomic orbitals of the ligand, but along the energy axis they lie below the atomic orbitals of the six  $\text{F}^-$  ions.

Since the atomic orbitals of the  $\text{F}^-$  ions have a  $\sigma$ -symmetry, the bonding molecular orbitals based on them result from the overlapping of the atomic  $\sigma$ -orbitals of the  $\text{F}^-$  ions with those of the  $\text{Co}^{3+}$  ions. These are  $3d_{z^2}$ ,  $3d_{x^2-y^2}$ , and also  $4s$ ,  $4p_x$ ,  $4p_y$ , and  $4p_z$  orbitals.

The resulting six bonding molecular orbitals (one  $\sigma_s$ , three  $\sigma_p$ , and two  $\sigma_d$ ) are occupied by the electron pairs of the ligand (six  $\text{F}^-$  ions).

At the same time, six antibonding molecular orbitals, also of  $\sigma$ -symmetry, are formed. They (two lowest-energy degenerate  $\sigma_d^*$  orbitals) accommodate two lone-pair electrons of  $\text{Co}^{3+}$ .

Four electrons from the atomic  $3d$  orbitals of  $\text{Co}^{3+}$  remain at the  $3d_{xy}$ ,  $3d_{xz}$ , and  $3d_{yz}$  orbitals and are nonbonding. These atomic orbitals are of  $\pi$ -symmetry and do not overlap with those of the ligand.

Note that, the bonding orbitals (there are six of them) lie at an energy level below the atomic orbitals, whereas the antibonding ones (also six) lie above the  $3d$  ( $e_g$ ),  $4s$ , and  $4p$  orbitals of the  $\text{Co}^{3+}$  ion, on which they are based.

Just as the CFT, the LFT also takes into account the amount of splitting, for example  $\Delta_o$ , in an octahedral field, which is essentially the difference between the energies of the  $e_g$  and  $t_{2g}$  orbitals. Here, the nonbonding molecular orbitals are taken as the  $t_{2g}$  level, and the antibonding ones, as the  $e_g$  level.

Although the electrons of  $\text{Co}^{3+}$  have not changed their energy as a result of complexing, the system as a whole has gained energy since the ligand electrons are now at a lower energy level than before the interaction with  $\text{Co}^{3+}$ .

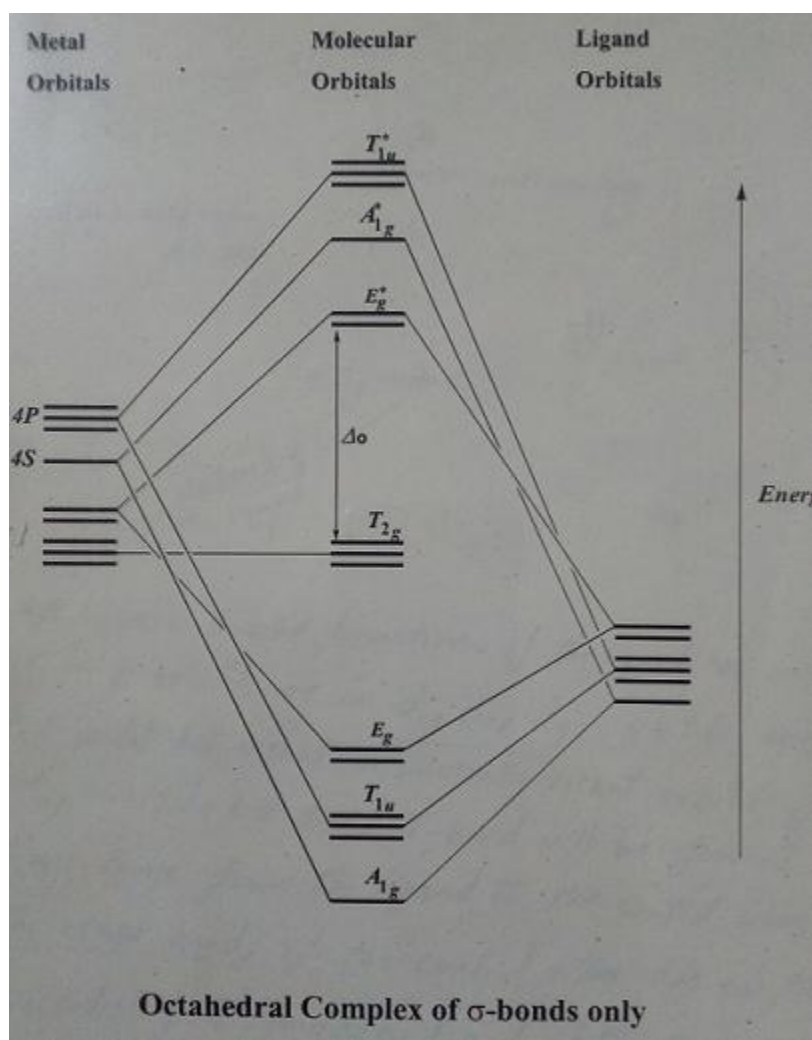

(ii)  $[\text{Co}(\text{NH}_3)_6]^{3+}$  complex may represent the low-spin complexes:

In the low-spin complex  $[\text{Co}(\text{NH}_3)_6]^{3+}$ , the gain in energy is greater because all electrons of  $\text{Co}^{3+}$  are paired and occupy the nonbonding  $t_{2g}$  orbitals of  $\pi$ -symmetry, whereas the antibonding orbitals are vacant.

At the same time, all of the 12 electrons of the ligand, involved in complexing, have their energy lower and occupy the bonding  $\sigma$ -orbitals, which ensures a gain in energy for the entire system.

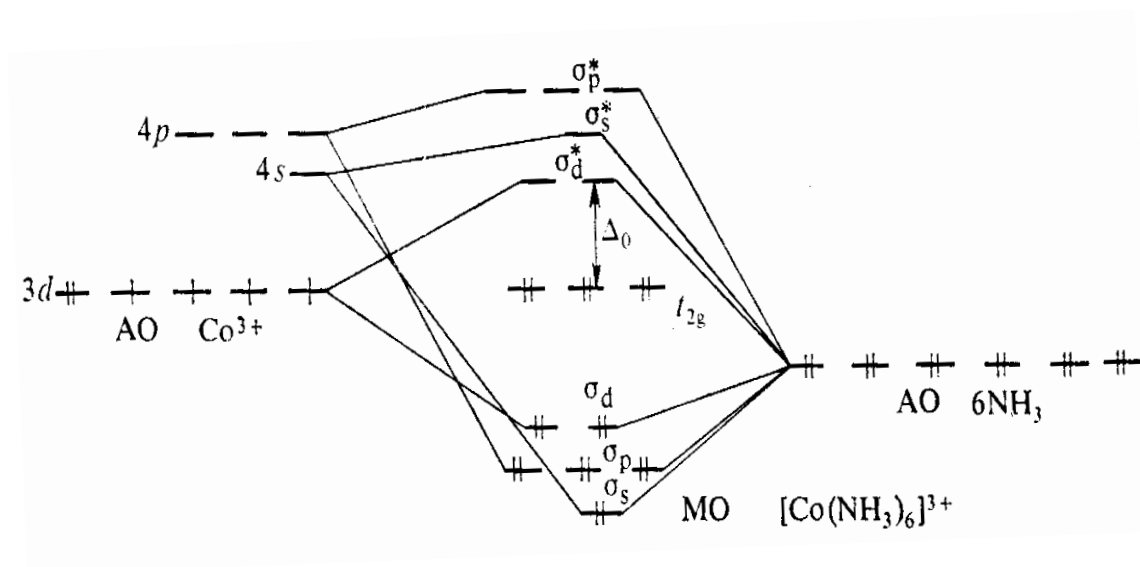

The above structure of  $\text{Co}^{3+}$  interpreted in terms of the LFT is oversimplified.

If the value of  $\Delta_0$  had depended on the electrostatic interaction in the complex or only on the strength of the  $\sigma$ -bonds, it would have been possible

to consider the strength of the bond in the complex as being proportional to  $\Delta_o$ .

In reality, however,  $\pi$ -interactions almost always go hand in hand with  $\sigma$ -bonding. Note that, in the CFT the  $\pi$ -bonding could not be taken into account, whereas in the LFT this can be done.

For example, let a  $p$  orbital lie in the  $xy$  plane at the donor atom. It will then be capable of interacting with the  $d_{xy}$  orbital of the central ion, resulting in a  $\pi$ -bond; hence if the  $p$  orbital of the ligand has unshared electron pair and the  $d_{xy}$  orbital of the central ion is vacant or partially occupied by electrons, donor-acceptor  $\pi$ -bonding occurs.

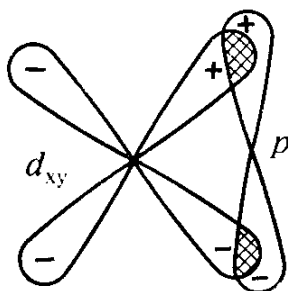

Since ligands are usually more electronegative than the central atom, the lower-lying molecular orbital resulting during such interaction resembles the atomic orbital of the ligand (bonding  $t_{2g}$  orbital), while the higher-lying molecular orbital is similar to the atomic orbital of the central ion (antibonding  $t_{2g}$  orbital). Electrons tend to occupy the former because filling a low-lying orbital is energetically more productive. The latter molecular



orbital (of the central atom) remains vacant or partially occupied, although, it becomes an antibonding  $t_{2g}$  orbital.

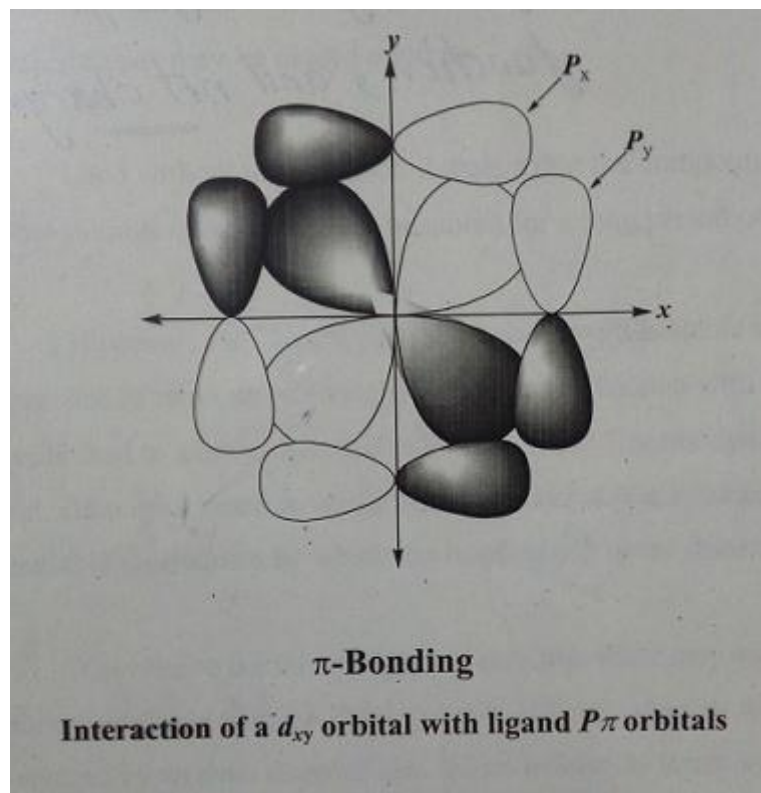

Such  $\pi$ -bonding (“**donor**” or “**direct**”  $\pi$ -bonding) leads to an increase in the energy of the  $t_{2g}$  orbitals of the metal and a decrease in  $\Delta_o$ . In this case, the  $t_{2g}$  orbitals of the central ion cease (stop) to be nonbonding as in complexes having only  $\sigma$ -bonds. Such  $\pi$ -interaction occurs if the ligands are halogen ions,  $H_2O$ , alcohols, sulphide ions and so on.

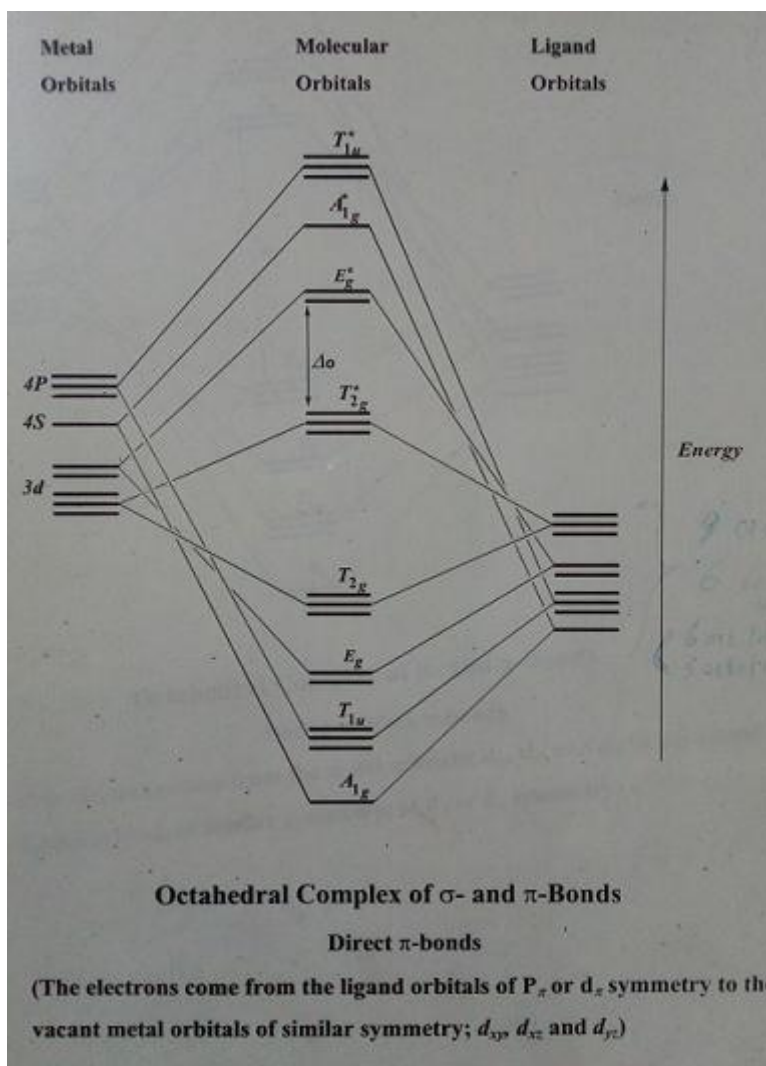

If the vacant orbitals involved in the  $\pi$ -bonding belonging to the ligand while the donor electrons belong to the atomic  $t_{2g}$  orbital, the  $\pi$ -bond is referred to as “**backward**” or “**dative**”. In this case, the bonding molecular orbital results from the atomic orbital of the metal ion.

The antibonding molecular orbital resembles more closely the atomic orbital of the ligand.

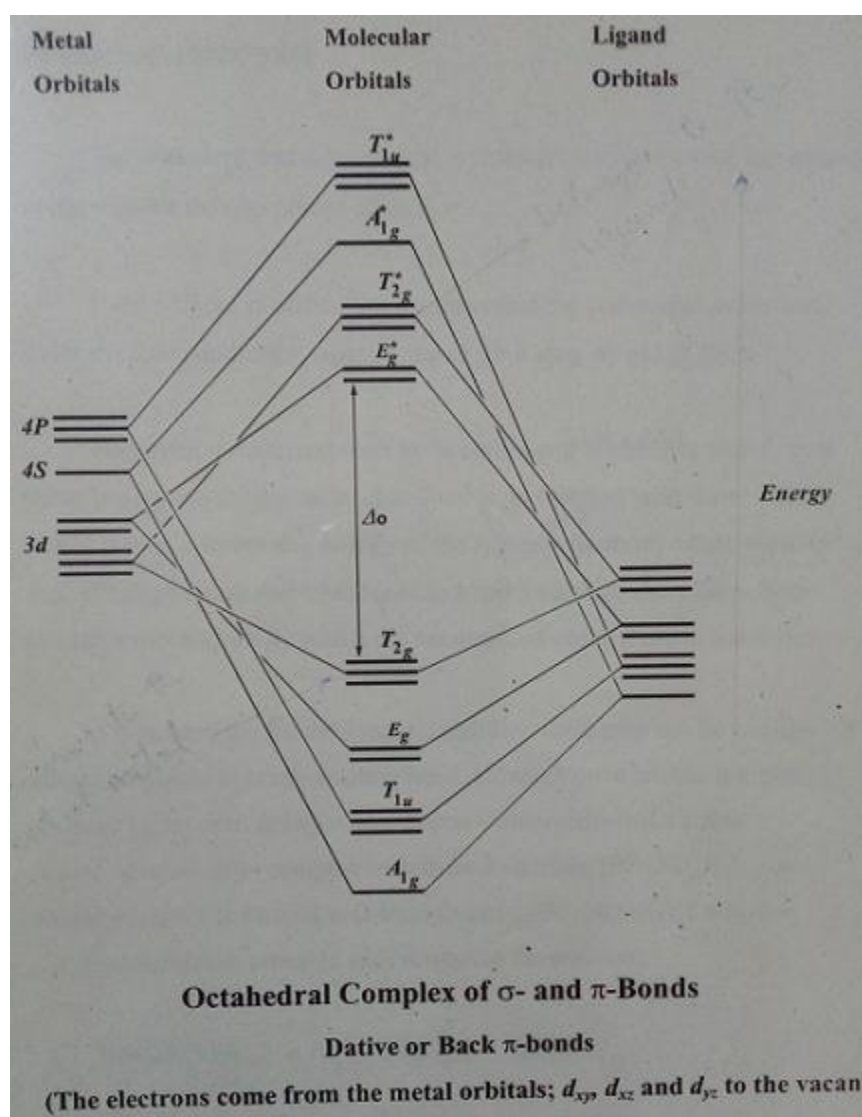

Dative bonding increases  $\Delta_o$  because the  $t_{2g}$  orbitals of the central ion become involved in bonding and their energy level goes down, as compared to the atomic orbitals or complexes having only  $\sigma$ -bonds.

Dative bonding also increases the positive charge at the central ion, which enhances the contribution of electrostatic forces to complexing as well as strengthens the covalent coordinate bond: the  $t_{2g}$  and  $e_g$  orbitals become spaced wider apart.

The CO and  $\text{CN}^-$  ligands are capable of forming dative bonds owing to the vacant antibonding  $p$  orbitals at the carbon, while the halide anions ( $\text{Cl}^-$ ,  $\text{Br}^-$ ,  $\text{I}^-$ ) can do the same through vacant and rather low-lying  $d$  orbitals.

**List of References for this Course:**

1- A New Concise Inorganic Chemistry

J.D. LEE

2- Methodological Aspects of the Course in Inorganic Chemistry

L.I. Martynenko and V.I. Spitsun

3- Fundamental Concepts of Inorganic Chemistry

E.S. Gilreath

4- Coordination Compounds

S. F. A. Kettle

5- Advanced Inorganic Chemistry: A Comprehensive Text

Cotton and Wilkinson

6- Principles of Chemistry

Davis, Gailey and Whitten

7- Chemistry: Science of Change

Oxtoby, Nachtrieb and Freeman

8- Chemistry & Chemical Reactivity

Kotz and Purcell

## Course 452 Ch: Inorganic Chemistry: Part (III): Inorganic Structure

### Inorganic Structure

*N.B.: The source of this course is the references and books mentioned at the end.*

#### *Attainment of a Stable Configuration*

How do atoms combine together to form molecules and why do atoms form bonds?

The molecule formed must be more stable than the individual atoms, or molecules would not be formed, i.e. the process must be energetically favorable and lead to a minimum energy.

Atoms of the noble gases do not normally react with any other atoms and their molecules are monoatomic – that is, they contain only one atom. The lack of reactivity indicates that these atoms are extremely stable, their energy being so favorable that it cannot be improved by compound formation.

The inert gases all have a complete outer shell of electrons, so that we can conclude that this is a very stable arrangement.

Accordingly, the atoms combine together to reach the electronic configuration of the next inert gas.

### ***Types of Bonds***

There are several ways in which atoms may obtain a stable electronic configuration: by losing, gaining or sharing electrons.

- (a) Electropositive elements, whose atoms give up one or more electron fairly readily,
- (b) Electronegative elements which take up electrons, and
- (c) Elements which neither tend to loss nor gain electrons.

Accordingly, the following three main types of bonds are formed:

**Electropositive elements + Electronegative elements → Ionic bond**

**Electronegative elements + Electronegative elements → Covalent bond**

**Electropositive elements + Electropositive elements → Metallic bond**

The types of bonds are idealized or extreme representation, and in most substances the bond type is somewhere in between these extreme forms, though generally one of these types predominates.

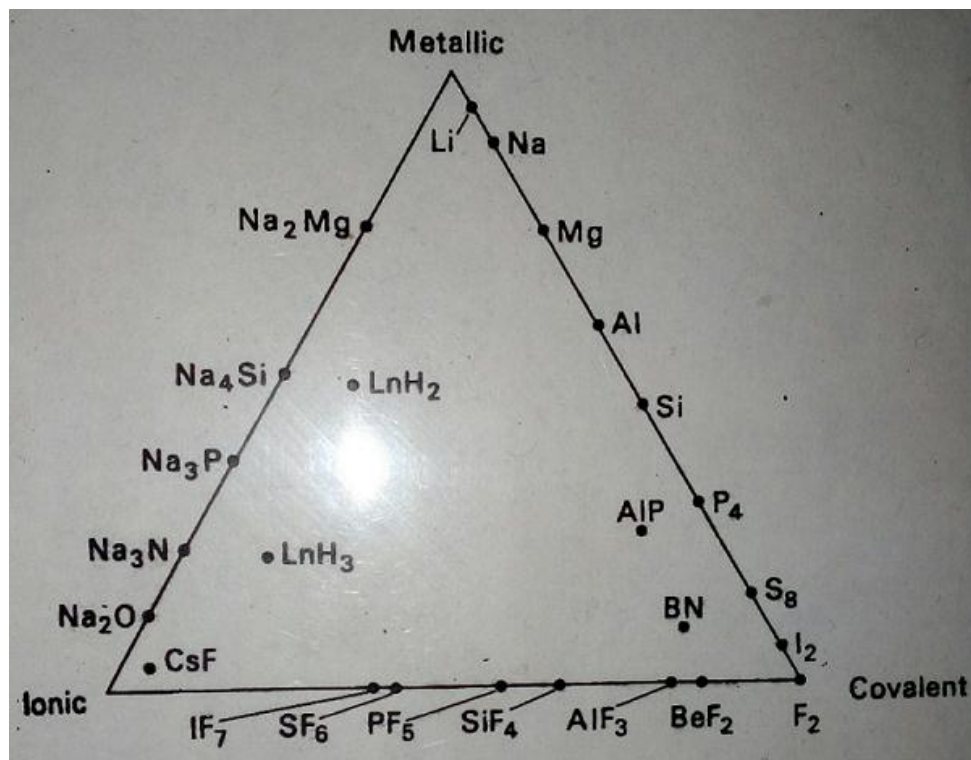

For example, lithium chloride is considered to be an ionic compound, but it is soluble in alcohol, which suggests that it also possesses a small amount of covalent character.



### ***General Properties of Ionically and Covalently Bonded Compounds:***

Compounds containing ionic linkages are made up of positive and negative ions arranged together in a regular way in a lattice. Compounds with covalent bonds are usually made up of discrete molecules.

In ionic compounds, the attraction between ions is electrostatic and non-directional, and extends equally in all directions. In covalent compounds, the bonds are directional, and strong covalent bonding forces exist between the atoms in a molecule.

Ionic compounds are very hard solids and they have high melting and boiling point, because a considerable high energy is necessary to break the lattice and to melt the compounds. Covalently bonded compounds are often gases, liquids or soft solids with low melting points (in covalent solid compounds, the only forces between one molecule and another are weak van der Waals forces).

Ionic compounds conduct electricity because ions migrate towards the electrodes when the compound is melted or in solution. In an ionic crystal, the ions are trapped in fixed places in the crystal lattice; hence they cannot migrate and therefore cannot conduct electricity. If the crystal is not perfect (most crystals have defects) and a lattice site is left vacant, that is an ion is missing, some very slight conduction may occur by migration of an ion from its lattice site to the vacant site. In contrast, covalent compounds are insulators. They have no electric charges and carry no current in either the solid, liquid or gaseous state.

Ionic compounds are usually soluble in polar solvents: that is solvents of high dielectric constant such as water. Covalent compounds are not normally soluble

in these solvents but are soluble in non-polar (organic) solvents: that is, solvents of low dielectric constant such as benzene and carbon tetrachloride.

Ionic reactions are usually rapid, since the reacting species have only to collide. Covalent compounds usually react slowly since the reaction usually involves breaking a bond and substituting or adding another group. Thus, collisions between the reactant molecules will only cause reaction if they have sufficient energy.

It is important to realize that bonds are not necessarily 100% covalent or 100% ionic and that bonds of intermediate character exist. In a molecule made up of two identical atoms, both atoms have an equal tendency to gain electrons, so that the electron pair forming the bond is equally shared by both atoms. This constitutes a 100% covalent bond. In molecules formed between different atoms, the tendency to gain electrons differs – hence the bond pair electrons is unequally shared by the two atoms, one atom having a very small negative charge  $\delta^-$  and the other a small positive charge  $\delta^+$



This covalent bond is therefore partially ionic in character.

## ***Metallic Bonds and Metallic Structures***

Metals are made up of positive ions packed together, usually in one of the three following geometrical arrangements:

- (1) Hexagonal close-packed
- (2) Cubic close-packed (Face-centered cubic)
- (3) Body-centered cubic

Negatively charged electrons hold the ions together, and the positive and negative charges are balanced, since the electron originated from the neutral metal atoms.

The outstanding feature of metals is their very high electrical conductivity, which is due to mobility of these electrons through the lattice.

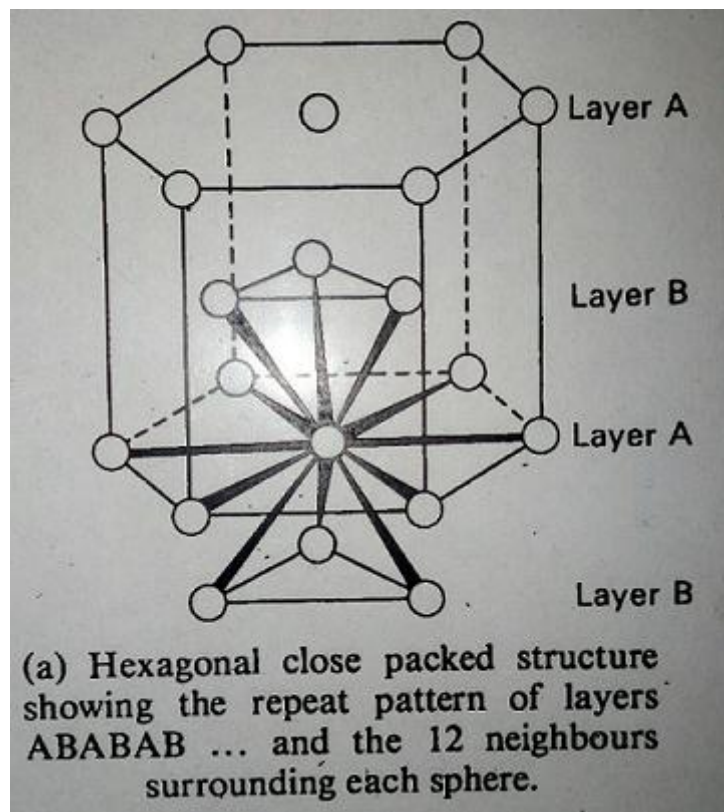

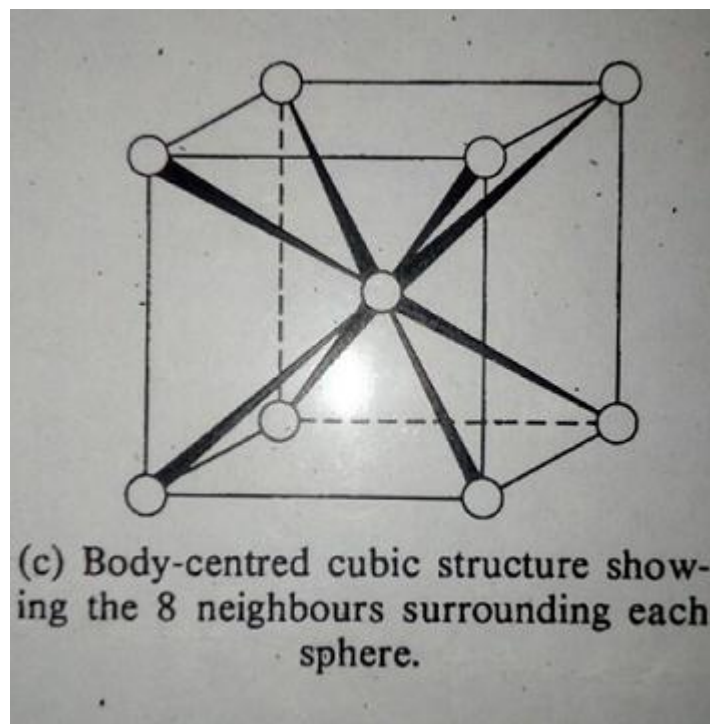
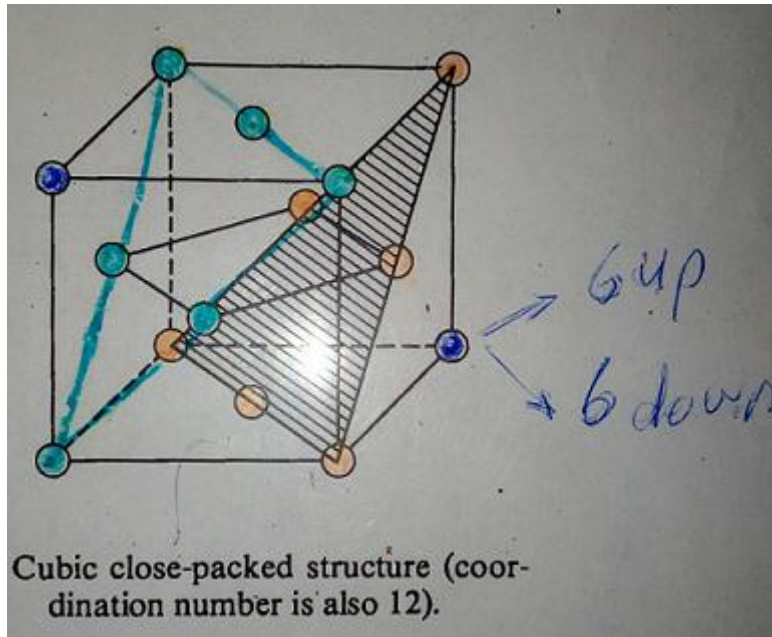

Two of these arrangements (cubic close-packed and hexagonal close-packed) are based on the closest packing of spheres.

The metal ions are assumed to be spherical, and are packed together to fill the space most effectively as shown below:

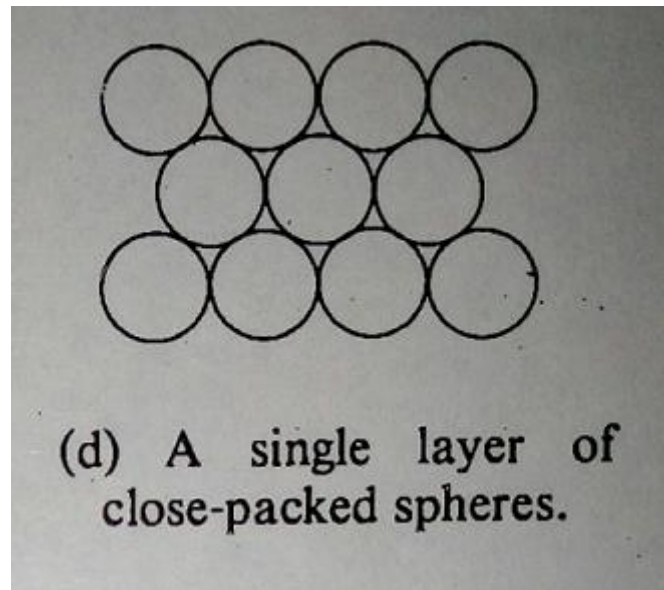

Each sphere touches six other spheres within this one layer.

A second layer of spheres is arranged on top of the first layer, the protruding parts of the second layer fitting into the hollows in the first layer:

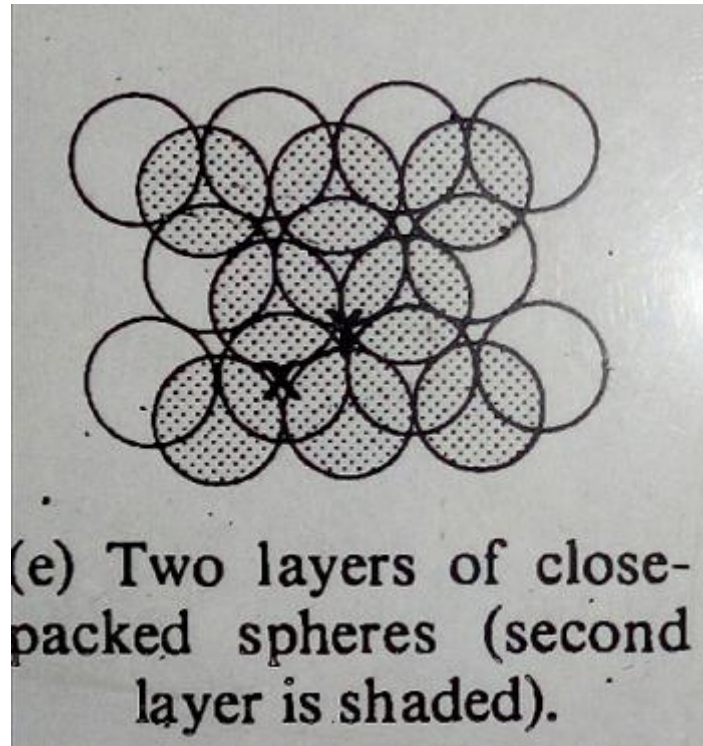

A sphere in the first layer touches three spheres in the layer above it, and similarly it touches three spheres in the layer below it, plus six spheres in its own layer, making a total of twelve. The coordination number, or the number of atoms or ions in contact with a given atom, is therefore 12 for a close-packed arrangement.

With a close-packed arrangement, the spheres occupy 74% of the total space, whereas the remaining 26% of the total are holes.

When adding a third layer of spheres, two different arrangements are possible, each preserving the close-packed arrangement:

If the first sphere of the third layer is placed in the depression X shown in the previous figure.

It can be seen that this sphere is exactly above a sphere in the first layer.

It follows that every sphere in the third layer is exactly above one of the first layer. If the first sheet is represented by A, and the second sheet by B, the repeating pattern of the close-packed sheets is ABABAB....., and such a structure is said to be hexagonal close-packed.

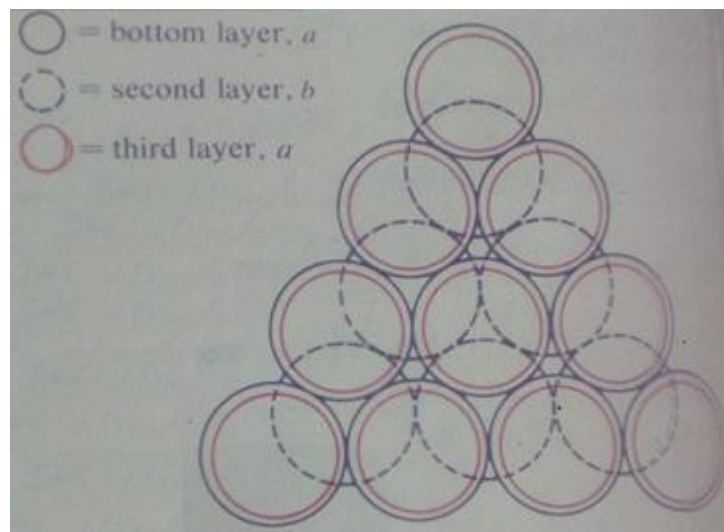

Alternatively, the first sphere of the third layer may be placed in a depression such as Y in the figure. The sphere is not exactly above a sphere in the first layer, and it follows that all the spheres in the third layer are not exactly above spheres in the first layer. If the three layers are represented A, B and C, the repeating pattern of sheets is ABCABCABC..., and such a structure is said to be cubic-close packed. An alternative name for this structure is face-centered cubic.

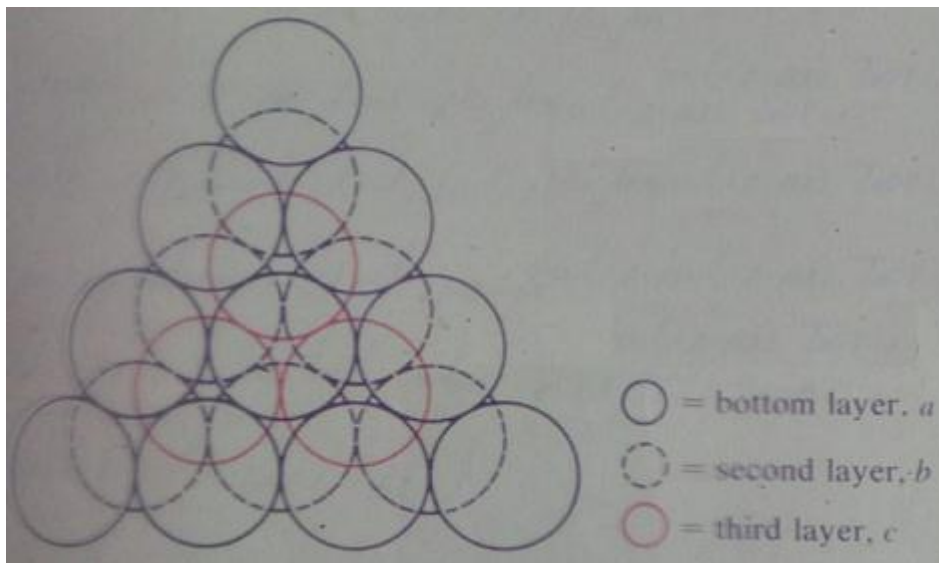



The third common metallic structure is called body-centred cubic.

The spheres are packed in sheets as shown below:

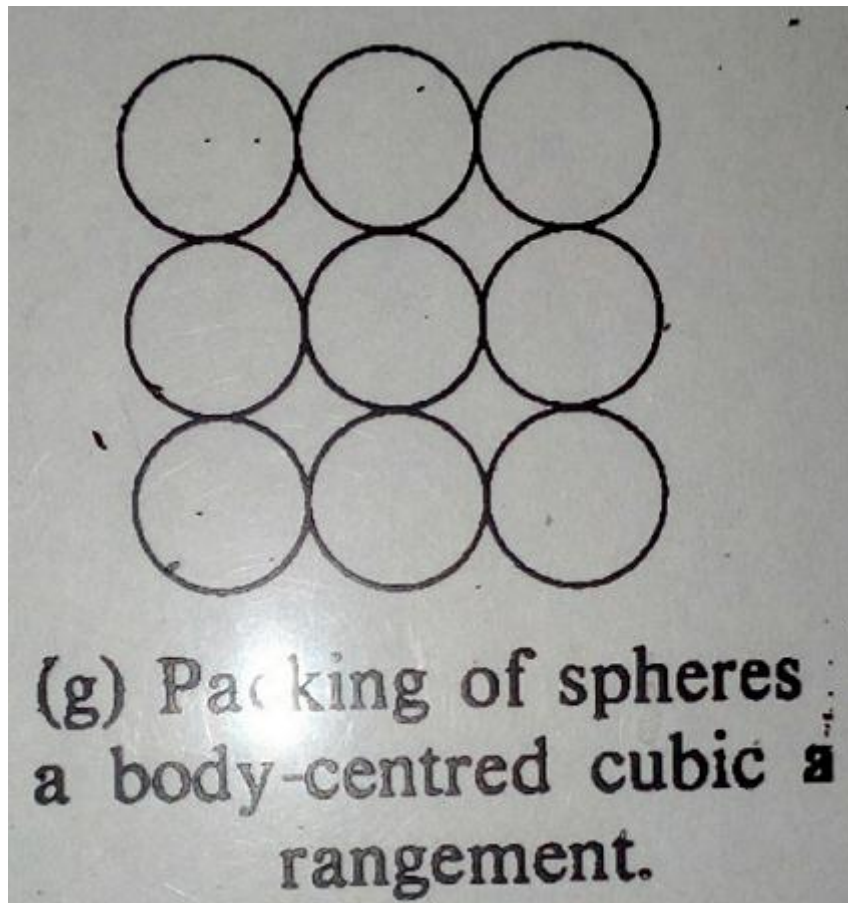

This form of packing is rather less efficient at filling the space than the closest packing, and the spheres occupy 68% of the total space, and 32% of the total space are holes.

The coordination number of the body-centred arrangement is then 8.

## Structures of Ionic Solids

### *The coordination number*

In an ionic solid, positive ions are surrounded by negative ions, and vice versa.

Normally each ion is surrounded by the greatest possible number of oppositely charged ions and this number is called the coordination number.

The coordination numbers of positive and negative ions are the same if there are equal numbers of both ions, as in NaCl, and are different when there are different numbers of both ions, as in CaCl<sub>2</sub>.

The coordination number is related to the relative sizes of the ions.

### *Radius Ratios and Limiting Radius Ratios*

When the coordination number is three in an ionic compound AX, three X<sup>-</sup> ions are in contact with one A<sup>+</sup> ion:

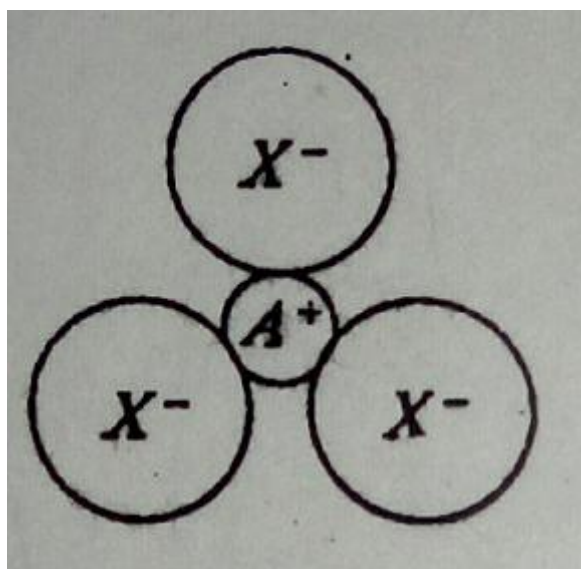

A limiting case arises when the  $X^-$  ions are also in contact with one another:

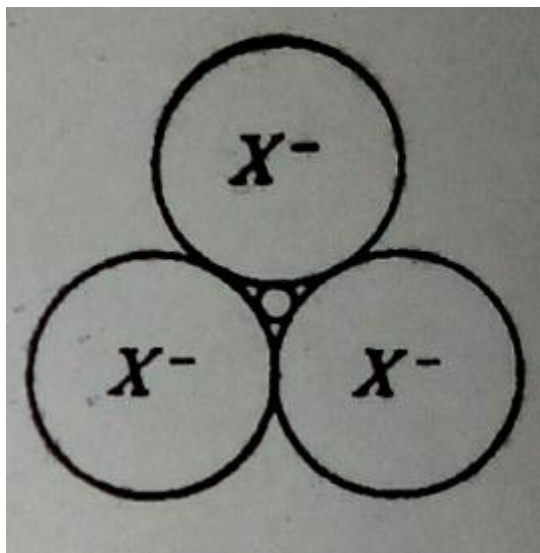

By simple geometry this gives the ratio: radius  $A^+$ /radius  $X^- = 0.155$ . If the ratio falls below this value then the structure is unstable:

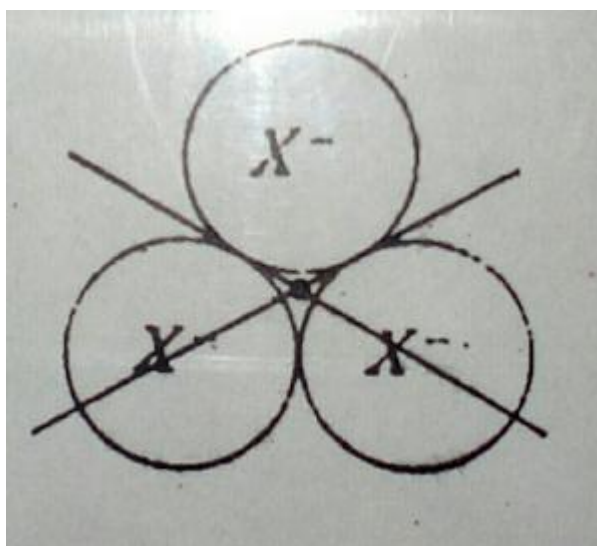

Coordination numbers 3, 4, 6 and 8 are common, and the appropriate limiting radius ratios can be worked out.

Thus, if the ionic radii are known, the radius ratio can be calculated and hence the coordination number and shape may be predicted. Some of coordination numbers, their limiting radius ratios and the predicted corresponding shapes are given in the following table.

Coordination number	Shape	Limiting radius ratio $r^+/r^-$
3	Planar triangle	0.155 – 0.225
4	Tetrahedral	0.225 – 0.414
4	Square planar	0.414 – 0.732
6	Octahedral	0.414 – 0.732
8	Body-centred cubic	0.732 – 1.000

### ***Close Packing***

Many common crystal structures are related to, and may be described in terms of, hexagonal or cubic close-packed arrangements.

In a close-packed arrangement of spheres, 26% of the space is unoccupied, and may be regarded as holes in the crystal lattice.

Two different types of hole occur. Those marked T (in the Fig. below) are bounded by four spheres and are called tetrahedral holes, and those marked O (in this Fig.) are bounded by six spheres are called hexagonal holes.

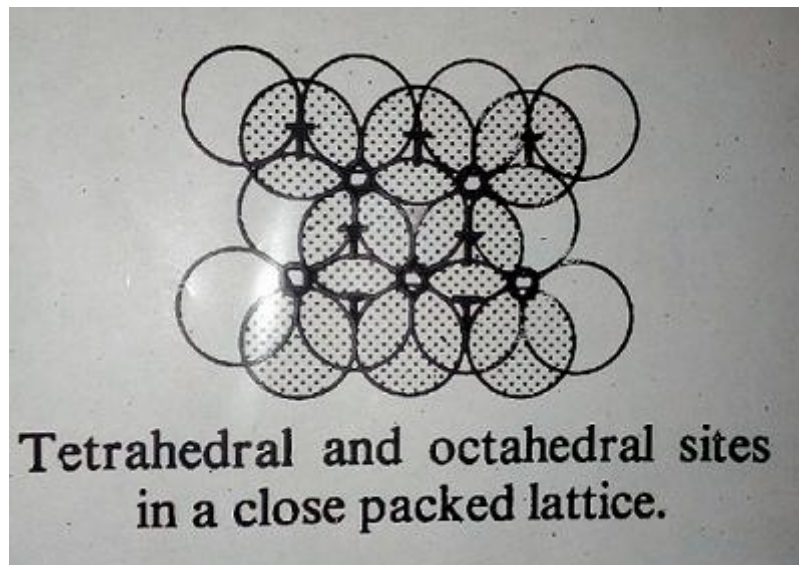

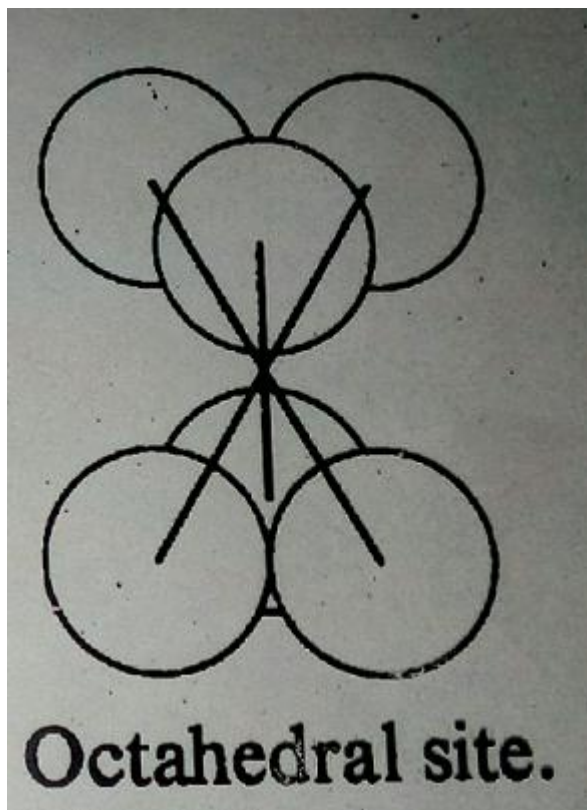
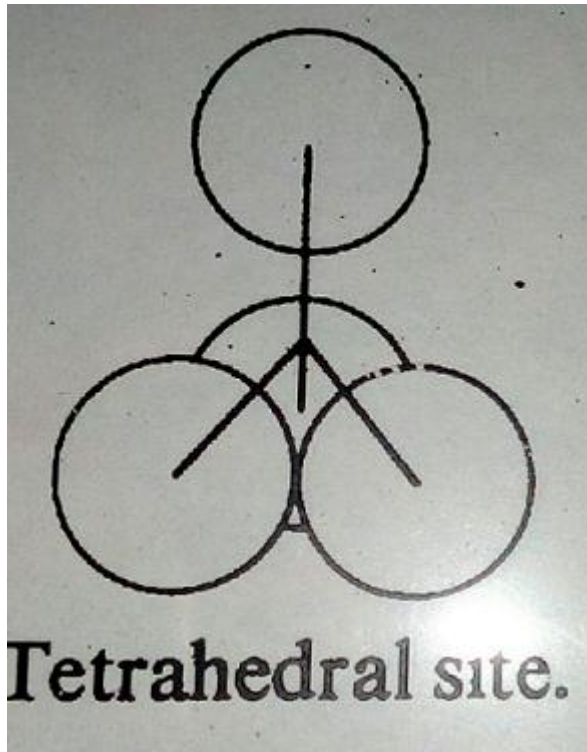

For every sphere in the close-packed arrangement there will be one octahedral hole and two tetrahedral holes. The octahedral holes are larger than the tetrahedral holes.

An ionic structure is composed of oppositely charged ions. If the larger ions are close-packed, then the smaller ions may occupy either the octahedral holes or the tetrahedral holes depending on their size. Normally the type of hole occupied can be obtained from the radius ratio. Thus an ion occupying a tetrahedral hole has a coordination number of four, whilst one occupying an octahedral hole has a coordination number of six.

In some compounds the relative sizes of the ions are such that the smaller ions are too large to fit in the holes, and they force the larger ions out of contact with each other so that they are no longer close packed. Despite this, the relative positions of the ions remains unchanged, and it is convenient to retain the description in terms of loose packing.

### ***Ionic Compounds of the Type AX (ZnS, NaCl, CsCl)***

Three structural arrangements commonly found are zinc sulphide, sodium chloride and cesium chloride structures.

#### ***Zinc Sulphide Structure***

In zinc sulphide, ZnS, the radius ratio of 0.40 suggests a tetrahedral arrangement. Each  $\text{Zn}^{2+}$  ion is tetrahedrally surrounded by four  $\text{S}^{2-}$  and each  $\text{S}^{2-}$  is tetrahedrally surrounded by four  $\text{Zn}^{2+}$  ions. This is therefore a 4:4 arrangement since the coordination number of both ions is four.

Actually two different forms of zinc sulphide exist, both 4 : 4 arrangements, one being called zinc blende and the other wurtzite.

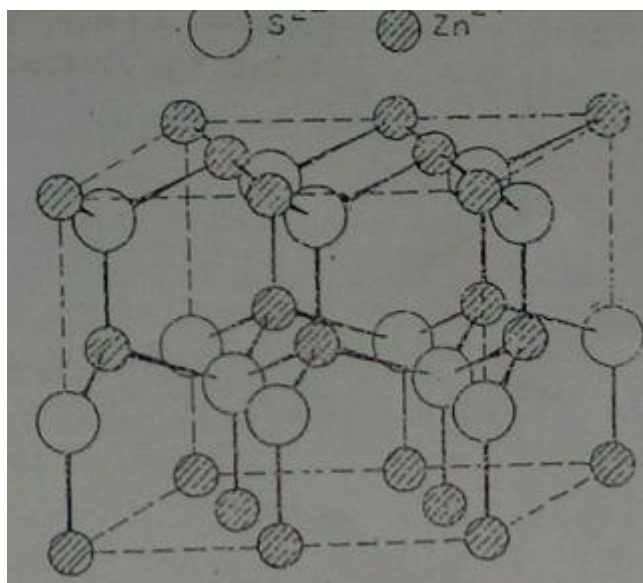

**Wurtzite (ZnS) structure**



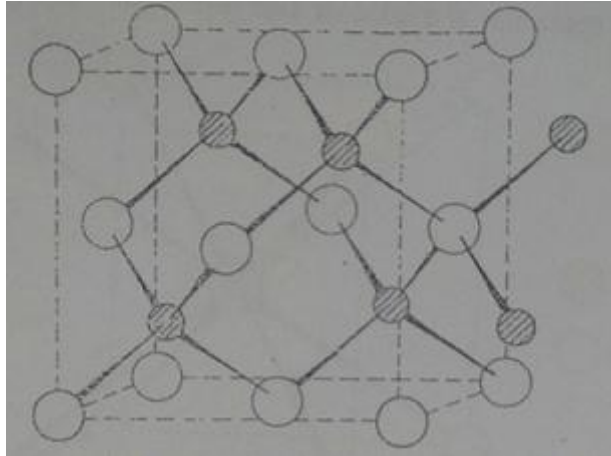

**Zinc blende (ZnS) structure**

They may be considered as close-packed arrangements of  $S^{2-}$  ions with  $Zn^{2+}$  ions occupying tetrahedral holes in the lattice. Since there are twice as many tetrahedral holes as there are  $S^{2-}$  spheres, it follows that to obtain a formula  $ZnS$  only half of the tetrahedral holes are occupied by  $Zn^{2+}$  ions (that is every alternate tetrahedral site is unoccupied).

The difference between the two forms of  $ZnS$  is that zinc blende is related to a cubic close-packed structure whilst wurtzite is related to a hexagonal close-packed structure.

### *Sodium Chloride Structure*

The radius ratio of sodium chloride, NaCl, is 0.52 and suggests an octahedral arrangement. Each  $\text{Na}^+$  ion is surrounded by six  $\text{Cl}^-$  ions at the corners of a regular octahedron and similarly each  $\text{Cl}^-$  ion is surrounded by six  $\text{Na}^+$  ions.

This structure may be regarded as having  $\text{Cl}^-$  ions occupying cubic close-packed positions, with  $\text{Na}^+$  ions in all the octahedral holes.

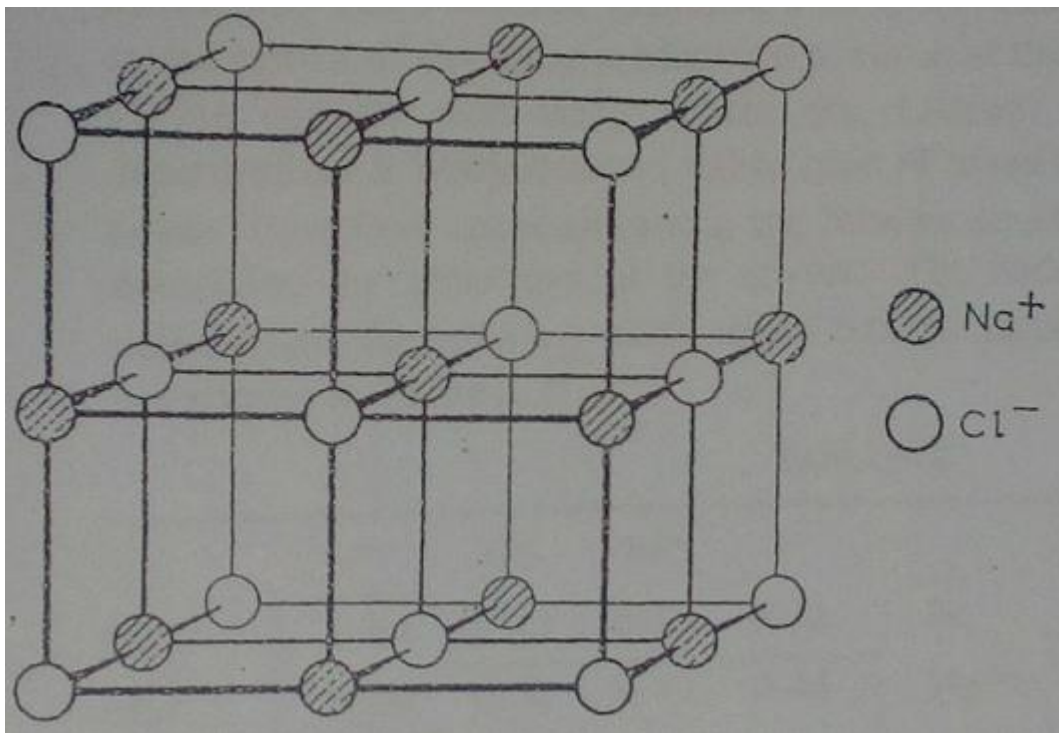

**NaCl Structure**

### *Cesium Chloride Structure*

In cesium chloride, CsCl, the radius ratio is 0.93, indicating a body-centred cubic type of arrangement, where each  $\text{Cs}^+$  ion is surrounded by eight  $\text{Cl}^-$  ions, and vice versa.

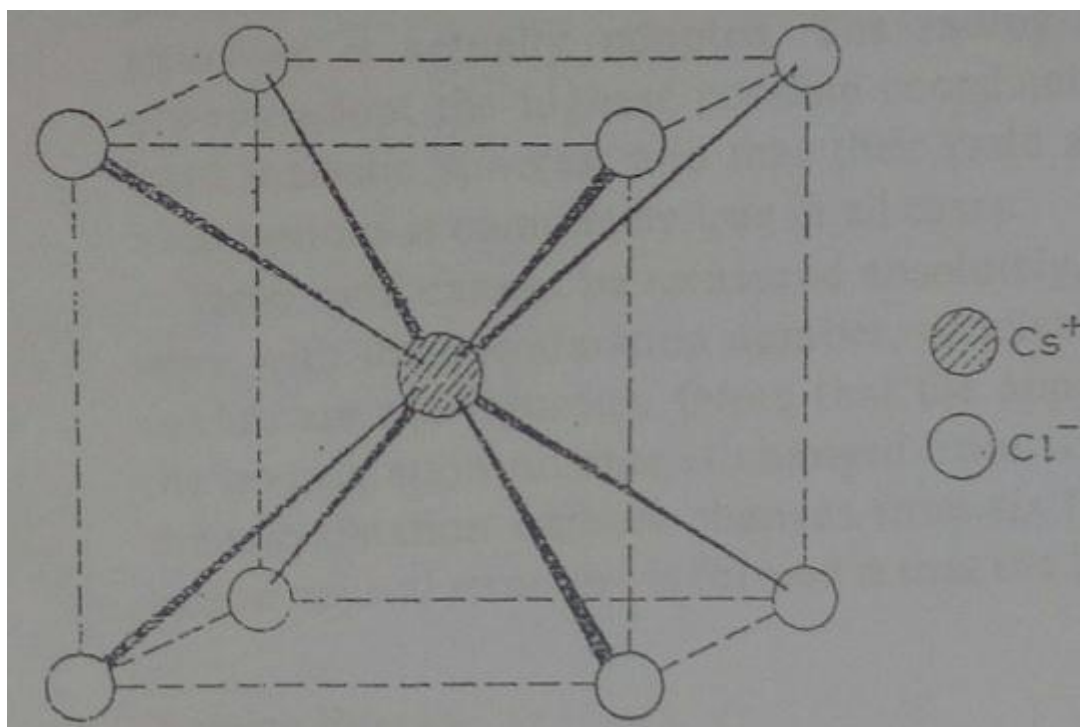

**CsCl Structure**

Note that this structure is not close packed, and it is not strictly body-centred cubic. In a body-centred cubic arrangement, the atom at the centre of the cube is identical to those at the corners. In this case the ions at the corners and body centre are different, and the structure must be described as a body-centred cubic type of arrangement and not body-centred cubic.

## Radius Ratio and Structure

The following table shows radius ratios of some of the alkali metal halides and the alkaline earth metal oxides, sulphides, selenides and tellurides.

	F <sup>-</sup>	Cl <sup>-</sup>	Br <sup>-</sup>	I <sup>-</sup>		O <sup>2-</sup>	S <sup>2-</sup>	Se <sup>2-</sup>	Te <sup>2-</sup>
Li <sup>+</sup>	0.44	0.33	0.31	0.28	Be				
Na <sup>+</sup>	0.70	0.52	0.49	0.44	Mg <sup>2+</sup>	0.46	0.35	0.33	0.29
K <sup>+</sup>	0.98	0.73	0.68	0.62	Ca <sup>2+</sup>	0.71	0.54	0.50	0.45
Rb <sup>+</sup>	0.92*	0.82	0.76	0.69	Sr <sup>2+</sup>	0.81	0.61	0.57	0.51
Cs <sup>+</sup>	0.80*	0.93	0.87	0.79	Ba <sup>2+</sup>	0.96	0.73	0.68	0.61

\* Indicates reciprocal value of  $r^-/r^+$  since the normal ratio is greater than unity.

It has been shown from the table that, except for CsCl, CsBr and CsI, which have a cesium chloride structure, and MgTe, which has a zinc sulphide structure, all the above compounds have a sodium chloride lattice at normal temperature.

Only those crystals with a radius ratio between 0.41 and 0.73 (enclosed by full line in the above table) would be expected to have the sodium chloride structure.

The difference in stability and lattice energy between coordination numbers six and eight for RbCl and RbBr is small since they have a coordination number of six at normal temperatures and pressures, but adopt the higher coordination number if crystallized at high pressures or temperatures.

Thus, radius ratios provide a useful guide to what is possible on geometrical grounds, but do not necessarily provide a reliable method for predicting which structure is actually adopted. The radius ratio concept assumes that ions always adopt the highest possible coordination number, they behave as hard inelastic

spheres, and that their radii are known exactly. None of these assumptions is completely true in all cases.

Ionic radii cannot be measured absolutely, but are estimated, and since they vary with the coordination number, conclusions based on them, though often useful, are not rigorous. (Note that the apparent ionic radius increases 3% if the coordination number is changed from six to eight and decreases 6% when the coordination number changes from six to four.

The reason why any particular crystal structure is formed is that the lattice energy is favorable.

Meanwhile, lattice energy depends on: ionic charges, crystal structure and distance between ions.

### ***Ionic Compounds of the Type AX<sub>2</sub> (CaF<sub>2</sub>, TiO<sub>2</sub>)***

There are two very common structures: fluorite, CaF<sub>2</sub>, and rutile, TiO<sub>2</sub>. Many difluorides and dioxides have one of these structures.

#### ***Fluorite Structure***

In fluorite, CaF<sub>2</sub>, each Ca<sup>2+</sup> ion is surrounded by eight F<sup>-</sup> ions in a body-centred cubic arrangement. Since there are twice as many F<sup>-</sup> ions as Ca<sup>2+</sup> ions, the coordination number of both ions is not the same, and four Ca<sup>2+</sup> ions are tetrahedrally arranged round each F<sup>-</sup> ion. The coordination numbers are eight and four and this is called an 8 : 4 arrangement.

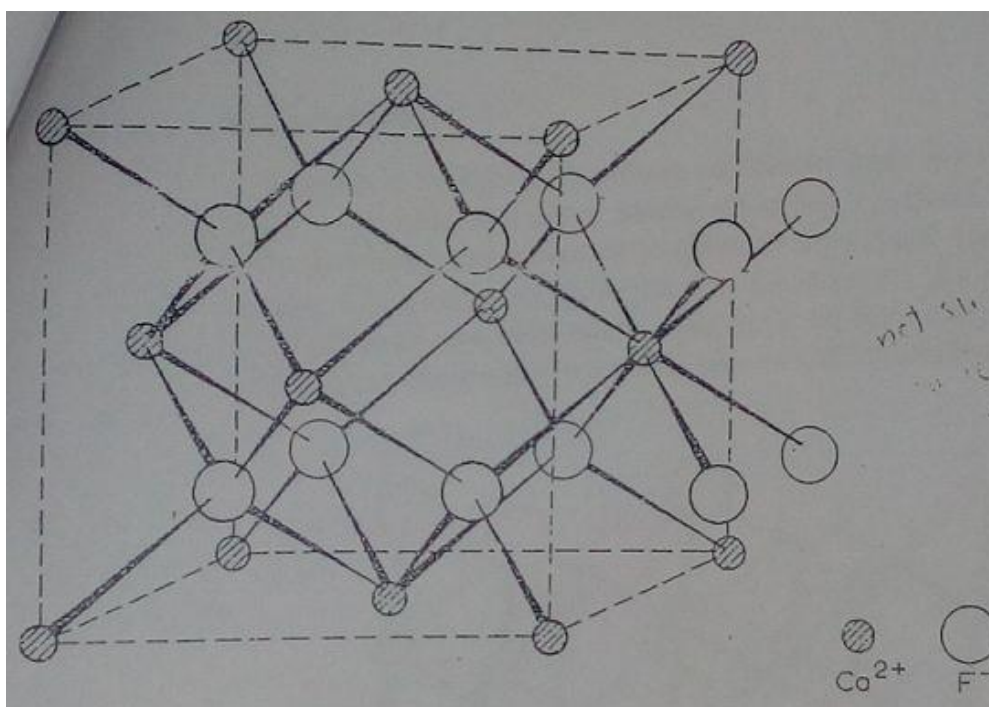

**Fluorite (CaF<sub>2</sub>) structure**

The fluorite structure is found when the radius ratio is 0.73 or above. It may be related to the close-packed structures. Though the Ca<sup>2+</sup> ions are too small to touch each other (so the structure is not strictly close packed), their relative positions are like those in a cubic close-packed structure, and the F<sup>-</sup> ions occupy all of the tetrahedral holes.

### ***Rutile Structure***

The rutile structure is found where the radius ratio is between 0.73 and 0.41.

The coordination numbers are six and three, each  $\text{Ti}^{4+}$  ion being octahedrally surrounded by six  $\text{O}^{2-}$  ions and each  $\text{O}^{2-}$  ion having three  $\text{Ti}^{4+}$  ions round it in a plane triangular arrangement.

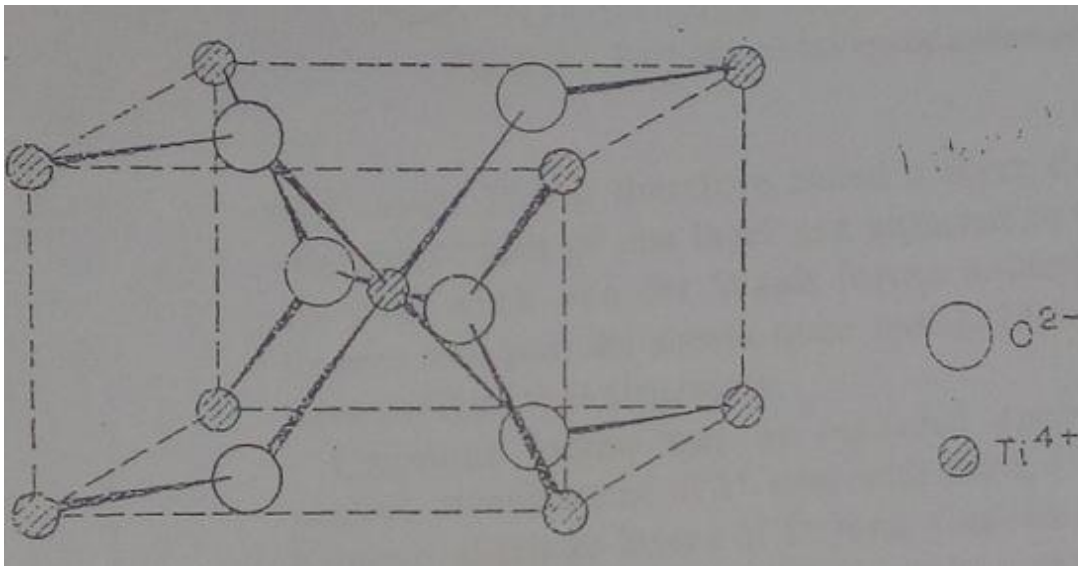

**Rutile ( $\text{TiO}_2$ ) structure**

The rutile structure is not close packed, but the  $\text{Ti}^{4+}$  ions may be considered as forming a considerably distorted body-centred cubic lattice.

There are only a few cases where the radius ratio is below 0.41, examples being silica  $\text{SiO}_2$ , and beryllium fluoride  $\text{BeF}_2$ . These have coordination numbers of four and two, but radius ratio predictions are uncertain, as they are appreciably covalent.

### ***Layer Structures***

Many AX<sub>2</sub> compounds are not sufficiently ionic to form the perfect regular ionic structures described.

Many chlorides, bromides, iodides and sulphides crystallize into structures very different from those described.

Thus cadmium iodide, CdI<sub>2</sub>, does not form the fluorite structure like CdF<sub>2</sub>. the radius ratio 0.45 indicates a coordination number of six for cadmium, but the structure is made up of electrically neutral layers of Cd<sup>2+</sup> ions sandwiched between layers of I<sup>-</sup> ions.

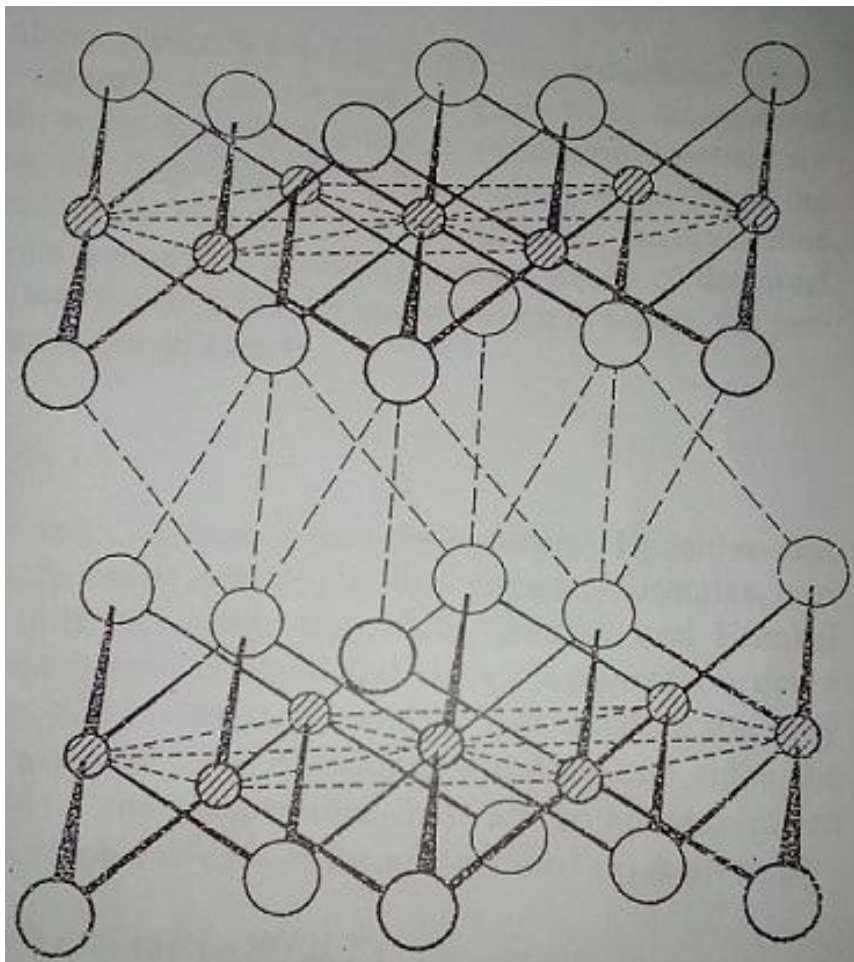

**Layer structure, (CdI<sub>2</sub>)**



This is therefore called a layer structure, and since the negatively charged  $I^-$  ions of one layer are adjacent to those of the next layer, and there are only weak van der Waals forces holding the sheets together, the crystal cleaves into parallel sheets quite easily. Most hydroxides of formula  $M(OH)_2$  have similar layer structure.

Cadmium iodide may be regarded approximately as a hexagonal close-packed arrangement of  $I^-$  ions with the  $Cd^{2+}$  ions occupying octahedral sites between alternate layers of  $I^-$  ions.

Cadmium chloride forms a closely related layer structure but with the chloride ions approximately in a cubic close-packed arrangement.

The  $CdI_2$  structure is related to the nickel arsenide NiAs structure, where the arsenic atoms form a hexagonal close-packed type of lattice with nickel atoms occupying octahedral sites between all of the layers of arsenic atoms.

Layer structures are intermediate in type between the extreme cases: (1) a totally ionic crystal with a regular arrangement of ions and strong electrostatic forces in all directions, and (2) a crystal in which small discrete molecules are held together by weak residual forces such as van der Waals forces and hydrogen bonds.

### ***Defects in Ionic Compounds***

The essential feature about crystalline solids is that the constituent molecules, atoms or ions are arranged in a completely regular three-dimensional pattern.

Models built to show the detailed structure of crystalline materials are usually grossly misleading, for they imply a perfect, static pattern. Since the atoms or ions have a considerable degree of thermal vibration, the crystalline state is far from static, and the pattern is seldom perfect.

Many of the most useful properties of solids are related to the thermal vibration of atoms, the presence of impurities or the existence of defects.

### ***Stoichiometric Defects***

In stoichiometric compounds, i.e. ones where the numbers of positive and negative ions are exactly in the ratios indicated by their chemical formulae, two types of defects may be observed. They are called Schottky and Frenkel defects.

At absolute zero, crystals tend to have a perfectly ordered arrangement. As the temperature increases, the chance that a lattice site may be unoccupied by an ion increases. This constitutes a defect, and since the number of defects depends on the temperature they are sometimes called thermodynamic defects.

The number of defects formed per  $\text{cm}^3$  ( $n$ ) is given by:

$$n = N \exp(-W/2kT)$$

where  $N$  is the number of sites per  $\text{cm}^3$  that could be left vacant,  $W$  is the work necessary to form a defect,  $k$  is the gas constant and  $T$  the absolute temperature.

### *Schottky Defects*

A pair of 'holes' exist in the crystal lattice due to one positive ion and one negative ion being absent from the crystal lattice.

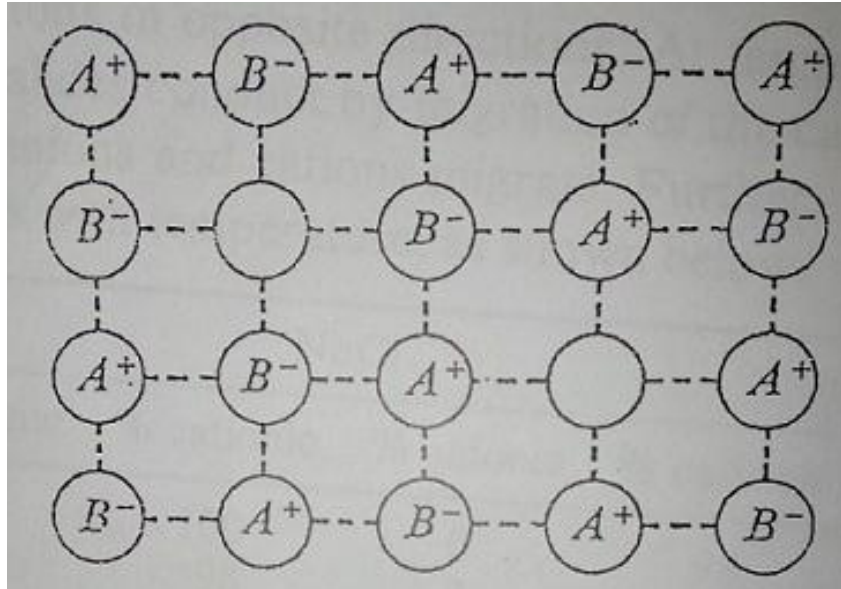

### **Schottky Defects**

This sort of defect tends to be formed in highly ionic compounds with high coordination numbers and where the positive and negative ions are of similar size, e.g. NaCl, CsCl, KCl and KBr.

### ***Frenkel Defects***

A 'hole' may exist in the lattice because an ion occupies an interstitial position rather than its correct lattice site.

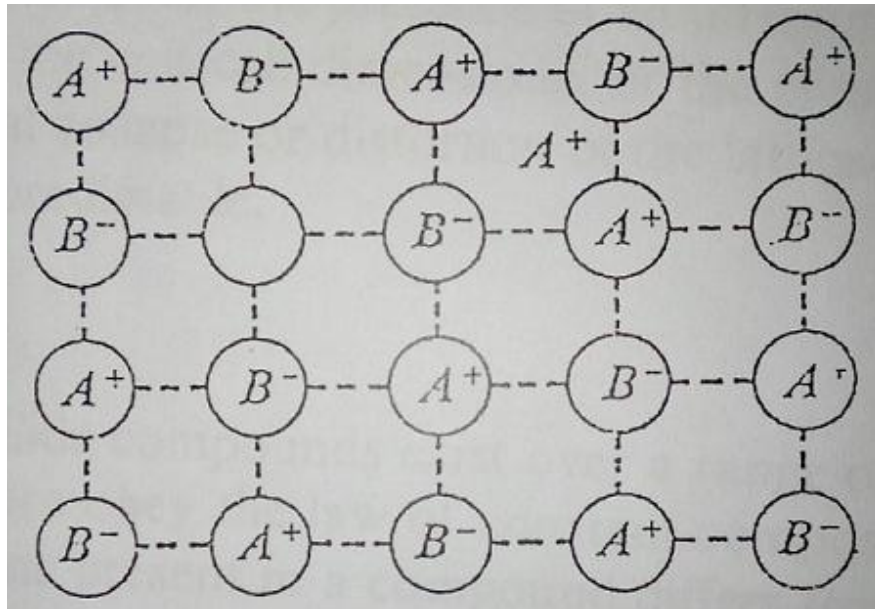

**Frenkel Defects**

This type of defect is favoured by a large difference in size between the positive and negative ions.

Since positive ions are generally smaller than negative ions, it is more common to find the positive ions occupying interstitial positions. Small positive ions are highly polarizing and large negative ions are readily polarized; hence these compounds have some covalent character. This distortion of ions, and the proximity of like charges leads to a high dielectric constant. It is easier to form Frenkel defects in compounds that have a low coordination number, since fewer attractive forces to be broken. Examples of this type of defect are ZnS, AgCl, AgBr and AgI.

The energy needed to form a Schottky defect is usually less than to form a Frenkel defect, and in a given compound one type generally predominates.

In NaCl, the energy to form a Schottky defect is about  $200 \text{ kJ mol}^{-1}$  compared with a lattice energy of approx.  $750 \text{ kJ mol}^{-1}$ . It is therefore much easier to form a defect than to break the lattice.

The number of defects is relatively small, and at room temperature NaCl has only one defect in  $10^{15}$  lattice sites, this value rising to one in  $10^6$  sites at  $500 \text{ }^\circ\text{C}$  and one in  $10^4$  sites at  $800 \text{ }^\circ\text{C}$ .

A consequence of these defects is that a crystalline solid that has defects may conduct electricity to a small extent, by an ionic mechanism. If an ion moves from its lattice site to occupy a 'hole', it creates a new 'hole', and in this way a 'hole' may migrate across a crystal, which is effectively moving a charge in the opposite direction.

In the case of Schottky defects, conduction may arise either from migration of the smaller ion only (usually the positive ion) or from migration of both type of ions in opposite directions.

At temperature bellow  $400 \text{ }^\circ\text{C}$  most of the alkali halides conduct by migration of the cations only, but at high temperatures both anions and cations migrate. Further, the amount of anionic conduction increases with temperature, as hown in the below:

°C	NaF		NaCl		NaBr	
	% cationic	% anionic	% cationic	% anionic	% cationic	% anionic
400	100	0	100	0	98	2
500	100	0	98	2	94	6
600	92	8	91	9	89	11

Frenkel defect may also give rise to ionic conduction, if the thermal vibration is sufficient to allow the interstitial ion to move to another interstitial site.

### ***Defects and Densities***

The density of a defect lattice should be lower than for a perfect lattice, because of the 'holes' present.

However, the presence of an interstitial ion may expand the lattice and increase the unit cell dimension, or the presence of too many 'holes' may allow a partial collapse or distortion of the lattice—in which case the change in density is unpredictable.

### ***Nonstoichiometric Defects***

Nonstoichiometric or Berthollide compounds exist over a range of chemical composition, and do not therefore obey the law of constant composition.

The ratio of positive and negative ions present in a compound differs from that indicated by the ideal chemical formula, and the balance of + and – charges is maintained by having either extra electrons or extra positive charges present.

This makes the structure irregular in some way, i.e. it contains defects, which are in addition to the normal thermodynamic defects already discussed. Nonstoichiometry implies that either the metal or the nonmetal atoms are present in excess.

### ***Metal Excess***

This may occur in either of two ways. In the first, a negative ion may be absent from its lattice site, having a 'hole' which is occupied by an electron, thereby maintaining the electrical balance.

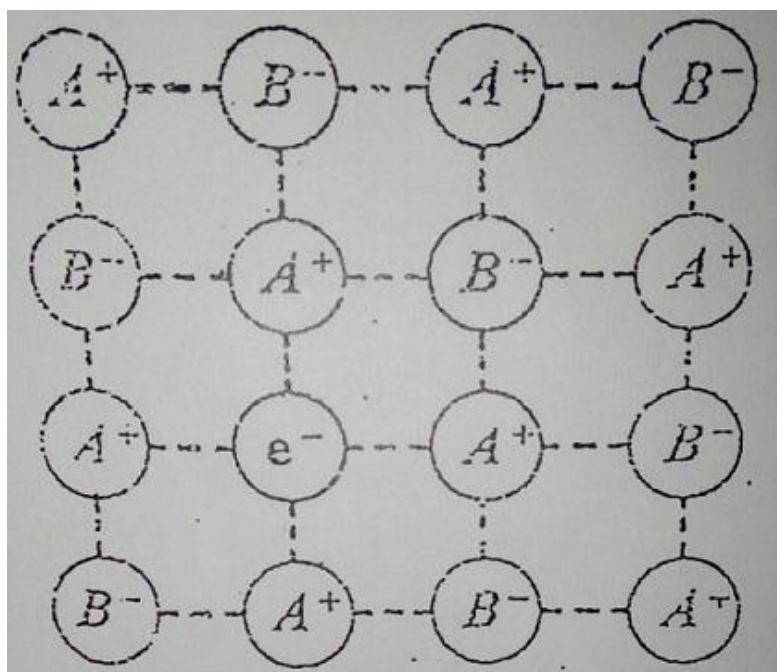

**Metal excess (Type A)**

This is rather similar to a Schottky defect in that there are 'holes' and not interstitial ions, but only one 'hole' is formed rather than a pair.

This type of defect is formed by crystals which would be expected to form Schottky defects. Examples are uncommon, but if NaCl is treated with Na vapour, a yellow nonstoichiometric form of NaCl is obtained, and a blue-coloured nonstoichiometric form of KCl may be prepared by analogous means.

The vacant sites occupied by electrons are called F-centers (or colour centers), and it is these which are associated with the colour of the compound. The more F-centers present, the greater the intensity of the colouration.

Solids containing F-centers are paramagnetic, because the electrons occupying the vacant sites are unpaired.

If materials with F-centers are irradiated with light they become photocoductors. It is though that the electrons in the F-centers absorb the light energy and become promoted into a conduction band, rather similar to the conduction bands present in metals.

A second way in which metal excess defects may occur is if an extra positive ion occupies an interstitial position in the lattice. Electrical neutrality is maintained by an electron, also in an interstitial position.



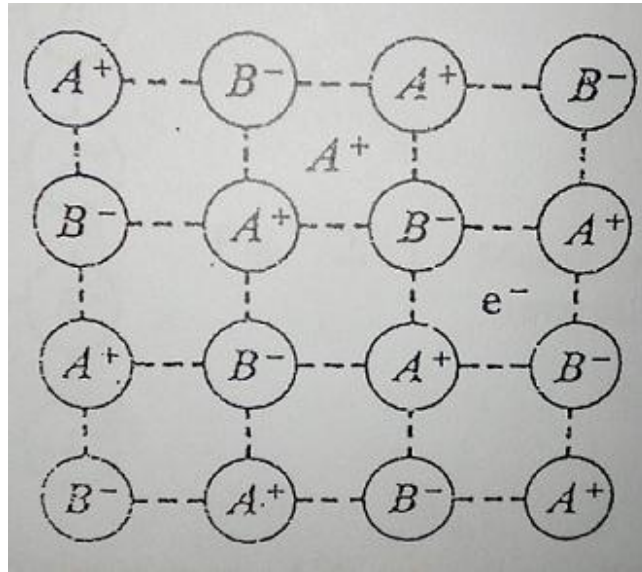

**Metal excess (Type B)**

This type of defect is rather like a Frenkel defect in that ions occupy interstitial positions, but there are no 'holes', and there are also interstitial electrons.

This second kind of metal excess defect is much more common than the first, and is formed in crystals which would be expected to form Frenkel defects, e.g. ZnO.

Crystals with either type of metal excess defect contain free electrons, and if these migrate they conduct an electric current.

Since there are relatively few defects and hence few free electrons that can conduct electricity, the amount of current carried is very small compared with that in metals, fused salts or salts in aqueous solutions, and these materials are called semiconductors.

Since the mechanism is normal electron conduction, these are called n-type semiconductors.

These free electrons may be excited to higher energy levels giving absorption spectra, and in consequence their compounds are often coloured, e.g. nonstoichiometric NaCl is yellow, nonstoichiometric KCl lilac, and ZnO is white when cold but yellow when hot.

### ***Metal Deficiency***

Theoretically metal deficiency can occur in two ways. Both require variable valency of metal, and might therefore be expected with the transition metals.

In the first way, a positive ion is absent from its lattice site, and the charges are balanced by an adjacent metal ion having two charges instead of one. Examples of this are  $\text{FeO}_2$ ,  $\text{FeS}$  and  $\text{NiO}$ .

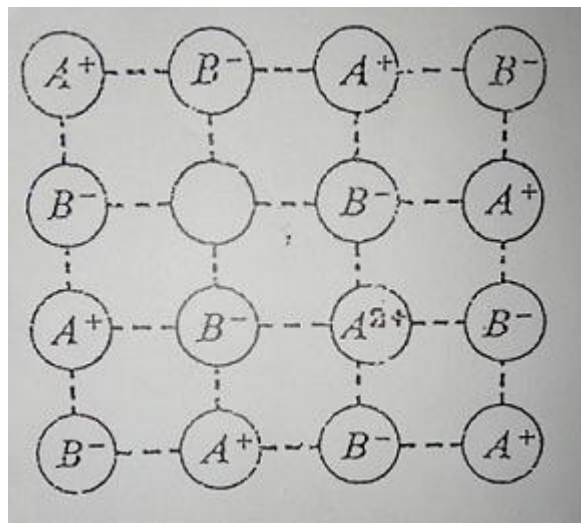

**Metal Deficiency (Type A)**

The second possibility is to have an extra negative ion in an interstitial position and to balance the charges by means of an extra charge on an adjacent metal ion. Negative ions are usually large, and it would be expected to be difficult to fit them into interstitial positions. In fact no examples of crystals containing such negative interstitial ions are known at present.

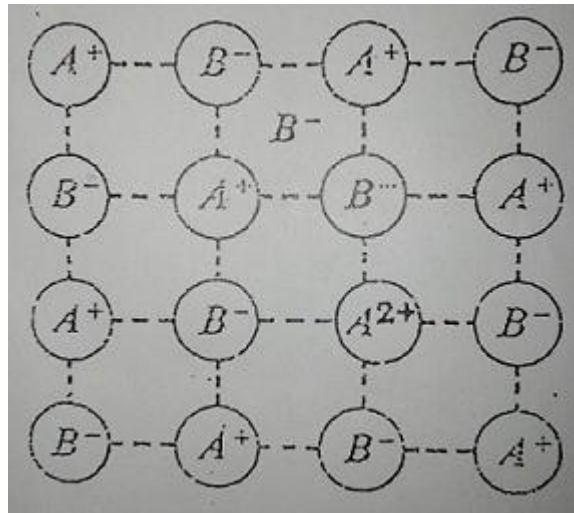

### Metal Deficiency (Type B)

Crystals with metal deficiency defects are semiconductors because of the moving of an electron from an  $A^+$  ion to an  $A^{2+}$  ion, i.e. an apparent movement of  $A^{2+}$ . This is called positive hole, or p-type semiconduction.

**References:**

1- J.D. LEE; A New Concise Inorganic Chemistry, 3<sup>rd</sup> Edition, Chapman and Hall, London, 1977

2- William W. Porterfield; Concepts of Chemistry, 1<sup>st</sup> Edition, W. W. Norton & Company Inc., New York, 1972