



جامعة جنوب الوادي
South Valley University



PLANT KINGDOM

FOR 1ST YEAR STUDENTS

FACULTY OF SCIENCE

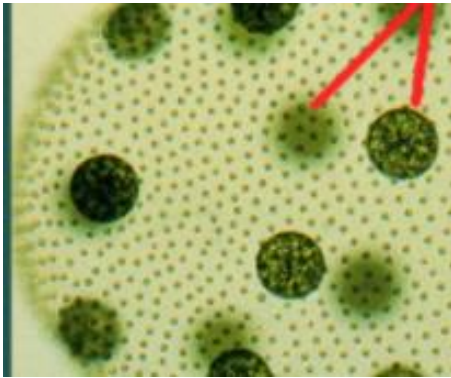

BY

*STAFF MEMBERS OF
BOTANY & MICROBIOLOGY DEPARTMENT*

Dr/ Asmaa Sayed



رؤية ورسالة الكلية

رؤية الكلية

التميز في تعليم العلوم الأساسية والبحث العلمي للمساهمة في التنمية المستدامة.

رسالة الكلية

تقديم تعليم مميز في مجالات العلوم الأساسية وإنتاج بحوث علمية تطبيقية للمساهمة في التنمية المستدامة من خلال إعداد خريجين متميزين طبقاً للمعايير الأكاديمية القومية، وتطوير مهارات وقدرات الموارد البشرية، وتوفير خدمات مجتمعية وبيئية تلبي طموحات مجتمع جنوب الوادي، وبناء الشراكات المجتمعية الفاعلة.

How do we classify the living world?

Life used to be simple! Early scientists classified organisms as either Animal or Plant. Animals moved, had nervous systems and showed heterotrophic nutrition, among other features. Plants, in contrast, were photosynthetic with a cell wall enclosing the cytoplasm. Bacteria and fungi aren't usually photosynthetic but as they have cell walls they were looked upon as being plant-like. (We now know their cell walls are really quite different.) In this simple system of plants and animals, "plants" which had no recognizable shoot/root/leaf regions were said to have a body termed a **thallus** and were termed Thallophytes. In this earliest classification system bacteria, fungi and algae were all put into this grouping.

There is, however, a more fundamental divide than all that. We now know that based on cell structure we can divide organisms into prokaryotes and eukaryotes. The eukaryotic cells (plants, animals and fungi) have a nucleus, internal membrane systems (i.e. organelles like mitochondria) and distinctive 80S ribosomes. The bacteria show the radically different prokaryotic organization without internal membranes, with naked DNA in place of a nucleus, with 70S ribosomes and with different flagellar structure.

Today we recognize;-

Monera (Prokaryotes) - with their radically different cell structure, namely the bacteria including the blue-green bacteria (once called blue-green algae).

Plants - photosynthetic (mainly terrestrial) eukaryotes with cell walls

Animals - motile, heterotrophic eukaryotes, the cells of which are not surrounded by cell walls.

Fungi - non-motile, cell wall-bound, spore-bearing eukaryotes with a saprophytic or parasitic mode of heterotrophic nutrition

A fifth kingdom is also recognized by many scientists;-

Protista - defined really as none of the above! It comprises eukaryotic microorganisms and their immediate descendants, viz. protozoa, slime molds, algae.

(Cavalier-Smith, 2004) proposes a **Six Kingdom System**

Prokaryote Empire

Bacterial Kingdom

With their radically different cell structure, including the blue-green bacteria (once called blue-green algae).

Eukaryote Empire

Plant Kingdom - all land plants as well as green and red algae

Animal Kingdom - motile, heterotrophic eukaryotic organisms, the cells of which are not surrounded by cell walls

Fungal Kingdom - non-motile, cell wall-bound, spore-bearing eukaryotes with a saprophytic or parasitic mode of heterotrophic nutrition

Protozoan Kingdom- eukaryotic, motile unicells

Chromista Kingdom - includes brown algae, golden algae, yellow-green algae, diatoms, water molds.

The question is **How Many Kingdoms?**

Many botanists have a problem with the idea that algae, especially green algae, are not considered plants. This six kingdom system at least places green algae within the plant kingdom. In this course, we will not worry too much about classification systems and will focus on green algae and survey other major algal groups in order to get a better understanding of how land plants evolved.

What is a plant?

All the features of plants can readily be understood in the context of their autotrophic mode of nutrition. If plants simply transform light energy into chemical energy then all that is required is for the plant to be anchored firmly in one place with a maximum surface area to capture sunlight. There is no need for plants to move or to have sophisticated nervous

systems such as animals need to enable them to find food. The earth today is dominated by the flowering plants. Our purpose in this course is to understand how these flowering plants came into being. We can only understand this by studying the plant groups that came before. This course is, therefore, a brief survey of the plant kingdom from an evolutionary perspective.

Botanical nomenclature:

Is the formal, scientific naming of plants. It has a long history, going back to the period when Latin was the scientific language throughout Europe, and perhaps further back to Theophrastos. The key event was Linnaeus' adoption of binary names for plant species in his *Species Plantarum* (1753). This gave every plant species a name that remained the same no matter what other species were placed in the genus, and thus separated taxonomy from nomenclature. These species names of Linnaeus together with names for other ranks, notably the rank of family (not used by Linnaeus), can serve to express a great many taxonomic viewpoints.

In the nineteenth century it became increasingly clear that there was a need for rules to govern scientific nomenclature, and initiatives were taken to produce a body of laws. These were published in successively more sophisticated editions.

For plants the key dates are 1867 (*lois de Candolle*), 1906 (*International Rules of Botanical Nomenclature*, 'Vienna Rules') and 1952 (*International Code of Botanical Nomenclature*, 'Stockholm Code').

Another development was the insight into the delimitation of the concept of 'plant'. Linnaeus held a much wider view of what a plant is than is acceptable today. Gradually more and more groups of organisms are being recognized as being independent of plants. Nevertheless the formal names of most of these organisms are governed by the *International Code of Botanical Nomenclature (ICBN)*, even today. A separate *Code* was adopted to govern the nomenclature of Bacteria, the *ICNB*.

Relationship to taxonomy

Botanical nomenclature is closely linked to plant taxonomy, and botanical nomenclature serves plant taxonomy, but nevertheless botanical nomenclature is separate from plant taxonomy. Botanical nomenclature is merely the body of rules prescribing which name applies to that taxon (see correct name) and if a new name may (or must) be coined.

Plant taxonomy is an empirical science, a science that determines what constitutes a particular taxon (taxonomic

grouping, plural: taxa): e.g. "What plants belong to this species?" and "What species belong to this genus?").

PLANT CLASSIFICATION SYSTEMS

There are several plant classification systems and little agreement, e.g. some botanists believe the ferns are a class within the Division Pteridophyta, others consider them a division of their own. In this course, rather than use a formal classification system we will simply refer to these groups by their informal names;-

Algae, Bryophytes, Pteridophytes, Gymnosperms and Angiosperms.

There are a few other higher categories of classification you may come across in your reading.

Lower plants usually include algae and Bryophytes, while **higher plants** refer to Pteridophytes, Gymnosperms and Angiosperms.

The word **Cryptogams** literally means "hidden wedding" and alludes to the fact that the sex life of these plants (algae, Bryophytes and Pteridophytes) was once not understood. **Phanerogams** ("open wedding") are the seed plants - the gymnosperms and angiosperms.

Thallophytes is an outmoded term for plants whose body is not differentiated into root/stem/leaves but is termed a

thallus. Algae fall into this category (and fungi did too when they were considered to be plants).

Vascular plants are those with vascular tissue (xylem & phloem). **Embryophytes** (all but algae) are plants that bear an embryo and are synonymous with **land plants**.

VIRUSES

Viruses are basically a way a *form of genetic information* insures its continued survival. They are entities which reproduces their DNA/RNA within living cells utilizing mechanisms of cells for this.

VIRUS HISTORY

In 1884 C. Chamberland, in Pasteur's lab, discovered that if you passed a liquid containing bacteria through an unglazed PORCELAIN tube, the bacteria were **COMPLETELY RETAINED** and the solution that passed through (the **FILTRATE**) was sterile. The advantages of this tool were immediately apparent, for with it one could sterilize solutions containing heat-sensitive components by filtration through sterile porcelain tubes into sterile containers. By carefully controlling the components of the porcelain tubes you could

CONTROL THE PORE SIZE and selectively remove larger organisms while letting smaller ones pass through.

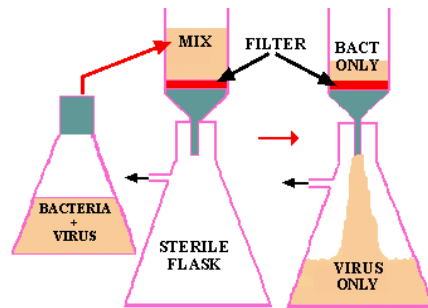

Figure 1. Filtration of a mixture of bacteria and viruses.

If a mixture of viruses and bacteria are filtered through a bacterial-proof filter (**red**), the viruses will pass through into the filtrate in the flask. Filtered beer is produced by a similar process.

This type of filtration immediately became one means of testing the Germ Theory, since if you passed an infected sample through a filter that would hold back all microbes, the filtrate should not induce the disease in a new host if a microbe was responsible. You could then begin to devise ways of growing the suspected pathogen. However, in 1892 D. IWANOWSKI applied this test to a filtrate of plants suffering from **TOBACCO MOSAIC DISEASE** with shocking results; the filtrate was **FULLY CAPABLE** of producing the **ORIGINAL DISEASE** in new hosts. When

repeated, filtrations produced the same results and nothing could be seen in the filtrates using the most powerful microscopes, nor could anything be cultivated from the filtrates, Iwanowski and associates concluded that they had discovered a new pathogenic life-form which they called by the unimaginative, but functional, name of "**FILTERABLE VIRUS**".

Viruses are smaller and less complex than bacteria. As science became aware of the role of the viruses in human disease, the techniques of bacteriology were modified to accommodate the viruses and the discipline of virology grew up within bacteriology. Because of this, we will begin this unit on viruses with bacteriophages, the viruses that infect bacterial cells. Animal viruses will be dealt with separately. But the lessons learned from the replication events of the bacteriophages will be directly applied to understanding the replication of viruses such as Herpes and HIV.

Size

To put viral size into perspective, a medium sized virion next to a flea is roughly equivalent to a human next to a mountain twice the size of Mount Everest. Some filoviruses have a total length of up to 1400 nm, however their capsid diameters are only about 80 nm. The majority of viruses which have

been studied have a capsid diameter between 10 and 300 nanometres. While most viruses are unable to be seen with a light microscope, More commonly, both scanning and transmission electron microscopes are used to visualize virus particles.

Principles of Virus Architecture

Viruses are not plants, animals, or bacteria, but they are the quintessential parasites of the living kingdoms. Although they may seem like living organisms because of their prodigious reproductive abilities, viruses are not living organisms in the strict sense of the word.

Without a host cell, viruses cannot carry out their life-sustaining functions or reproduce. They cannot synthesize proteins, because they lack ribosomes and must use the ribosomes of their host cells to translate viral messenger RNA into viral proteins. Viruses cannot generate or store energy in the form of adenosine triphosphate (ATP), but have to derive their energy, and all other metabolic functions, from the host cell. They also parasitize the cell for basic building materials, such as amino acids, nucleotides, and lipids (fats). Although viruses have been speculated as being a form of protolife, their inability to survive without living organisms makes it highly unlikely that they preceded cellular life

during the Earth's early evolution. Some scientists speculate that viruses started as rogue segments of genetic code that adapted to a parasitic existence.

All viruses contain nucleic acid, either DNA or RNA (but not both), and a protein coat, which encases the nucleic acid. Some viruses are also enclosed by an envelope of fat and protein molecules. In its infective form, outside the cell, a virus particle is called a virion. Each virion contains at least one unique protein synthesized by specific genes in its nucleic acid. Viroids (meaning "viruslike") are disease-causing organisms that contain only nucleic acid and have no structural proteins. Other viruslike particles called prions are composed primarily of a protein tightly integrated with a small nucleic acid molecule.

Viruses are generally classified by the organisms they infect, animals, plants, or bacteria. Since viruses cannot penetrate plant cell walls, virtually all plant viruses are transmitted by insects or other organisms that feed on plants. Certain bacterial viruses, such as the T4 bacteriophage, have evolved an elaborate process of infection. The virus has a "tail" which it attaches to the bacterium surface by means of proteinaceous "pins." The tail contracts and the tail plug penetrates the cell wall and underlying membrane, injecting the viral nucleic acids into the cell. Viruses are further

classified into families and genera based on three structural considerations: 1) the type and size of their nucleic acid, 2) the size and shape of the capsid, and 3) whether they have a lipid envelope surrounding the nucleocapsid (the capsid enclosed nucleic acid).

There are predominantly two kinds of shapes found amongst viruses: rods, or filaments, and spheres. The rod shape is due to the linear array of the nucleic acid and the protein subunits making up the capsid. The sphere shape is actually a 20-sided polygon (icosahedron).

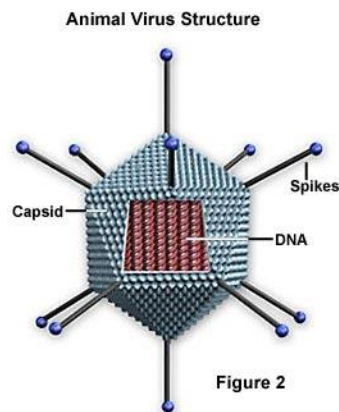

- **Capsid** - The capsid is the protein shell that encloses the nucleic acid; with its enclosed nucleic acid, it is called the nucleocapsid. This shell is composed of protein organized in subunits known as capsomers. They are closely associated with the nucleic acid and reflect its configuration, either a rod-shaped helix or a polygon-shaped sphere. The capsid has

three functions: 1) it protects the nucleic acid from digestion by enzymes, 2) contains special sites on its surface that allow the virion to attach to a host cell, and 3) provides proteins that enable the virion to penetrate the host cell membrane and, in some cases, to inject the infectious nucleic acid into the cell's cytoplasm. Under the right conditions, viral RNA in a liquid suspension of protein molecules will self-assemble a capsid to become a functional and infectious virus.

- **Envelope** - Many types of virus have a glycoprotein envelope surrounding the nucleocapsid. The envelope is composed of two lipid layers interspersed with protein molecules (lipoprotein bilayer) and may contain material from the membrane of a host cell as well as that of viral origin. The virus obtains the lipid molecules from the cell membrane during the viral budding process. However, the virus replaces the proteins in the cell membrane with its own proteins, creating a hybrid structure of cell-derived lipids and virus-derived proteins. Many viruses also develop spikes made of glycoprotein on their envelopes that help them to attach to specific cell surfaces.

- **Nucleic Acid** - Just as in cells, the nucleic acid of each virus encodes the genetic information for the synthesis of all proteins. While the double-stranded DNA is responsible for this in prokaryotic and eukaryotic cells, only a few groups of

viruses use DNA. Most viruses maintain all their genetic information with the single-stranded RNA. There are two types of RNA-based viruses. In most, the genomic RNA is termed a plus strand because it acts as messenger RNA for direct synthesis (translation) of viral protein. A few, however, have negative strands of RNA. In these cases, the virion has an enzyme, called RNA-dependent RNA polymerase (transcriptase), which must first catalyze the production of complementary messenger RNA from the virion genomic RNA before viral protein synthesis can occur.

Table 1. General Features of Viruses

1. small size

cannot be viewed with a light microscope

pass through filters that retain bacteria

range of size = 0.1-0.3 micrometers

2. characteristic shapes - spherical (complex), helical, rod or polyhedral, sometimes with tails or envelopes. Most common polyhedron is the icosahedron which has 20 triangular faces.

3. obligate intracellular parasites Viruses do not contain within their coats the machinery for replication. For this they

depend upon a host cell and this accounts for their existence as obligate intracellular parasites. Each virus can only infect certain species of cells. This refers to the virus **host range**.

4. **no built-in metabolic machinery** Viruses have no metabolic enzymes and cannot generate their own energy.

5. **no ribosomes** Viruses cannot synthesize their own proteins. For this they utilize host cell ribosomes during replication. Features 4 and 5 account for the obligate intracellular parasitism of viruses.

6. **only one type of nucleic acid** Viruses contain either DNA or RNA (never both) as their genetic material. The nucleic acid can be single-stranded or double stranded.

7. **do not grow in size** Unlike cells, viruses do not grow in size and mass leading to a division process. Rather viruses grow by separate synthesis and assembly of their components resulting in production of a "crop" of mature viruses.

Viral Classification and Replication:

How are viruses classified?

Hierarchical virus classification:

Order - family - subfamily - genus - species - strain/type

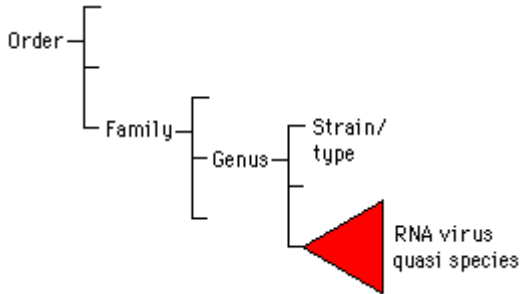

At the moment classification is really only important from the level of families down. All families have the suffix **viridae** e.g.

- Poxviridae
- Herpesviridae
- Parvoviridae
- Retroviridae

Members of the family Picornaviridae are generally transmitted via the faecal/oral and airborne routes.

The Bacteriophages

Viruses that attack bacteria were observed by Twort and d'Herelle in 1915 and 1917. They observed that broth cultures of certain intestinal bacteria could be dissolved by addition of a bacteria-free filtrate obtained from sewage. The lysis of the bacterial cells was said to be brought about by a **virus** which meant a "filterable poison" ("virus" is Lat. for "poison").

Probably every known bacterium is subject to one or more viruses or "**bacteriophages**" as they are known ("phage" for short, from Gr. "phagein" meaning "to eat" or "to nibble"). Most research has been done on the phages that attack *E. coli*, especially the T-phages and phage lambda.

Like all viruses, the bacteriophages carry only the genetic information needed for replication of their nucleic acid and synthesis of their protein coats. When phages infect their host cell, the order of business is to replicate their nucleic acid and to produce the protective protein coat. But they cannot do this alone. They require precursors, energy generation and ribosomes supplied by their host cell.

Bacterial cells can undergo one of two types of infections by viruses termed **lytic infections** and **lysogenic (temperate) infections**. In *E. coli*, lytic infections are caused by a group seven phages known as the T-phages, while lysogenic infections are caused by the phage lambda.

Lytic Infections The T-phages, T1 through T7, are referred to as lytic phages because they always bring about the lysis and death of their host cell, the bacterium *E. coli*. T-phages contain double-stranded DNA as their genetic material. In addition to their protein coat or capsid (also referred to as the "head"), T-phages also possess a tail and some related structures. A diagram and electron micrograph of

bacteriophage T4 is shown below. The tail includes a core, a tail sheath, base plate, tail pins, and tail fibers, all of which are composed of different proteins. The tail and related structures of bacteriophages are generally involved in attachment of the phage and securing the entry of the viral nucleic acid into the host cell.

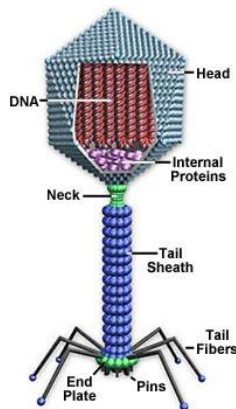

Figure 5. Bacteriophage structure.

This is a large bacteriophage. It happens to be one of the most complex viruses. Not all phage are large; some are composed of only 7 genes. This is an *E. coli* Model of phage T4. The phage possesses a genome of linear ds DNA contained within an icosahedral head. The tail consists of a hollow core through which the DNA is injected into the host cell. The tail fibers are involved with recognition of specific viral "receptors" on the bacterial cell surface.

Before viral infection the cell is busy replicating its own DNA and transcribing its own genetic information to carry out biosynthesis, growth and cell division. After infection, the viral DNA takes over the biosynthetic machinery of the host cell and uses it to produce the parts needed for production of new virus particles. Viral DNA replaces the

host cell DNA as a template for both replication (to produce more viral DNA) and transcription (to produce viral mRNA). Viral mRNAs are then translated, using host cell ribosomes, tRNAs and amino acids, into viral proteins such as the coat proteins. The process of DNA replication, synthesis of proteins, and viral assembly is a carefully coordinated and timed event. The overall process of lytic infection is diagrammed in the figure below. Discussion of the specific steps follows.

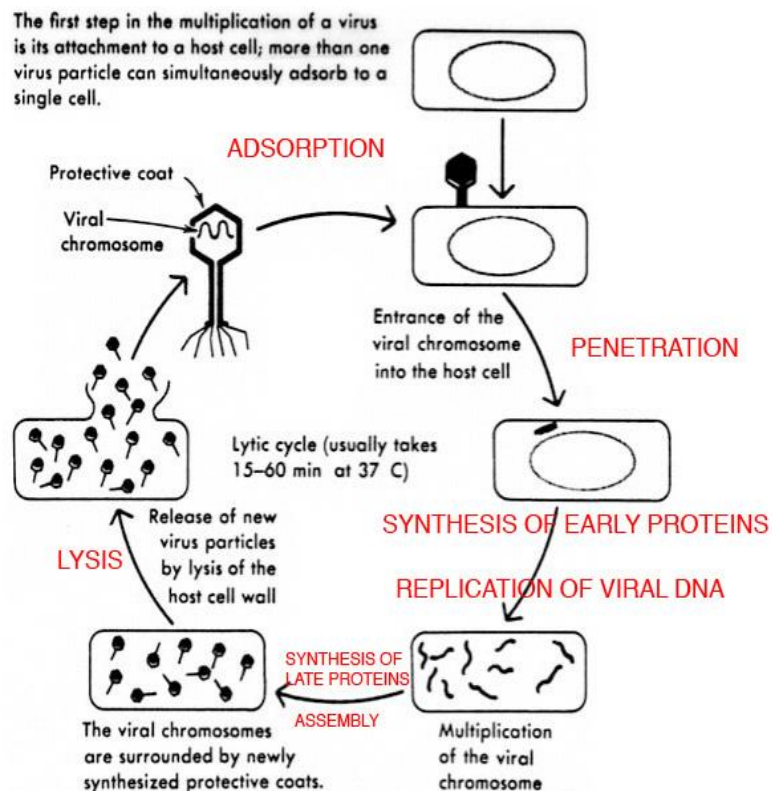

Figure 6. The lytic cycle of a bacterial virus.

The first step in the replication of the phage in its host cell is called **adsorption**. The phage particle undergoes a chance

collision at a chemically complementary site on the bacterial surface, then adheres to that site by means of its tail fibers. Following adsorption, the phage injects its DNA into the bacterial cell. The tail sheath contracts and the core is driven through the wall to the membrane. This process is called **penetration** and it may be either mechanical or enzymatic. In the latter case, phage T4 packages a bit of lysozyme in the base of its tail from a previous infection and then uses the lysozyme to degrade a portion of the bacterial cell wall for insertion of the tail core. The DNA is injected into the periplasm of the bacterium, and generally it is not known how the DNA penetrates the membrane. The adsorption and penetration processes are illustrated below.

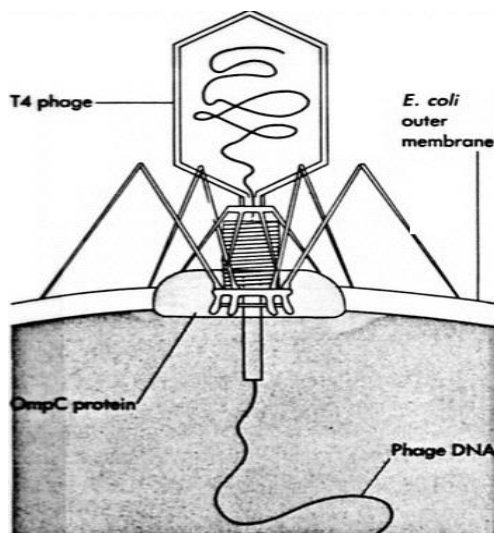

Figure 7. Adsorption, penetration and injection of bacteriophage T4 DNA into an *E. coli* cell. T4 attaches to the outer membrane ompC.

Immediately after injection of the viral DNA there is a process initiated called **synthesis of early proteins**. This refers to the transcription and translation of a section of the phage DNA to make a set of proteins that are needed to replicate the phage DNA. Among the **early proteins** produced are a repair enzyme to repair the hole in the bacterial cell wall, a DNAase enzyme that degrades the host DNA into precursors of phage DNA, and a virus specific DNA polymerase that will copy and replicate phage DNA. During this period the cell's energy-generating and protein-synthesizing abilities are maintained, but they have been subverted by the virus. The result is the synthesis of several copies of the phage DNA.

The next step is the **synthesis of late proteins**. Each of the several replicated copies of the phage DNA can now be used for transcription and translation of a second set of proteins called the **late proteins**. The late proteins are mainly structural proteins that make up the capsomeres and the various components of the tail assembly. Lysozyme is also a late protein that will be packaged in the tail of the phage and be used to escape from the host cell during the last step during the replication process.

Having replicated all of their parts, there follows an **assembly** process. The proteins that make up the

capsomeres assemble themselves into the heads and "reel in" a copy of the phage DNA. The tail and accessory structures assemble and incorporate a bit of lysozyme in the tail plate. The viruses arrange their escape from the host cell during the assembly process.

While the viruses are assembling, lysozyme is being produced as a late viral protein. Part of this lysozyme is used to escape from the host cell by lysing the cell wall peptidoglycan from the inside. This accomplishes the **lysis of the host cell and the release of the viruses**, which spread to nearby cells, infect them, and complete the cycle. The life cycle of a T-phage takes about 25-35 minutes to complete. Because the host cells are ultimately killed by lysis, this type of viral infection is referred to a **lytic infection**.

Lysogenic Infections

Lysogenic or temperate infection rarely results in lysis of the bacterial host cell. Lysogenic viruses, such as lambda which infects *E. coli*, have a different strategy for their replication. After penetration, the virus DNA integrates into the bacterial chromosome and it becomes replicated every time the cell duplicates its chromosomal DNA during normal cell division. The live cycle of a lysogenic bacteriophage is illustrated below.

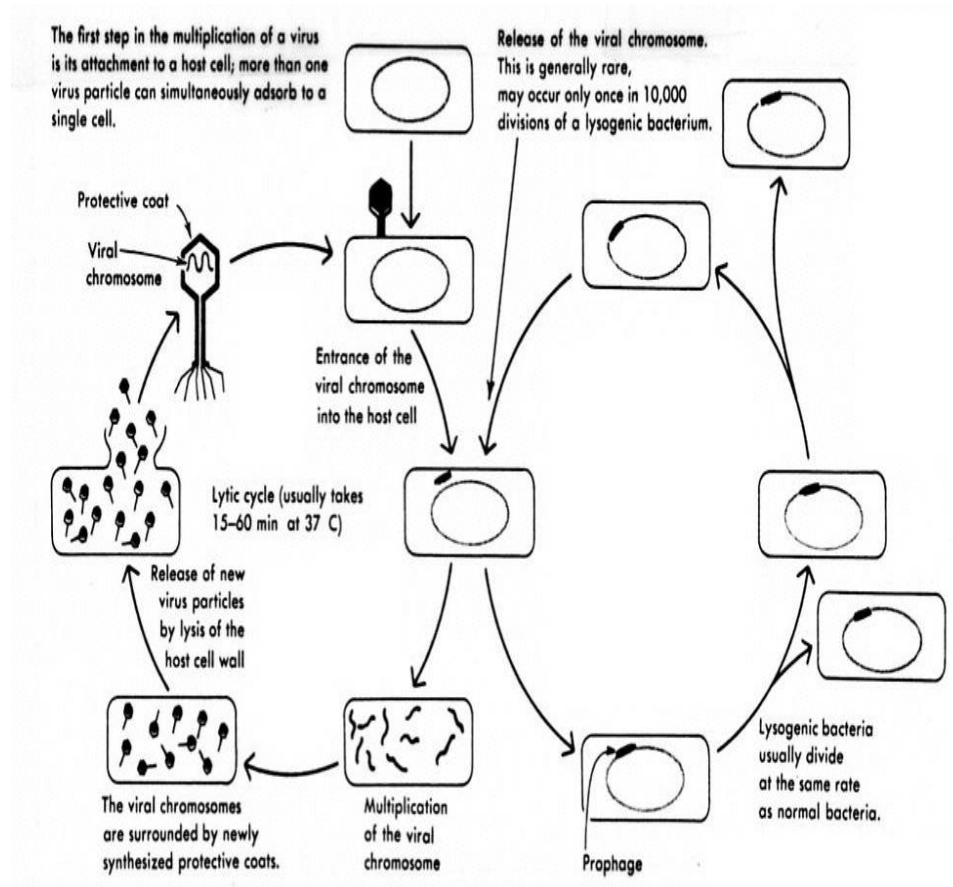

Figure 8. The lysogenic cycle of a bacterial virus.

Temperate viruses usually do not kill the host bacterial cells they infect. Their chromosome becomes integrated into a specific section of the host chromosome. These bacteria are called **lysogenic**. The virus in this state is called **prophage**. In the prophage state all the phage genes except one are repressed. None of the usual early proteins or structural proteins are formed.

LECTURE (2)
Kingdom Monera
BACRETTIA

The Scope of Bacteriology

The Bacteria are a group of single-cell microorganisms with **prokaryotic** cellular configuration. The genetic material (DNA) of procaryotic cells exists unbound in the cytoplasm of the cells. There is **no nuclear membrane**, which is the definitive characteristic of eucaryotic cells such as those that make up plants and animals. Until recently, bacteria were the only known type of procaryotic cell, and the discipline of biology related to their study is called **bacteriology**.

Bacteria grow in a wide variety of habitats and conditions.

Bacteria are so widespread that it is possible only to make the most general statements about their life history and ecology. They may be found on the air, soil, water, your body and also on the tops of mountains, the bottom of the deepest oceans, in the guts of animals, and even in the frozen rocks and ice of Antarctica. One feature that has enabled them to spread so far, and last so long is their ability to go dormant for an extended period.

Structure and function of prokaryotic cells

Procaryotes are unicellular organisms of relatively simple construction, especially if compared to eukaryotes. Whereas eukaryotic cells have a preponderance of organelles with separate cellular functions, procaryotes carry out all cellular functions as individual units. A procaryotic cell has five essential structural components: a **genome (DNA)**, **ribosomes**, **cell membrane**, **cell wall**, and some sort of **surface layer** which may or may not be an inherent part of the wall.

At one time it was thought that bacteria were essentially "bags of enzymes" with no inherent cellular architecture. The development of the electron microscope, in the 1950s, revealed the distinct anatomical features of bacteria and confirmed the suspicion that they lacked a nuclear membrane. Structurally, a procaryotic cell (Figure 1) has three architectural regions: **appendages** (attachments to the cell surface) in the form of **flagella** and **pili (or fimbriae)**; a **cell envelope** consisting of a **capsule**, **cell wall** and **plasma membrane**; and a **cytoplasmic region** that contains the cell **genome (DNA)** and **ribosomes** and various sorts of **inclusions**.

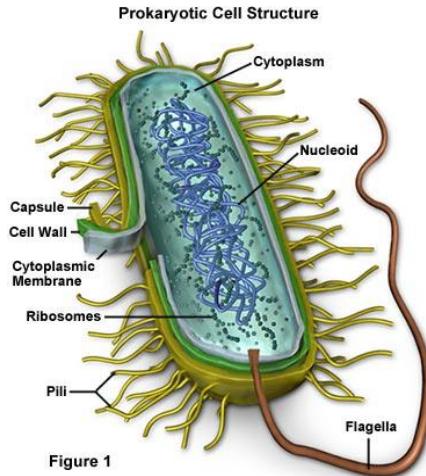

Figure 1. Schematic drawing of a typical bacterium.

- **Cell Wall** - Outer covering of the cell that protects the bacterial cell and gives it shape.
- **Cytoplasm** - A gel-like substance composed mainly of water that also contains enzymes, salts, cell components, and various organic molecules.
- **Cell Membrane or Plasma Membrane** - Surrounds the cell's cytoplasm and regulates the flow of substances in and out of the cell.
- **Flagella** - Long, whip-like protrusion that aids in cellular locomotion.
- **Ribosomes** - Cell structures responsible for protein production.
- **Plasmids** - Gene carrying, circular DNA structures that are not involved in reproduction.

- **Nucleoid Region** - Area of the cytoplasm that contains the single bacterial DNA molecule.

Bacteria: Systematics

Bacterial cells almost invariably take one of three forms: rod (**bacillus**), sphere (**coccus**), or spiral (**spirilla** and **spirochetes**). Rods that are curved are called **vibrios**. Fixed bacterial cells stain either Gram-positive (purple) or Gram-negative (pink); motility is easily determined by observing living specimens. Bacilli may occur singly or form chains of cells; cocci may form chains (**streptococci**) or grape-like clusters (**staphylococci**); spiral shape cells are almost always motile; cocci are almost never motile. This nomenclature ignores the **actinomycetes**, a prominent group of branched bacteria which occur in the soil. But they are easily recognized by their colonies and their microscopic appearance.

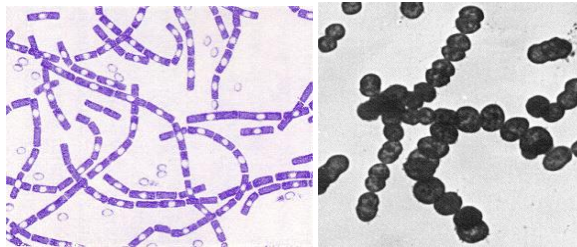

A

B

Figure 2A. Gram stain of *Bacillus anthracis*, the cause of anthrax. B) Chains of dividing streptococci. Electron micrograph of *Streptococcus pyogenes*.



Figure 3. Spirochetes: A. Cross section of a spirochete showing the location of endoflagella between the inner membrane and outer sheath; B. *Borrelia burgdorferi*, the agent of Lyme disease; C. *Treponema pallidum*, the spirochete that causes syphilis.

Such easily-made microscopic observations, combined with knowing the natural environment of the organism, are important aids to identify the group, if not the exact genus, of a bacterium - providing, of course, that one has an effective key. Such a key is **Bergey's Manual of Determinative Bacteriology**, the "field guide" to identification of the bacteria. Bergey's Manual describes affiliated groups of **Bacteria** and **Archaea** based on a few easily observed microscopic and physiologic characteristics. Further identification requires biochemical tests which will distinguish genera among families and species among genera. Strains within a single species are usually distinguished by genetic or immunological criteria.

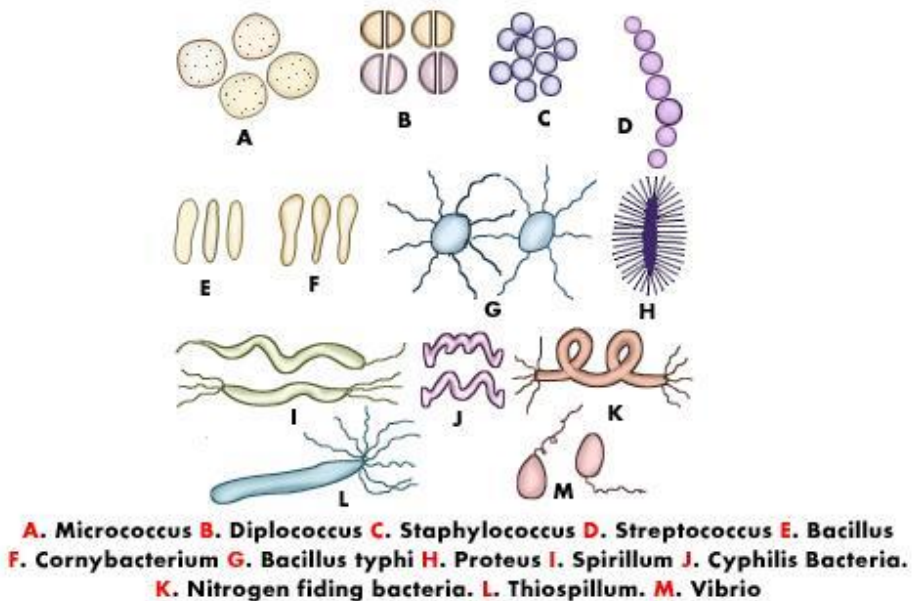

Figure 4. Different shapes and arrangements of bacterial cells, with examples.

Bacteria have a wide range of environmental and nutritive requirements.

Most bacteria may be placed into one of three groups based on their response to gaseous oxygen. **Aerobic** bacteria thrive in the presence of oxygen and require it for their continued growth and existence. Other bacteria are **anaerobic**, and cannot tolerate gaseous oxygen, such as those bacteria which live in deep underwater sediments, or those which cause bacterial food poisoning. The third group is the **facultative anaerobes**, which prefer growing in the presence of oxygen, but can continue to grow without it.

Bacteria may also be classified both by the mode by which they obtain their energy. Classified by the source of their energy, bacteria fall into two categories: heterotrophs and autotrophs. **Heterotrophs** derive energy from breaking down complex organic compounds that they must take in from the environment -- this includes saprobic bacteria found in decaying material, as well as those that rely on **fermentation** or **respiration**.

The other group, the **autotrophs**, fix carbon dioxide to make their own food source; this may be fueled by light energy (**photoautotrophic**), or by oxidation of nitrogen, sulfur, or other elements (**chemoautotrophic**). While chemoautotrophs are uncommon, photoautotrophs are common and quite diverse. They include the cyanobacteria, green sulfur bacteria, purple sulfur bacteria, and purple nonsulfur bacteria. The sulfur bacteria are particularly interesting, since they use hydrogen sulfide as hydrogen donor, instead of water like most other photosynthetic organisms, including cyanobacteria.

Bacteria exhibit different modes of nutrition. On this basis, broadly two types of bacteria can be recognised **autotrophic bacteria** and **heterotrophic bacteria**.

Autotrophic Bacteria

These are bacteria which are able to synthesize their own organic food from inorganic substances. They use carbon dioxide for obtaining carbon and utilise hydrogen sulphide (H₂S) or ammonia (NH₃) or hydrogen (H₂) as the source of hydrogen to reduce carbon. These bacteria can be distinguished further into two types as follows:

Photoautotrophic Bacteria

The **photoautotrophic bacteria** possess photosynthetic pigments in membrane bound lamellae (or thylakoids) and utilise solar energy. The bacterial photosynthesis is different from that of green plants since here water is not used as a hydrogen donor. Hence oxygen is not released as a byproduct. For this reason, the process is described as anoxygenic photosynthesis.

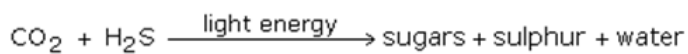

Chemosynthetic Bacteria

These are bacteria which manufacture organic compounds from inorganic raw materials utilising energy liberated from the oxidation of inorganic substances. Following are the common types of chemo autotrophic bacteria.

1. Nitrifying bacteria which derive energy by oxidizing ammonia into nitrates. Eg: *Nitrosomonas*, *Nitrobacter*.

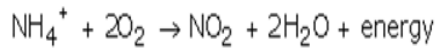

2. Sulphur bacteria which derive energy by oxidising hydrogen sulphide to sulphur. Eg: *Thiobacillus*, *Beggiatoa*.

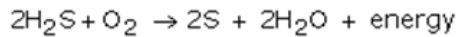

3. Iron Bacteria which derive energy by oxidising ferrous ions into ferric form. Eg: *Ferrobacillus*, *Gallionella*.



Figure 5. Photomicrographs (phase contrast and ordinary illumination) of various photosynthetic bacteria. Magnifications are about 1400X. The purple and green bacteria exhibit a full range of procaryotic morphologies, as these photomicrographs illustrate. Diversity among their phylogenetic relationships is also noted.



A. Purple sulfur bacteria (L to R): *Chromatium vinosum*, *Thiospirillum jenense*, *Thiopedia rosea*.

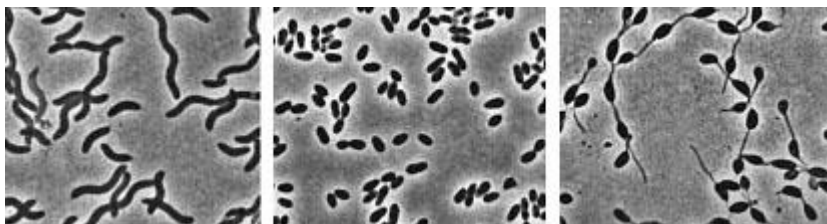

B. Purple nonsulfur bacteria (L to R): *Rhodospirillum rubrum*, *Rhodobacter sphaeroides*, *Rhodomicrobium vannielii*. The purple

nonsulfur bacteria are in the Alphaproteobacteria, which also includes *Rhizobium*, *Agrobacterium* and the Rickettsias. The latter bacteria represent a direct lineage to mitochondria.

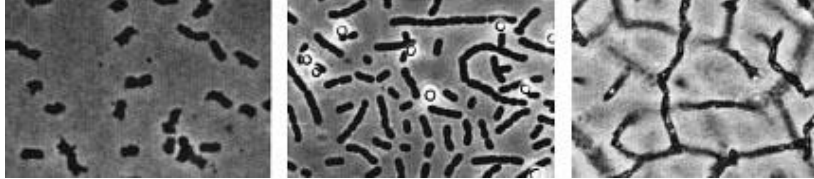

C. Green sulfur bacteria (L to R): *Chlorobium limicola*, *Prosthecochloris aestuarii*, *Pelodictyon clathratiforme*. The Green sulfur bacteria represent a distinct phylogenetic lineage and cluster in their own phylum represented by *Chlorobium*.

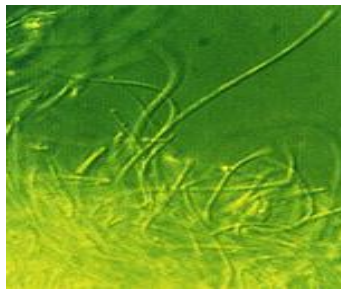

D. Green nonsulfur bacterium, *Chloroflexus*. *Chloroflexus* also represents a phylogenetically distinct group of green bacteria. *Chloroflexus* is a thermophilic, filamentous gliding bacterium.

Heterotrophic Bacteria

These are bacteria which are unable to manufacture their own organic food and hence are dependent on external source. These bacteria can be distinguished into three groups as follows:

Saprophytic Bacteria:

These bacteria obtain their nutritional requirements from dead organic matter. They breakdown the complex organic matter into simple soluble form by secreting exogenous enzymes. Subsequently they absorb the simple nutrients and assimilate them, during which they release energy. These bacteria have a significant role in the ecosystem, functioning as decomposers.

The aerobic breakdown of organic matter is called as decay or decomposition. It is usually complete and not accompanied by the release of foul gases. Anaerobic breakdown of organic matter is called fermentation. It is usually incomplete and is always accompanied by the release of foul gases. Anaerobic breakdown of proteins is called putrefaction.

The property of decomposition of organic compounds is employed in several industrial processes such as ripening of cheese, in the retting of fibres and in the curing of tobacco.

Symbiotic Bacteria

These are bacteria which live in a mutually beneficial association with other organisms. Such bacteria derive the essential nutrients from their host organisms and in that process help the host through some of their biological activities.

1. The most familiar example of symbiotic bacteria are the nitrogen fixing bacteria found in the root nodules of leguminous plants. Bacteria such as *Rhizobium* and *Pseudomonas* reside in the root nodules and reduce atmospheric nitrogen directly to ammonia. This becomes the source of nitrogen for the host plants. The plants in return provide bacteria with nutrients and protection.
2. The bacteria found in the human alimentary canal *Escherichia coli* are nonpathogenic. These bacteria check the growth of harmful putrefying bacteria. In addition, these bacteria release vitamins K and B₁₂ which are necessary for blood components. The human host provides shelter and food for these bacteria.
3. A similar example is that of cellulose digesting bacteria which occur in the alimentary canal of ruminant mammals such as cows and goats.



Figure 7. Root hair legumes.

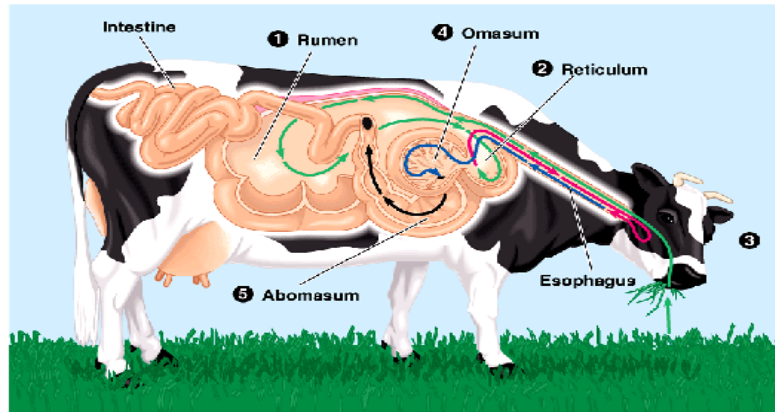

Figure 8. Mutualistic interaction inside cow rumen. (The cow as an example of a ruminant animal)

In contrast to humans ruminant animals have complex stomachs that harbor large numbers of microorganisms. These microbes degrade the plant stuff eaten by the animal into usable nutrients. Without the assistance of the microbes, ruminant animals would not be able to digest the food they eat.

Parasitic Bacteria

These are bacteria which occur in the body of animals and plants, obtaining their organic food from there. Most of these bacteria are **pathogenic**, causing serious diseases in the host organisms either by exploiting them or by releasing poisonous secretions called toxins.

Bacteria play important roles in the global ecosystem.

The ecosystem, both on land and in the water, depends heavily upon the activity of bacteria. The cycling of nutrients

such as carbon, nitrogen, and sulfur is completed by their ceaseless labor.

Organic carbon, in the form of dead and rotting organisms, would quickly deplete the carbon dioxide in the atmosphere if not for the activity of decomposers. This may not sound too bad to you, but realize that without carbon dioxide, there would be no photosynthesis in plants, and no food. When organisms die, the carbon contained in their tissues becomes unavailable for most other living things. **Decomposition** is the breakdown of these organisms, and the release of nutrients back into the environment, and is one of the most important roles of the bacteria.

The cycling of **nitrogen** is another important activity of bacteria. Plants rely on nitrogen from the soil for their health and growth, and cannot acquire it from the gaseous nitrogen in the atmosphere. The primary way in which nitrogen becomes available to them is through **nitrogen fixation** by bacteria such as *Rhizobium*, and by cyanobacteria such as *Anabaena*, *Nostoc*, and *Spirulina*, shown at right. These bacteria convert gaseous nitrogen into nitrates or nitrites as part of their metabolism, and the resulting products are released into the environment. Some plants, such as liverworts, cycads, and legumes have taken special advantage

of this process by modifying their structure to house the bacteria in their own tissues. Other **denitrifying** bacteria metabolize in the reverse direction, turning nitrates into nitrogen gas or nitrous oxide. When colonies of these bacteria occur on croplands, they may deplete the soil nutrients, and make it difficult for crops to grow.

Bacterial Reproduction:

Growth is an orderly increase in the quantity of cellular constituents. It depends upon the ability of the cell to form new protoplasm from nutrients available in the environment. In most bacteria, growth involves increase in cell mass and number of ribosomes, duplication of the bacterial chromosome, synthesis of new cell wall and plasma membrane, partitioning of the two chromosomes, septum formation, and cell division. This asexual process of reproduction is called **binary fission**.

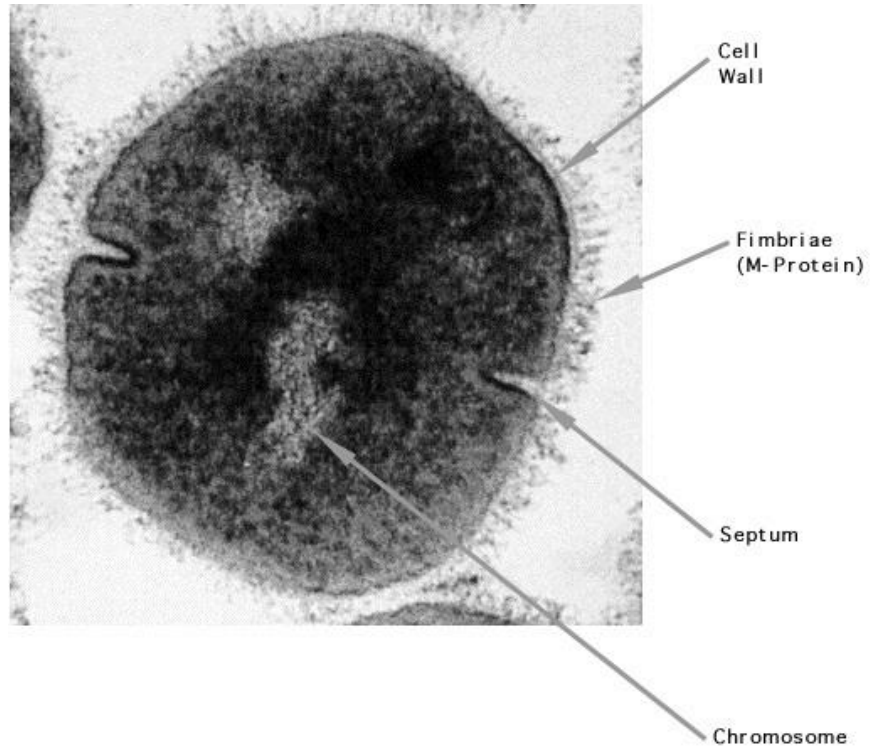

Figure 9. Bacterial growth by binary fission.

Most bacteria reproduce by a relatively simple asexual process called binary fission: each cell increases in size and divides into two cells. During this process there is an orderly increase in cellular structures and components, replication and segregation of the bacterial DNA, and formation of a septum or cross wall which divides the cell into two progeny cells. The process is coordinated by the bacterial membrane perhaps by means of mesosomes. The DNA molecule is believed to be attached to a point on the membrane where it is replicated. The two DNA molecules remain attached at

points side-by-side on the membrane while new membrane material is synthesized between the two points. This draws the DNA molecules in opposite directions while new cell wall and membrane are laid down as a septum between the two chromosomal compartments. When septum formation is complete the cell splits into two progeny cells. The time interval required for a bacterial cell to divide or for a population of bacterial cells to double is called the generation time. Generation times for bacterial species growing in nature may be as short as 15 minutes or as long as several days. Electron micrograph of *Streptococcus pyogenes*.

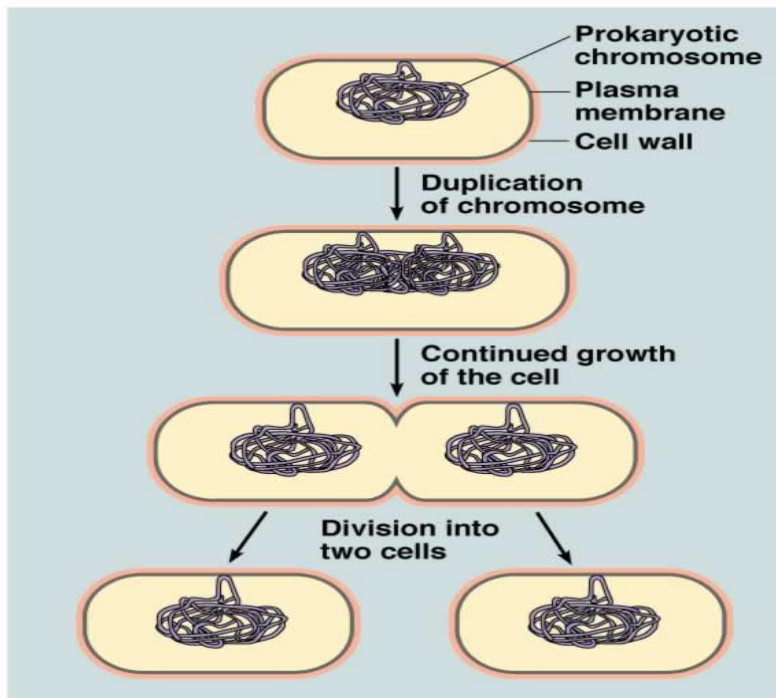

Figure 10. Bacterial growth by binary fission.

Bacterial Recombination:

Binary fission is an effective way for bacteria to reproduce, however it does produce problems. Since the cells produced through this type of reproduction are identical, they are all susceptible to the same types of antibiotics. In order to incorporate some genetic variation, bacteria use a process called recombination. Bacterial recombination can be accomplished through conjugation, transformation, or transduction.

Conjugation

Some bacteria are capable of transferring pieces of their genes to other bacteria that they come in contact with. During conjugation, one bacterium connects itself to another through a protein tube structure called F or sex pilus which is also the conduit for the transfer of the genetic material. Genes are transferred from one bacterium to the other through this tube and it requires physical contact between the two bacteria involved.

Basic conjugation involves two strains of bacteria: F⁺ and F⁻. The difference between these two strains is the presence of a Fertility factor (or F factor) in the F⁺ cells. The F factor is an episome that contains 19 genes and confers the ability to

conjugate upon its host cell. Genetic transfer in conjugation is from an F⁺ cell to an F⁻ cell, and the genetic material transferred is the F factor itself. Here is an overview of the process:

Transformation

Some bacteria are capable of taking up DNA from their environment. These DNA remnants most commonly come from dead bacterial cells. During transformation, the bacterium binds the DNA and transports it across the bacterial cell membrane. The new DNA is then incorporated into the bacterial cell's DNA.

Transduction

Transduction is a type of recombination that involves the exchanging of bacterial DNA through bacteriophages. Bacteriophages are viruses that infect bacteria. There are two types of transduction: generalized and specialized transduction.

Once a bacteriophage attaches to a bacterium, it inserts its genome into the bacterium. The viral genome, enzymes, and viral components are then replicated and assembled within the host bacterium. The newly formed bacteriophages then lyse or split open the bacterium, releasing the replicated viruses.

During the assembling process however, some of the host's bacterial DNA may become encased in the viral capsid instead of the viral genome. When this bacteriophage infects another bacterium, it injects the DNA fragment from the previous bacterium. This DNA fragment then becomes inserted into the DNA of the new bacterium. This type of transduction is called generalized transduction.

In specialized transduction, fragments of the host bacterium's DNA become incorporated into the viral genomes of the new bacteriophages. The DNA fragments can then be transferred to any new bacteria that these bacteriophages infect.

<p>Basic conjugation occurs between an F⁺ cell and an F⁻ cell. The difference between these two types of cells is the presence or absence of the F (fertility) factor, which is a circular DNA molecule independent of the bacterial chromosome (the larger circular molecule).</p>	
<p>The F⁺ cell initiates conjugation by extending an F pilus toward the F⁻ cell. Among the genes present on the F factor are the genes encoding the proteins required for pilus construction.</p>	
<p>The F pilus, when finished, temporarily connects the two cells. On strand of the F factor is nicked, and begins unwinding from the other strand. The nicked strand begins to transfer through the F pilus to the F⁻ cell. As it does so, this strand begins to be replicated, as does circular strand remaining behind in the F⁺ cell.</p>	
<p>Eventually, the nicked strand completely passes through to the recipient cell, and is completely replicated. This process produces a new F factor in the recipient cell. The pilus is broken, severing the connection between the two cells. Since both cells now contain an F factor, both cells are F⁺. The new F⁺ cell (which was the F⁻ cell), can now initiate conjugation with another F⁻ cell.</p>	

Recombination rarely occurs with this kind of conjugation. This is because the F factor is not homologous to the DNA in the bacterial chromosome. As we will see, however, there are variations of this basic conjugation process that allow recombination to occur.

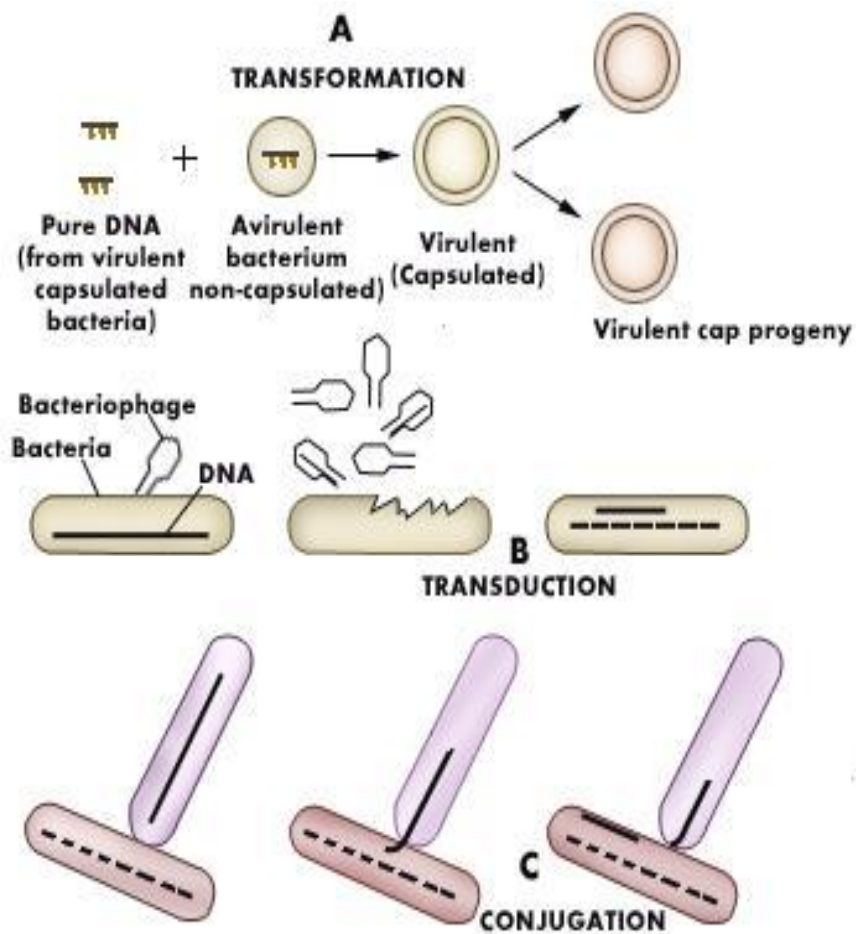

Figure 11. Genetic recombination of bacteria

Is bacterial Endospores a kind of reproduction?

A bacterial structure sometimes observed as an inclusion is actually a type of dormant cell called an **endospore**. Endospores are formed by a few groups of **Bacteria** as intracellular structures, but ultimately they are released as free endospores. Biologically, endospores are a fascinating type of cell. Endospores exhibit no signs of life, being described as **cryptobiotic**. They are highly resistant to environmental stresses such as high temperature (some endospores can be boiled for hours and retain their viability), irradiation, strong acids, disinfectants, etc. They are probably the most durable cell produced in nature. Although cryptobiotic, they retain viability indefinitely such that under appropriate environmental conditions, they germinate back into vegetative cells. Endospores are formed by vegetative cells in response to environmental signals that indicate a limiting factor for vegetative growth, such as exhaustion of an essential nutrient. They germinate and become vegetative cells when the environmental stress is relieved. Hence, endospore-formation is a mechanism of survival rather than a mechanism of reproduction.

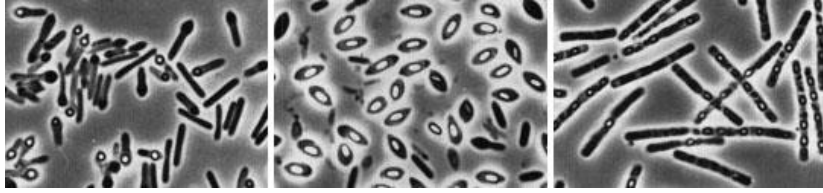
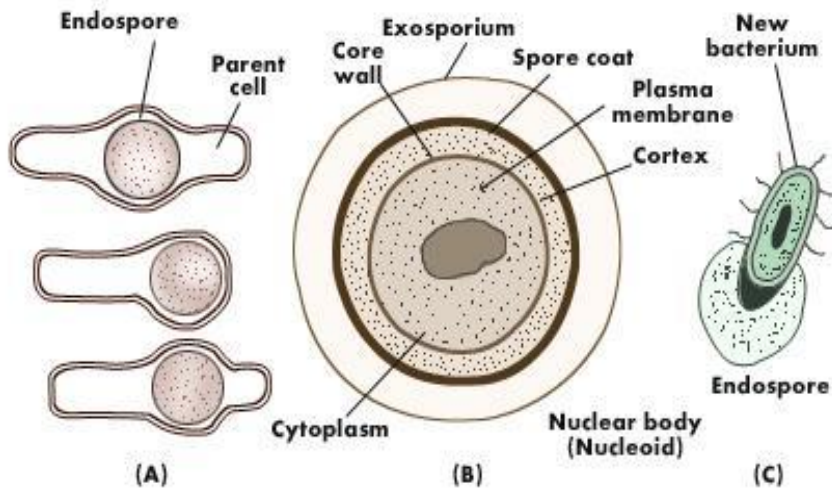

Figure 12. Bacterial endospores. Phase microscopy of sporulating bacteria demonstrates the refractility of endospores, as well as characteristic spore shapes and locations within the mother cell.



Endospore formation. A, Endospores according to their position in parent cells. B, An endospore in cross-section. C, Germination of endospore

LECTURE (3)

CYANOPHYTA

Introduction and uniqueness

The group cyanobacteria include another successful group of prokaryotes namely blue green algae. They are photoautotrophic prokaryotes occupying a wide range of

habitats. They are predominantly aquatic, found mostly in fresh water bodies. Some species occur in marine water. A few are terrestrial, found in moist soil and on moist rocks.

The algae are the simplest members of the plant kingdom, and the blue-green algae are the simplest of the algae. They have a considerable and increasing economic importance; they have both beneficial and harmful effects on human life. Blue-greens are not true algae. They exist as unicells, colonies or filaments. They have a bacterial type cell wall, no nucleus and no flagella. In addition to bacterial chlorophyll, they have the pigments phycocyanin and phycoerythrin. Blue-greens are responsible for **nitrogen fixation** on land and in water. Like green algae, they can form lichen symbioses with fungi.

In fact blue-greens are more closely to bacteria which have similar biochemical and structural characteristics. The process of nitrogen fixation and the occurrence of gas vesicles are especially important to blue-greens. The blue-greens are widely distributed over land and water, often in environments where no other vegetation can exist. Their fossils have been identified as over three billion years old. They were probably the chief primary producers of organic matter and the first organisms to release elemental oxygen, O₂, into the primitive atmosphere, which was until then free

from O₂. Thus blue-greens were most probably responsible for a major evolutionary transformation leading to the development of aerobic metabolism and to the subsequent rise of higher plant and animal forms. They are referred to in literature by various names, which are Cyanophyta, Myxophyta, Cyanobacteria, blue-green algae, blue-green bacteria.

The majority of blue-greens are aerobic photoautotrophs: their life processes require only oxygen, light and inorganic substances.

At the onset of nitrogen limitation during bloom conditions, certain cells in *Anabaena* and *Nostoc* evolve into heterocysts, which convert nitrogen gas into ammonium, which is then distributed to the neighboring cells of a filament. In addition, blue-greens that form symbiotic (mutually beneficial) relationships with a wide range of other life forms, can convert nitrogen gas into ammonium.

Finally, at the onset of adverse environmental conditions, some blue-greens can develop a modified cell, called an akinete. Akinetes contain large reserves of carbohydrates, and owing to their density and lack of gas vesicles, eventually settle to the lake bottom. They can tolerate adverse conditions such as the complete drying of a pond or the cold winter temperatures, and, as a consequence, akinetes

serve as "seeds" for the growth of juvenile filaments when favorable conditions return. Heterocysts and akinetes are unique to the blue-greens.

Gliding movement

When viewed under the light microscope, blue-greens show a variety of movements, such as gliding, rotation, oscillation, jerking and flicking.

Benefits

Heterocystous blue-greens possess the unique ability to simultaneously evolve O_2 in photosynthesis (in vegetative cells) and H_2 by nitrogenase catalyzed electron transfer to H^+ -ions (in heterocysts), in the absence of N_2 or other substrates of nitrogenase. This is the basis for the attempts of several workers to exploit the potential through the development of a 'biophotolytic system' for solar energy conversion, even though to date the thermodynamic efficiency has been disappointingly low.

Nevertheless, the utilization of blue-greens in food production and in solar energy conversion may hold immense potential for the future, and could be exploited for man's economy. Progress in the study of the genetics of blue-greens

may enable us to manipulate the N₂-fixation (*nif*) and associated genes, and produce strains which fix N₂, evolve H₂ or release ammonia with great efficiency.

Colour and identification

The blue-green color of cells (cyan means blue-green) is due to the combination of green chlorophyll pigment and a unique blue pigment (phycocyanin). The blue-greens are microscopic life forms that exhibit several different types of organization. Some grow as single cells enclosed in a sheath of slime-like material, or mucilage. The cells of others aggregate into colonies that are either flattened, cubed, rounded, or elongated into filaments. Actual identification of cyanobacteria (blue-greens) requires microscopic examination of cells, colonies, or filaments, although experienced aquatic biologists can usually recognize *Microcystis* (colonies look like tiny grey-green clumps) and *Aphanizomenon* (green, fingernail-like or grass-like clippings).

The Thallus

The plant body or thallus of blue green algae ranges from unicellular to multicellular, branched forms. There are no

flagella but some members exhibit a movement caused by gliding.

Cell Structure

Each cell whether in a unicellular form like *Gleocapsa* or multicellular form like *Nostoc*, has a definite cell wall. Most often it is surrounded by a thin or thick mucilagenous sheath. The inner layer of cell wall has a chemical composition similar to bacterial cell, made up of peptidoglycans. The cell wall is followed by a cell membrane composed of lipids and proteins. The inner contents of the cell can be distinguished into an outer pigmented region called **chromoplasm** and a central clear, hyaline region called **centroplasm**. The centroplasm contains photosynthetic pigments chlorophyll - a, b, carotene and others located in broad sheet-like, structures called **thylakoids**. The central nucleoid has many irregularly arranged fine strands of DNA.

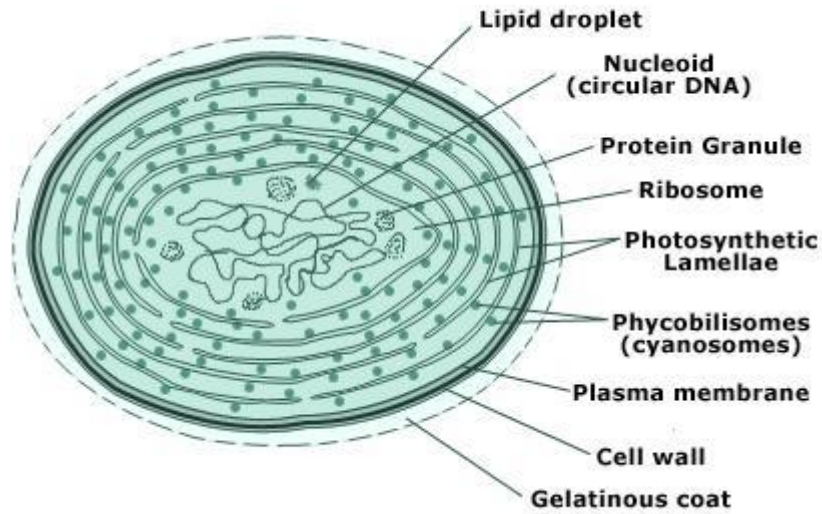

Figure 1. Cell Structure of Cyanobacteria

The planktonic forms contain gas vacuoles in their cells to help in floating.

Some cyanophycean members possess special types of cells called heterocysts, as in *Anabena* and *Nostoc*. They are large, thick walled, round cells without a nucleoid. These cells represent the sites of protein synthesis. They also represent regions where filaments can break into fragments.

Pigments

Blue green algae contain in addition to chlorophyll, other photosynthetic pigments, such as Phycobillins. Phycobillins are of three types phycocyanin (blue), allophycocyanin (blue) and phycoerythrin (red).

Reproduction

Cyanobacteria reproduce mostly by vegetative and asexual methods. Vegetative reproduction occurs by fission or fragmentation or by the formation of hormogonia. Unicellular forms exhibit fission while filamentous multicellular forms exhibit fragmentation.

Asexual reproduction occurs by the formation of thick walled cells called **akinites**, which can also store reserve food material. In some members endogenous or exogenous spores may be formed. There is no sexual reproduction, but genetic recombination as in bacteria has been reported in some species like *Cylindrospermum majus* and *Anacystic ridulans*. Conjugation has not been observed in cyanobacteria, but gene recombination is known to occur in some forms.

Oscillatoria



Figure 2. *Oscillatoria*

This genus is named for the gliding, rotating, or oscillating motion of the filament around its axis. The trichomes are straight, slightly undulating, or coiled, and are made up of disk-shaped cells wider than they are long. In some species the end cells can be rounded or tapered. The cells do not have gas vesicles, but sometimes contain large granules.

During reproduction, the filaments break apart at separation disks to release short hormogonia. The cells divide in a rapid sequence transversely to the trichome axis.

Unlike Lyngbya and Phormidium, *Oscillatoria* does not usually have a true sheath, although parallel filaments may form a thin film. Mucilage sheaths may also occasionally form under stressful conditions, such as desiccation or hypersalinity, or in culture.

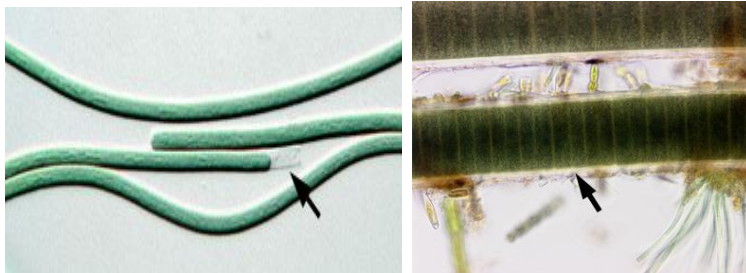

Figure 3. *Oscillatoria* culture specimens did possess sheaths (arrow).

Lyngbya



Figure 4. *Lyngbya*

Lyngbya has unbranched filaments that are straight, slightly wavy, or rarely coiled, and usually form large, layered, leathery mats of varied thickness. The filaments are cylindrical and usually wider than 6 μm . The cells are shorter than they are wide and may have a restricted cell wall. The apical cells often have a thickened cell wall called a calyptra. A rigid, distinct mucilage sheath is always present. The mucous can be thin or thick, and is colorless or slightly red, yellow-brown, or occasionally blue. Very rarely, false branching may form. Under extreme conditions the trichomes may leave the sheaths. *Lyngbya* is very similar to *Phormidium*, which has a looser sheath, and to *Oscillatoria*, which normally lacks a sheath. These three genera can be very difficult to distinguish.

Anabena

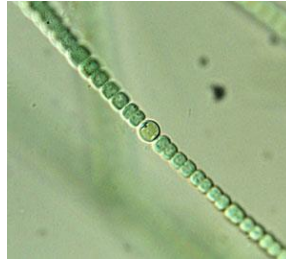

Figure 5. *Anabena*

Anabena is a genus of filamentous cyanobacteria, or blue-green algae, found as plankton. It is known for its nitrogen fixing abilities, and they form symbiotic relationships with certain plants, such as the mosquito fern.

Nostoc

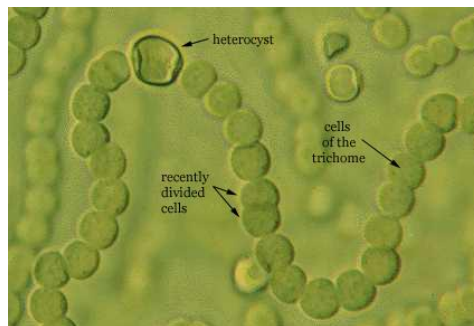

Figure 6. *Nostoc*

Nostoc is common in both terrestrial and sub aerial habitats. It is widely distributed in alkaline soils and on damp rocks and cliffs. The *Nostoc* forms a jelly like mass in which numerous filaments (trichomes) are embedded. The cells are

joined to form trichomes, which are unbranched and appear moniliform. Individual cells are mostly spherical but sometimes barrel shaped or cylindrical.

All cells in trichome are mostly similar in structure but at interval are found slightly large, round, light yellowish thick walled cells known as heterocysts. Trichome mostly breaks near heterocyst and forms hormogonia. So heterocysts help in fragmentation.

Reproduction

Sexual reproduction is absent. It reproduces by formation of hormogonia. Hormogonia are formed when filament breaks at different points into smaller pieces. This is due to death and decay of an ordinary cell or the heterocyst may serve as a breaking point. Reproduction can also be due to akinetes formation. Akinetes are thick walled, enlarged vegetative cells, which accumulate food and become resting cells. On the onset of favorable conditions they form normal vegetative cells.

Spirulina

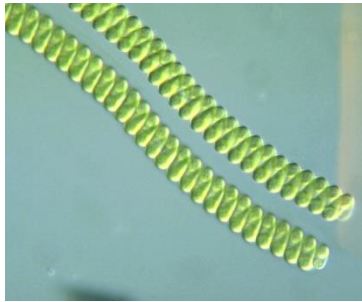

Figure 7. *Spirulina*

It is a simple, one-celled form of algae that thrives in warm, alkaline fresh-water bodies. The name "*spirulina*" is derived from the Latin word for "helix" or "spiral"; denoting the physical configuration of the organism when it forms swirling, microscopic strands.

ALGAE

The algae are an ancient group of aquatic plants. Some taxonomists consider the algae to be Protoctists but this approach will not be followed here. There are thought to be about 23,000 species of algae.

There are 3 features which distinguish the algae from other plants;-

Body plan: There is no specialisation of the algal body into root, stem, leaves with vascular tissue. The photosynthetic portion of the alga is a thallus while the attachment portion comprises hair-like rhizoids. For this reason, old

classification systems put the algae into a grouping known as the Thallophytes.

No Embryo: For most algae, sperm and eggs fuse in the open water and the zygote develops into a new plant without any protection. For other plant groups the zygote develops into an embryo within the protection of the parent plant. For this reason, old classification systems termed all other plant groups Embryophytes.

Reproductive structures: The gametes are produced within a single cell. There is no jacket of sterile cells protecting the gametes.

Being aquatic, algae are

- marine
- freshwater

Terrestrial

Terrestrial algae are effectively surviving in an aquatic environment on land. Soil algae survive in a film of soil water.

The other major group of terrestrial algae are those in **lichen** symbioses.

As terrestrial plants the algae have a unique role as pioneer plants. They grow on bare rock, providing there is moisture. The rock weathers and crumbles. The algae die. The mineral contribution of the rock and the organic remains of the algae

lead to formation of soil. This pioneering activity therefore paves the way for more demanding plants to invade. A succession such as this is precisely what would have occurred when the islands of the Caribbean first emerged from the sea.

Within the aquatic environment, there are two broad niches;-

planktonic - floating algae.

For micro-algae these often have strange shapes which help keep the algae suspended as well as serve an anti-predation role.

benthic - attached algae.

These are algae anchored to the substratum

ECONOMIC SIGNIFICANCE

Algae are primary producers, i.e. they are the start of the food chain. One third of all the carbon fixed on this planet is achieved by algae, largely in the oceans!

Algae under particular nutrient-rich conditions may grow disproportionately causing potentially harmful **algal blooms**.

Seaweeds are used as fertilisers and even **food** (by the Japanese, Irish, Welsh and even some of the Caribbean who enjoy "sea moss").

Extracts from the cell walls of (typically brown & red) algae provide the polysaccharides agar and carageenan. These are

used as thickening agents in food, in surgical dressings and in microbial media.

Diatomaceous earth. The skeletons of a group of algae, the diatoms, are glass-like and this material is put to a variety of uses, such as abrasives (it used to be used in toothpaste!), reflective road signs, swimming pool filters.

ALGAL CLASSIFICATION

Algae are largely classified on the basis of:-

- **colour (photosynthetic pigments)**
- **storage material**
- **flagella**
- **cell wall**

The algae are a very heterogeneous grouping. Traditional taxonomists have considered each group (greens, reds etc) a division which means that while all algae share the feature of being simple plants, "reds" are as distinct from "browns" as ferns are compared to flowering plants! One fundamental difference between algal groups is the structure of the chloroplast. Green and red algae have simple plastids with 2 outermost membranes while the other algal groups have complex plastids with 3 or more bounding membranes.

The major groups of eukaryotic algae are the green algae, diatoms, red algae, brown algae, and dinoflagellates. They are classified as protista. Another group, the blue-green

algae, is the cyanobacteria. Some authorities do not consider the blue-green algae to be true algae because they are **prokaryotes**, not eukaryotes.

Table 1. Photosynthetic pigments of monerans, algae, and plants

Taxonomic Group	Photosynthetic Pigments
Cyanobacteria	chlorophyll <i>a</i> , chlorophyll <i>c</i> , phycocyanin, phycoerythrin
Chloroxybacteria	chlorophyll <i>a</i> , chlorophyll <i>b</i>
Green Algae (Chlorophyta)	chlorophyll <i>a</i> , chlorophyll <i>b</i> , carotenoids
Red Algae (Rhodophyta)	chlorophyll <i>a</i> , phycocyanin, phycoerythrin, phycobilins
Brown Algae (Phaeophyta)	chlorophyll <i>a</i> , chlorophyll <i>c</i> , fucoxanthin and other carotenoids
Golden-brown Algae (Chrysophyta)	chlorophyll <i>a</i> , chlorophyll <i>c</i> , fucoxanthin and other carotenoids
Dinoflagellates (Pyrrhophyta)	chlorophyll <i>a</i> , chlorophyll <i>c</i> , peridinin and other carotenoids
Vascular Plants	chlorophyll <i>a</i> , chlorophyll <i>b</i> , carotenoids

LECTURE (4)

DIVISION: CHLOROPHYTA

Green Algae. Green algae are the algae most closely related to plants. They have the same pigments (chlorophyll a and b and carotenoids), the same chemicals in their cell walls (cellulose), and the same storage product (starch) as plants. Green algae may be unicellular or form filaments, nets, sheets, spheres, or complex moss-like structures. There are both freshwater and marine species. Some species of green algae live on snow, or in symbiotic associations as lichens, or with sponges or other aquatic animals. Edible green algae include *Chlorella* and sea lettuce. There are at least seventeen thousand species of green algae.

These are closest to the higher plants in many ways and are considered their ancestors as they share common features:-

- photosynthetic pigments - chlorophylls a & b, β -carotene
- cell wall - cellulose-rich
- reserves - starch

This is a very diverse group, showing almost the full spectrum of morphological possibilities - from unicells to macroalgae.

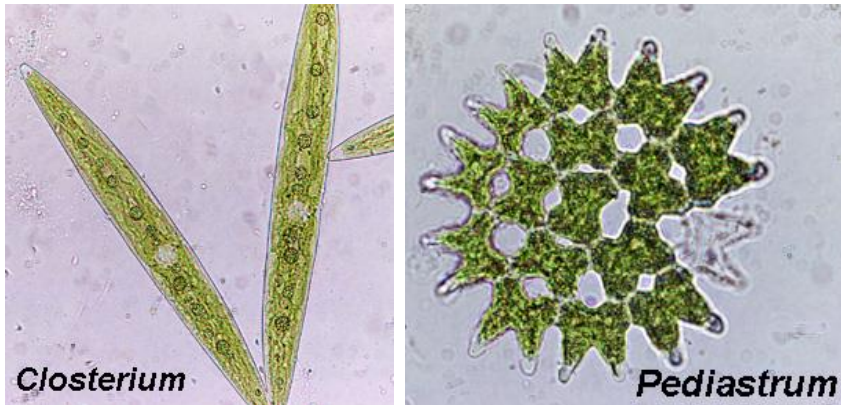

Figure 1. *Closterium* and *Pediastrum*

Ultrastructure

They are Eukaryotes and have the "Usual Suspects" when it comes to organelles. Some species form Cell Plates during Mitosis, that are similar to those found in land plants. Some species have Flagella. However, flagellated cells are usually Gametes or Spores Chloroplasts have the typical Double Boundary Membrane. This is similar to land plants.

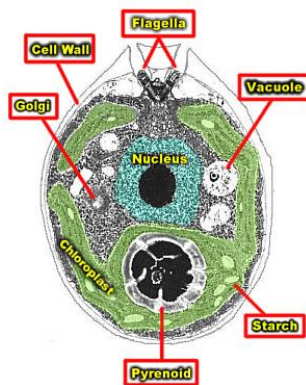

Figure 2. Structure of green algal cell

Chloroplast Shape varies. The trend is towards an increase in Surface Area. Common Chloroplasts Shapes include Cup, Filament, Star, Reticulate (Net), Banded A few have the Discoid Shape of most Terrestrial Plants

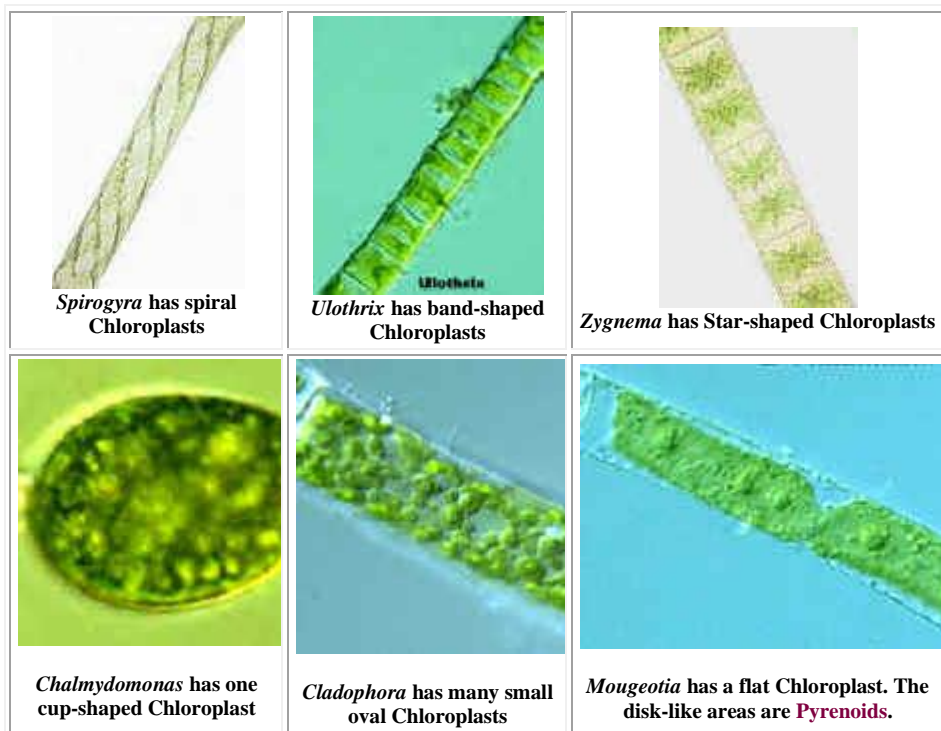
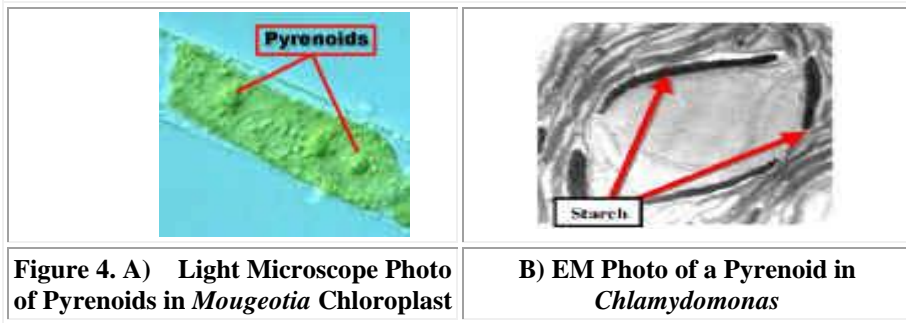

Figure 3. Different shapes of chloroplasts in green algae.

Pyrenoids occur in most species. Starch is the major storage product. Starch is stored in the Stroma of the Chloroplast. This is similar to land plants. This is unusual for Algae. It tends to make the Chloroplasts have a lumpy appearance. Note the *Chalmydomonas* above. Most Algae store Starch in the Cytoplasm.



Morphological Diversity

There is a wide range of morphological diversity. There are Unicellular, Filamentous, Siphonous, Multicellular, Colonial, Parenchymatous, Motile, Nonmotile types. Their Size Ranges from microns to meters (8m=the largest).

Chlorophyceae

This is the Largest Class. Cup-shaped Chloroplasts are Common. An Eyespot (Stigma) is frequently present. This is used to detect light. Chloroplast shapes can vary considerably, however. Individual Chloroplasts may be interconnected. Pyrenoids are present. These appear to be areas where starch is produced. Pyrenoids also contain a high concentration of RUBISCO. They are consequently thought to be adapted for Carbon fixation at low CO₂ levels. There are at least Three Distinct Groups in the Chlorophyceae

A] Volvocine = Motile

B] Trichocine = NON-Motile & Filamentous

C] Chlorococcine = NON-Motile & NON-Filamentous

Volvocine Group

All members are flagellated. *Chlamydomonas* represents a "basal" organism from which the group may have evolved. A series of Colonial forms exists. Each cell resembles *Chlamydomonas*. The cells may be embedded in a gelatinous matrix. Cells are interconnected by cytoplasmic strands. The number of cells produced by different species is constant. The ratio of reproductive to vegetative cells is also constant for a particular species. *Volvox* represents the pinnacle of this group. It has a low ratio of reproductive to vegetative cells. However, all of the cells in *Gonium*, become reproductive. The trend is towards an increase in the number of cells as well as a trend towards cell specialization with most cells specialized for Photosynthesis.



Figure 5. *Gonium, Pandorina, Chlamydomonas, Eudorina*

Chlamydomonas Reproduction-Asexual

Haploid Motile Cells- Mitosis- 4-16 Biflagellate Cells- Small Copies of Parent Cell

Chlamydomonas Reproduction-Sexual

The Vegetative Cells are Haploid. They undergo Mitosis to produce Haploid Gametes. The Gametes are of two strains (indicated by + or -) These Unite to produce a Zygote which forms a thick wall. This is called a Zygospore. The Zygospore undergoes Meiosis to produce + & - Strains of Vegetative Cells.

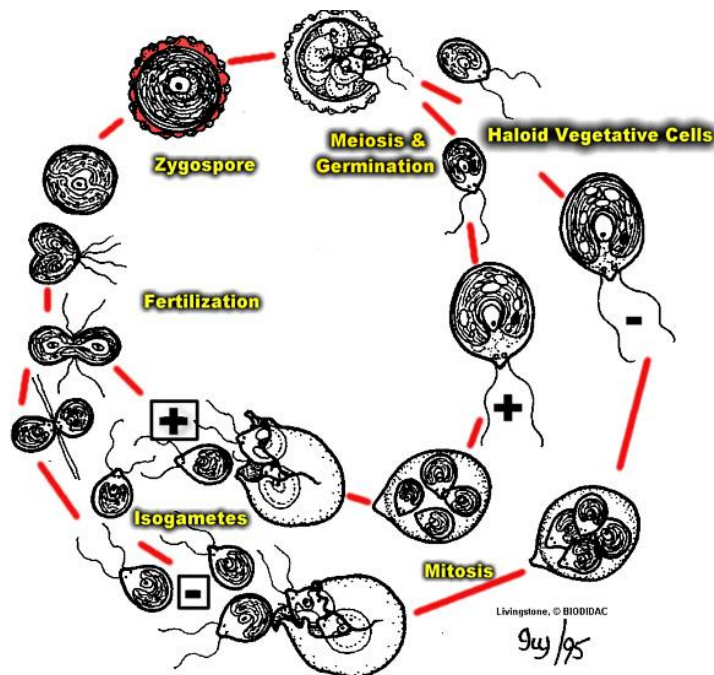

Figure 6. *Chlamydomonas* reproduction

***Volvox* Reproduction - Asexual**

The Individual cells in a *Volvox* Colony resemble *Chlamydomonas*. However, *Volvox* Colonies have two types of cells, Generative & Somatic.

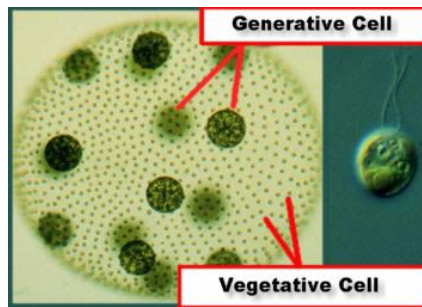
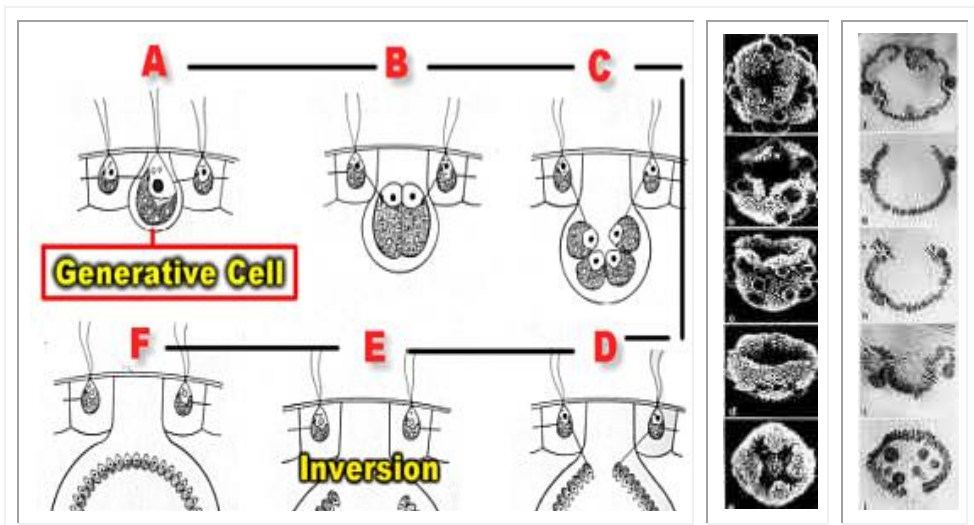

Figure 7. *Volvox*

Generative Cells subdivide by Mitosis to produce small Daughter Cells. This process continues until a small bubble-shaped, invaginated Daughter Colony develops.



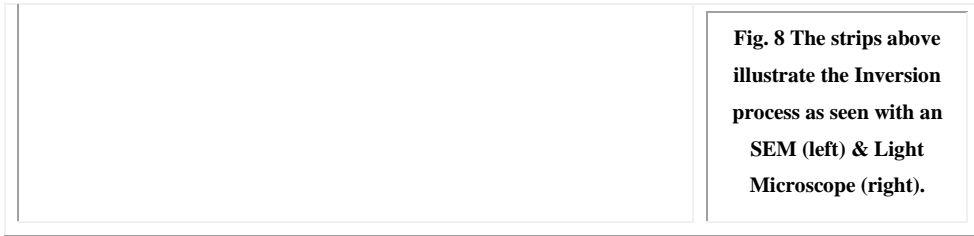

Fig. 8 The strips above illustrate the Inversion process as seen with an SEM (left) & Light Microscope (right).

These are formed inside-out so they must Invert prior to their release from the Parent Colony. The Daughter Colonies are released upon the death of the Parent Colony. The two Photographs on the right side of the Table above illustrate the Inversion process. Photos a-e were made with a Scanning Electron Microscope. Photos f-i were made with a light microscope

***Volvox* Reproduction-Sexual**

Sexual Reproduction is Oogamous. Some Generative Cells undergo repeated cell divisions to produce "Sperm Packets" These swim away as a unit in search of Eggs. Eggs develop from Generative Cells that have not undergone Mitosis. Following Fertilization, the Zygote forms a thick Spiny Cell Wall that is frequently red. This functions as a "resting" stage. Meiosis occurs inside the "resting" structure. Each Meiospore produces a new Colony.

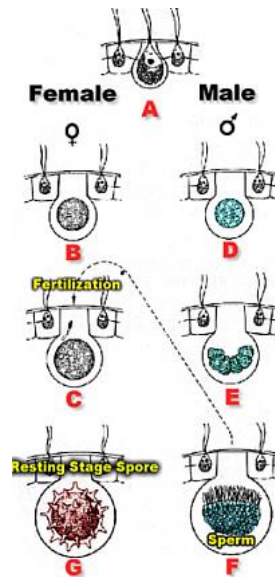

Figure 9. *Volvox* sexual reproduction



Fig. 10

Chlorococcales

These are nonmotile & nonfilamentous organisms. Reproductive cells may be motile. The latter look like *Chlamydomonas*. These range from single cells to complex

organisms but they do not reach the level of Parenchyma tissue. *Chlorella* and *Chlorococcum* are the most simple forms. Colonial forms are displayed below. These are ubiquitous in standing fresh water and are important components of freshwater ecosystems. They have important symbiotic relationships with fungi to form Lichens.

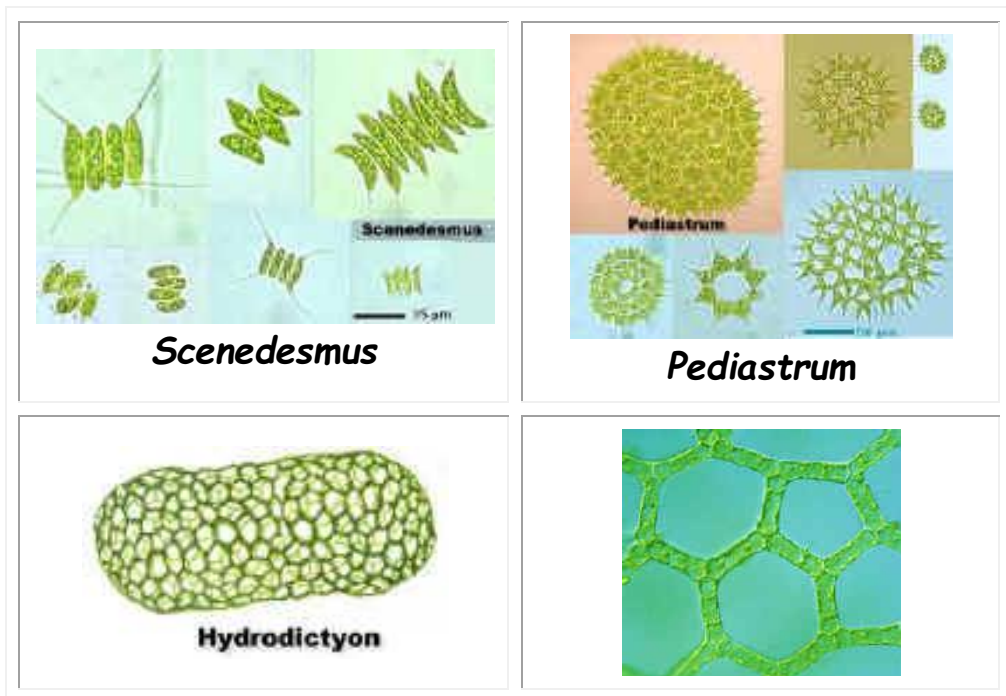

Figure 11.

Spirogyra

Spirogyra is a green alga found on the surface of ponds and slow moving rivers and streams.

Vegetative structure

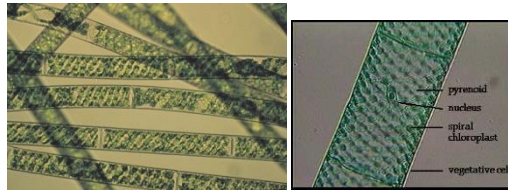

Figure 12. The filamentous alga *Spirogyra*

- It is a multicellular alga of very simple structure, consisting of an unbranched filament in which each cell is identical. There is no division of labour i.e. there is no differentiation.
- All the cells are haploid.
- The cells are cylindrical. Each cell has a cell wall surrounded by mucilage.
- Each cell has a chloroplast which is wound spirally just inside the cell wall.
- A vacuole fills the central region of the cell and the nucleus is suspended in the cell vacuole by threads of cytoplasm.

Reproduction

Asexual reproduction

This is the normal method of reproduction for *Spirogyra*. Filaments break into small lengths or single cells. By mitosis and cell enlargement each piece grows into a new filament.

Sexual reproduction

Sexual reproduction occurs when conditions are unfavourable e.g. the pond dries up. Sexual reproduction in Spirogyra is called conjugation. Each cell of the Spirogyra is a gamete (i.e. a haploid sex cell).

Conjugation in Spirogyra

1. Two filaments line up side by side.
2. Bulges appear from opposite cells.
3. The bulges touch off each other.
4. The wall between the cells break down and form a conjugation tube.
5. The protoplasts of one filament shrink faster than the other and move through the conjugation tubes. These cells are known as the male gametes (because they move). The stationary protoplasts are called the female gametes.
6. The nuclei fuse and form a diploid zygote. The stages are more or less simultaneous in all cells of a filament. Therefore after fertilization there is one filament of empty cells and one containing zygotes.
7. The zygote forms a thick wall and is then called a dormant zygospor.
8. The cell walls rupture and the dormant zygospor are liberated.
9. When favorable conditions return the zygospor germinate by meiosis. Only one of the four haploid daughter

nuclei survives and divides by mitosis to form a new filament.

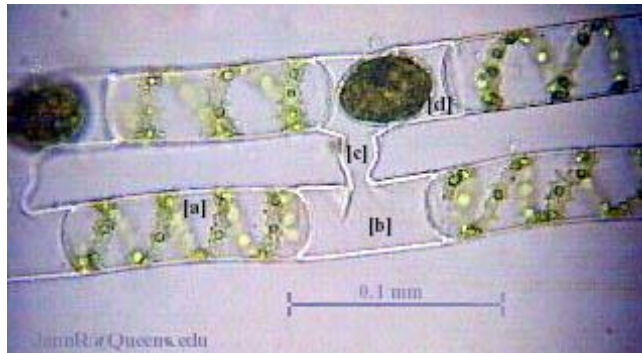

Figure 13. [c], Conjugation tubes- [a], Regular haploid cells- [d], Zygote.

DIVISION: EUGLENOPHYTA

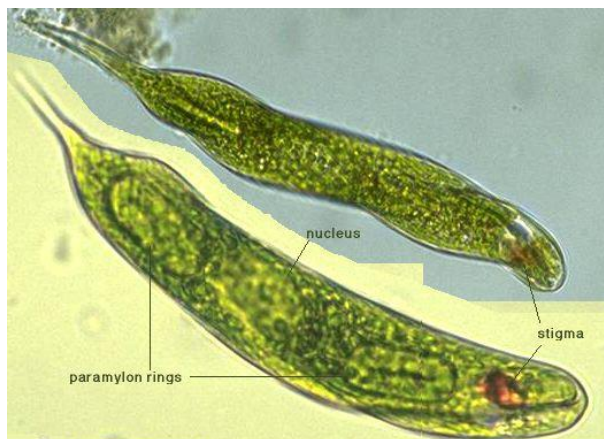

Figure 1. *Euglena*

Euglenophyta, small phylum (division) of the kingdom Protista, consisting of mostly unicellular aquatic algae. Most live in freshwater; many have flagella and are motile. The outer part of the cell consists of a firm but flexible layer

called a pellicle, or periplast, which cannot properly be considered a cell wall. Some euglenoids contain chloroplasts that contain the photosynthetic pigments chlorophyll *a* and *b*, as in the phylum Chlorophyta; others are heterotrophic and can ingest or absorb their food. Food is stored as a polysaccharide, paramylon. Reproduction occurs by longitudinal cell division. The most characteristic genus is *Euglena*, common in ponds and pools, especially when the water has been polluted by runoff from fields or lawns on which fertilizers have been used. There are approximately 1,000 species of euglenoids.

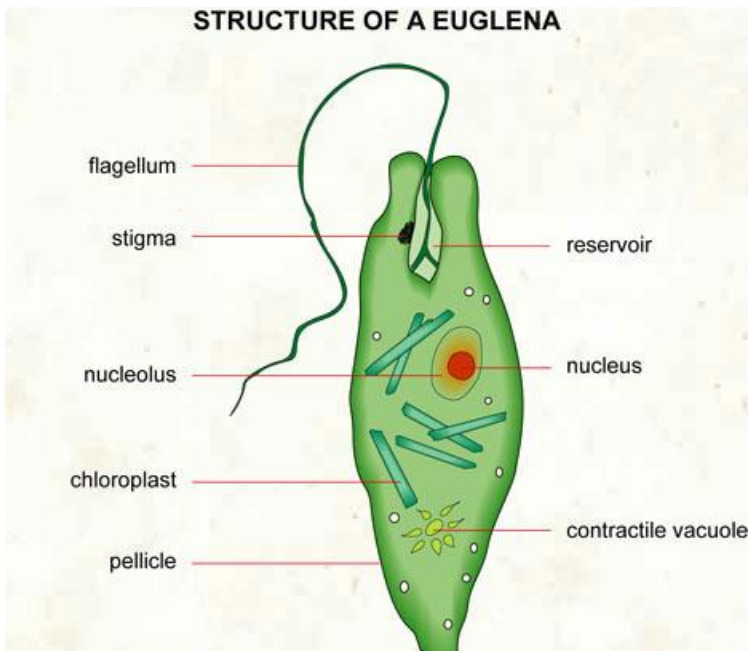

Figure 2. Structure of a *Euglena*: flagellate freshwater protozoan. It is composed of chlorophyll and has a rudimentary eye.

Reservoir: part of a euglena used for storage.

Nucleus: central organelle of a euglena.

Contractile vacuole: cavity of the euglena that is able to contract.

Pellicle: membrane that envelops a euglena.

Chloroplast: organelle of the euglena responsible for photosynthesis.

Nucleolus: spherical body that contains the nucleus of a euglena.

Stigma: light-sensitive.

Flagellum: long, mobile filament used by the euglena for locomotion.

I. Structure & metabolism

- A. Two anterior, unequal flagella, rooted within a canal, the **ampulla** or **gullet**
1. This latter term refers to the flask-like shape of the canal, with a distinct **canal** and internal **reservoir**
 2. The shorter flagellum is often very short, and may not emerge from the ampulla
 3. The longer flagellum extends forward, and is covered by two distinct kinds of fine hairs (*not* mastigonemes)
- B. Eyespot is in cytoplasm near the canal, *not* in plastid
1. Often easily visible with light microscope
 2. Composed of carotenoid globules, surrounded by individual membranes
 3. Not associated with chloroplast
 4. A swelling at the base of the longer flagellum is thought to act as a photoreceptor

- C. A contractile vacuole is present at the apical end of the cell, empties into reservoir
- D. **Pellicle** lies within the cytoplasm, at the surface of the cell
 - 1. Composed of spiral strips of protein that overlap slightly
 - 2. In many species, these can slide with respect to each other
 - 3. This produces a distinctive mobility called euglenoid movement, or **metaboly**
 - 4. Many species are rigid when swimming in plankton, but rely on metaboly when on solid surfaces
 - 5. Other species are entirely rigid, but spiral pellicle is still present
- E. Muciferous bodies secrete mucilage, which may make a thin or thick layer over the cell
 - 1. Nonmotile cells embedded in a thick layer of mucilage are considered to be palmelloid
 - 2. Some species have a **lorica**, or hard surrounding shell
- F. Nucleus with permanently condensed chromosomes
 - 1. Mitosis is closed
 - 2. Spindle is essentially entirely within nuclear envelope
 - 3. Nucleolus is persistent throughout mitosis
- G. Cytokinesis starts with replication of basal bodies and flagella
 - 1. Nucleus migrates to apical end of cell, and basal bodies associate with developing spindle poles

2. Mitosis is followed by longitudinal furrowing of cell
 3. Pellicle strips twist in two spirals, so that cell divides without disrupting spiral arrangement-- very elegant
- H. Chloroplasts (if present) is thought to be a secondary plastid derived from green algae
1. Typically multiple chloroplasts per cell
 2. Surrounded by three membranes, without a CER or nucleomorph
 3. Thylakoids in groups of three, without a girdle lamella
 4. Pyrenoids may be present, and in many taxa are stalked and cluster into a single mass
 5. Pigmented with Chlorophylls a and b
 6. Main secondary pigments are beta-carotene, neoxanthin, and diadinoxanthin
 7. Minor pigments include echinenone, diatoxanthin, and zeaxanthin
 8. Imported proteins are targeted first to ER, and subsequently to chloroplast
 9. Some nuclear-encoded, chloroplast expressed genes, including rubisco small subunits are translated and imported into the plastid as a polyprotein.
10. Makes sense in terms of secondary origin of plastid
- I. Food storage outside of plastid, as paramylon (a beta-1,3 linked glucan) granules

II. **Reproduction**

- A. Sex has not been observed, and it has been argued that euglenoids diverged from the eukaryotic main series prior to the evolution of sex. It is also possible that they are descended from sexual ancestors, but have lost sex, or that they do reproduce sexually, but do so discreetly.

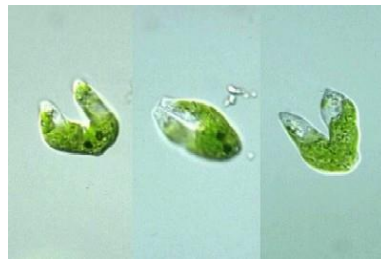

Figure 3. *Euglena* reproduction

III. **Ecology**

- A. Often found in highly eutrophic environments
- B. Ditches and ponds near cow pastures, hog lots, chicken farms, etc.
- C. A thick green or red scum on the surface of the water is often from a euglenoid bloom
- D. Mud flats (another highly productive environment) are also good euglenoid hunting
- E. Very few euglenoids have been grown in axenic culture, and euglenoid culture media are generally very nutrient rich

IV. **Economic Importance**

- A. Although an indicator group for disgusting environmental conditions, euglenoids are generally harmless.

LECTURE (5)

DIVISION: CHRYSOPHYTA

Chrysophyta, phylum (division) of unicellular marine or freshwater organisms of the kingdom Protista consisting of the diatoms (class Bacillariophyceae), the golden, or golden-brown, algae (class Chrysophyceae), and the yellow-green algae (class Xanthophyceae). In many chrysophytes the cell walls are composed of cellulose with large quantities of silica. Some have one or two flagella, which can be similar or dissimilar. A few species are ameboid forms with no cell walls. The food storage products of chrysophytes are oils or the polysaccharide laminarin. Formerly classified as plants, the chrysophytes contain the photosynthetic pigments chlorophyll *a* and *c*; all but the yellow-green algae also contain the carotenoid pigment fucoxanthin. Under some circumstances diatoms will reproduce sexually, but the usual form of reproduction is cell division. The diatoms and golden-brown algae are of great importance as components of the plankton and nanoplankton that form the foundation of the marine food chain.

Class: Xanthophyceae (ex., *Vaucheria*)

Genus of yellow-green algae. It is characterized by oil food reserves and tubular branches that have multiple nuclei and lack cross-walls except in association with reproductive organs or an injury. *Vaucheria* reproduce both asexually and sexually. The spherical female sex organ and the slender, hook-shaped male sex organ are usually produced on branches close to each other. After fertilization, the zygote may enter a resting phase for several weeks before developing into a new plant. Though most species occur in freshwater or are terrestrial, some are marine and others live in ice.

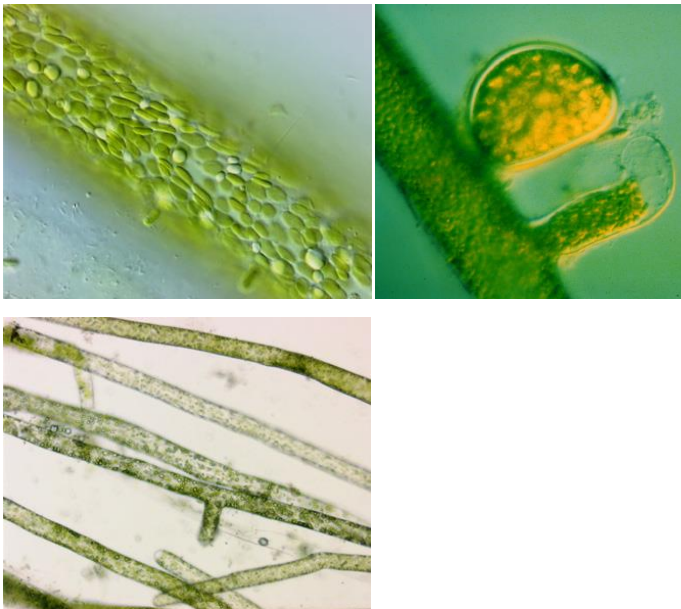

Figure 1. The filaments above have developed the beginnings of a branch, while the filament below has two long branches.

Vaucheria has siphonaceous, coenocytic filaments that can form felt-like mats, earning it the nickname "water felt". Cytokinesis does not usually follow mitosis, so the cells retain multiple nuclei. The thallus has cross walls only where gametes or zoospores were produced, and may be branched. The cytoplasm of *Vaucheria* is pushed to the cell periphery by large vacuoles, and contains many nuclei and discoid plastids. The plastids can change their orientation in response to changes in light levels. The large cells rely on cytoplasmic streaming to move materials around as needed.

Class: Bacillariophyceae (ex., Diatoms)

Diatoms are photosynthesising algae, regarded as the most beautiful of the algae. They have a siliceous skeleton (frustule) and are found in almost every aquatic environment including fresh and marine waters, soils, in fact almost anywhere moist. They are non-motile, or capable of only limited movement along a substrate by secretion of mucilaginous material along a slit-like groove or channel called a raphe. Being autotrophic they are restricted to the photic zone (water depths down to about 200m depending on clarity). Both benthic and planktic forms exist. Diatoms are formally classified as belonging to the Division Chrysophyta, Class Bacillariophyceae. The Chrysophyta are algae which

form endoplasmic cysts, store oils rather than starch, possess a bipartite cell wall and secrete silica at some stage of their life cycle. Diatoms are commonly between 20-200 microns in diameter or length, although sometimes they can be up to 2 millimeters long. The cell may be solitary or colonial (attached by mucous filaments or by bands into long chains). Diatoms may occur in such large numbers and be well preserved enough to form sediments composed almost entirely of diatom frustules (diatomites), these deposits are of economic benefit being used in filters, paints, toothpaste, and many other applications.



Figure 2. Diatoms

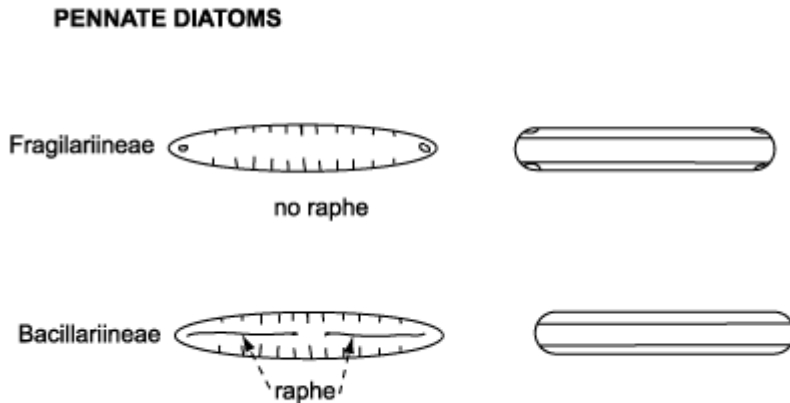

Figure 3. Schematic diagram of pennate diatom.

Cycle

When a cell divides each new cell takes as its epitheca a valve of the parent frustule, and within ten to twenty minutes builds its own hypotheca; this process may occur between one and eight times per day. Availability of dissolved silica limits the rate of vegetative reproduction, but also because this method progressively reduces the average size of the diatom frustules (glassy shell) in a given population there is a certain threshold at which restoration of frustule size is necessary. Auxospores are then produced, which are cells that possess a different wall structure lacking the siliceous frustule and swell to the maximum frustule size. The auxospore then forms an initial cell which forms a new frustule of maximum size within itself. Many neritic planktonic diatoms alternate between a vegetative

reproductive phase and a thicker walled resting cyst or statospore stage. The siliceous resting spore commonly forms after a period of active vegetative reproduction when nutrient levels have been depleted. Statospores may remain entirely within the parent cell, partially within the parent cell or be isolated from it. An increase in nutrient levels and/or length of daylight cause the statospore to germinate and return to its normal vegetative state. Seasonal upwelling is therefore a vital part of many diatoms life cycle as a provider of nutrients and as a transport mechanism which brings statospores or their vegetative products up into the photic zone. The resting spore morphology of some species is similar to that of the corresponding vegetative cell, whereas in other species the resting spores and the vegetative cells differ strongly. The two valves of a resting spore may be similar or distinctly different. Often the first valve formed is more similar to the valves of the vegetative cells than the second valve. This diversity of the valve types belonging to the same species calls for caution in identification work using cleaned diatom material.

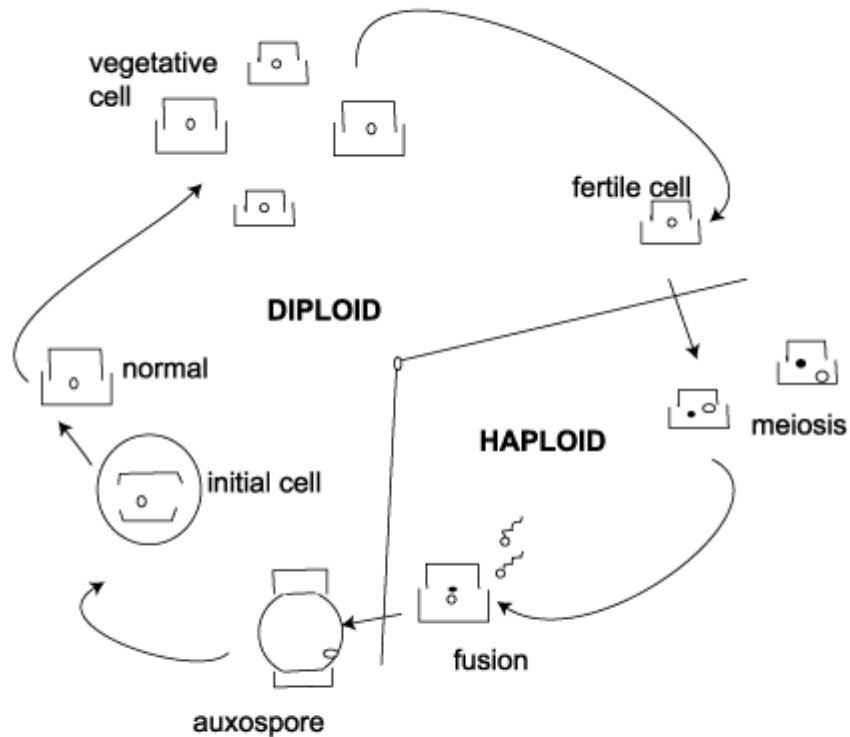

Diagram showing simplified life cycle of a typical diatom. The decrease in the average cell size of a diatom population requires at a certain point the restoration of cell size by the production of an auxospore in which the cell sheds its siliceous frustule. The resulting organic walled cell then produces a new maximal sized frustule within itself. The new first cell may differ from the normal vegetative cell in girdle structure, valve outline and process pattern.

Figure 4

The vegetative phase

As a result of the unique type of cell division in diatoms, average cell size decreases during the vegetative phase. In linear dimensions (e.g. the diameter of circular diatoms, the

length of bipolar diatoms), the smallest are often less than half the size of the largest. All cell divisions during the vegetative phase are mitotic and all vegetative cells are diploid.

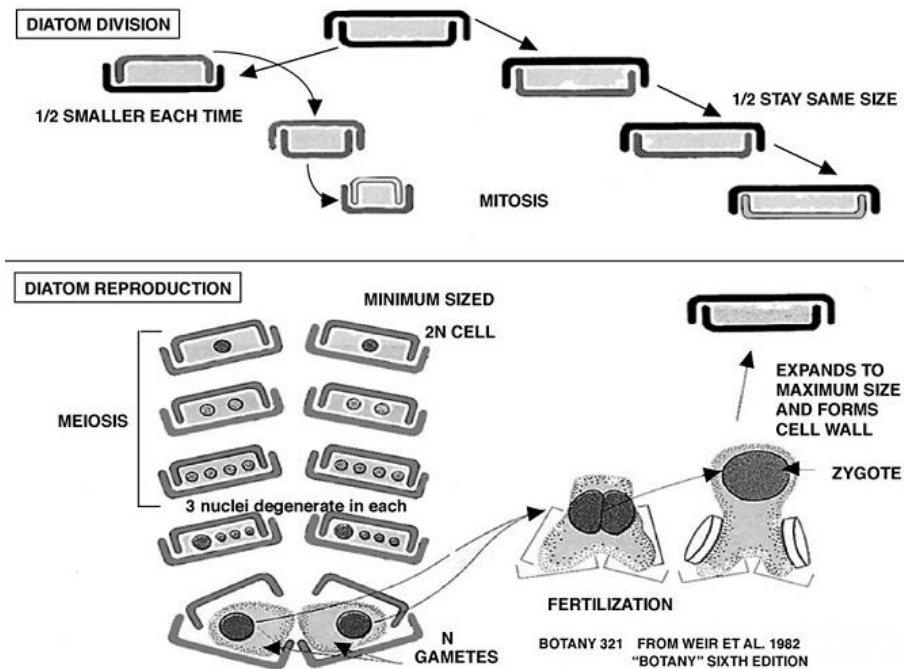

Figure 5

Diatoms are set up with a cell wall made up of silica and the diatom itself is a single-celled photosynthetic protist. Very little is known about how the cell wall is made, but scientists are researching it to hopefully find a way to the thin glass-like wall for nanotechnology. Diatoms are autotrophs, which means that is able to produce it's own sugars, lipids and amino acids. During the life cycle of the diatom the cell size

gradually shrinks as each valve produces a smaller complementary valve. (Reproduction generally occurs asexually because of this.) When the smaller valves have completely formed the two cells split. But because one side of the diatom is smaller when they split one is the same size as the original, while one is smaller. When they shrink to a certain size they have to produce sexually. To do this they create a auxospore which then will become a diatom. (see diagram above).

DIVISION: PHAEOPHYTA (Brown Algae)



Figure 1. Brown algae

Phaeophyta are greenish-brown colored algae that contain fucoxanthin, beta carotene and chlorophyll a and c. They are the most complex forms of algae, commonly adapted in marine environments.

Phaeophyta or brown algae are a group of autotrophic, multicellular organisms, belonging to the class Phaeophyceae of the division Chromophyta. They contain the xanthophyll

pigment - fucoxanthin, in addition to chlorophyll a and c. Hence, the members of phaeophyta exhibit a characteristic greenish-brown color. The brown colored pigment is very important for the adaptation of phaeophyta in deep seas and oceans. Phaeophyta are commonly adapted to marine environment, only a few phaeophyta are freshwater species. Phaeophyta are the most complex forms of algae. The cell walls are composed of cellulose and alginic acid (a complex polysaccharide). Unlike green algae or Chlorophyta, they lack true starch. The food reserves contain sugar, higher alcohol and other complex forms of polysaccharides. The members of phaeophyta belonging to Laminariales are called kelps.

Kelps are the only algae with a significant internal tissue differentiation. Though true conductive tissues like xylem and phloem are absent, kelps show some sort of conductive tissues. Speaking about the reproduction of phaeophyta, they can reproduce by means of both sexual and asexual means. Higher phaeophyta have life cycle consisting of both haploid and diploid stages, referred to as an alternation of generation. The thallus representing haploid stage and diploid stage may be similar (isomorphic) or different (heteromorphic).

Phaeophyta (Brown Algae): Uses

Commercially exploited phaeophyta include those belong to the orders, Laminariales and Fucales. Previously, marine seaweeds of phaeophyta are used for the extraction of iodine and potash. In recent times, phaeophyta are extensively exploited for the extraction of alginic acid. This alginic acid is used for deriving alginate, a major colloidal gel used as a stabilizer, emulsifier or binder in many industrial applications.

Commercially, alginate is used in fabric printing, baking, toothpastes, soaps, ice creams, meat preservation, etc. Another use of phaeophyta is in the manufacturing of agricultural or horticultural sprays. In addition, phaeophyta is used as a food source. The brown algae, laminaria is cultivated on man-made algal ponds (using ropes) for the production of food supplements and alginates. Harvested phaeophyta are then processed to prepare seaweed meals. These highly proteinaceous seaweed meals are exported to various countries, especially to solve the problem of malnutrition.

The Macroalgae

As well as phytoplankton (**microalgae**) there are the better known **seaweeds (macroalgae)** that cling to our shores. The term macroalgae simply refers to the algae that are easily

visible **without the requirement of a light microscope**. Macroalgae are distinct from the higher plants as they **lack any true vascular apparatus**. The macroalgae are restricted to regions along the coast that are **shallow** and which are relatively **free from destructive wave action**. They will be found clinging to rocks via their **holdfasts**, root like or disc shaped in appearance these holdfasts are for anchorage only and play **no role in nutrient/water absorption** as is seen in terrestrial plants, instead the alga absorbs nutrients and water over all of the its surface. From the holdfast rises the **stipe**, this is the “stem” of the seaweed. The stipe then leads to the **frond(s)**, which is commonly composed of the **midrib** and **lamina**. Some seaweeds will have **airbladders (aka pneumatocysts)** within the frond and **reproductive bodies (sporophyll)** that are terminal. Below is a typical seaweed, illustrating the typical features:

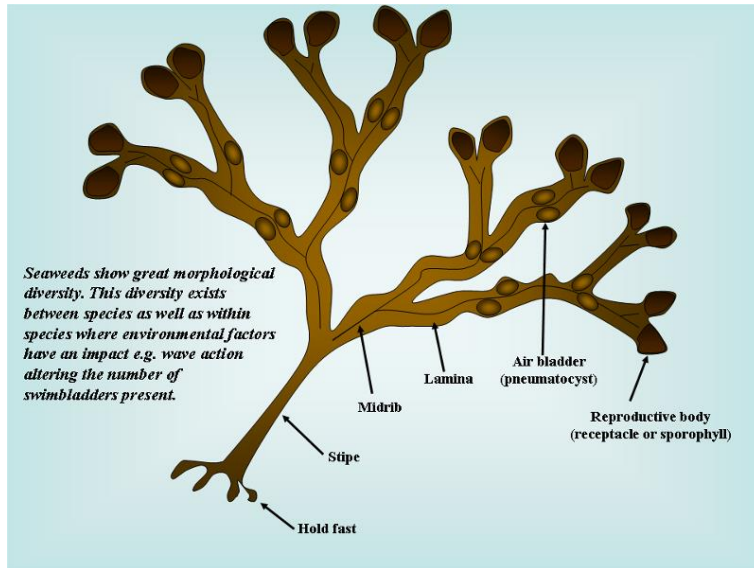

Figure 2. Diagram shows an idealized macroalga based upon *Fucus vesiculosus*.



Figure 3. The brown seaweed *Fucus vesiculosus*

Reproduction

Asexual reproduction

This is not very common. The only method of asexual reproduction shown by *Fucus* is fragmentation when parts which break away become established as new plants.

Sexual reproduction

This is the usual method of reproduction for the *Fucus*. *Fucus vesiculosus* is dioecious, i.e. separate male and female plants.

1. The tips of the fronds enlarge to form receptacles. Each receptacle contains conceptacles.
2. The gametes are formed in the conceptacles.
3. Meiosis in the antheridium followed by four mitoses produce sixty four haploid sperm cells.
4. Meiosis in the oogonium followed by one mitosis produces eight haploid egg cells (or oospheres).
5. When the tide is out the plant loses water, which causes it to shrink. The shrinking receptacles squeeze mucilage out of the conceptacles through the ostiole.
6. The mucilage carries the mature oogonia and antheridia onto the surface of the receptacles. The mucilage is secreted by the paraphysis.
7. When the tide comes in, the mucilage is washed away, the antheridia and oogonia rupture releasing the gametes into the open sea.
8. The egg cells being more dense than water sink to the bottom. The sperm cells swim and are attracted to the non-motile eggs by a chemical substance (chemotaxis). Many sperm may surround each egg.
9. One sperm enters and fertilises the egg. This results in a diploid zygote being formed.

10. The zygote germinates immediately. By mitosis and differentiation the zygote develops into a mature diploid plant.

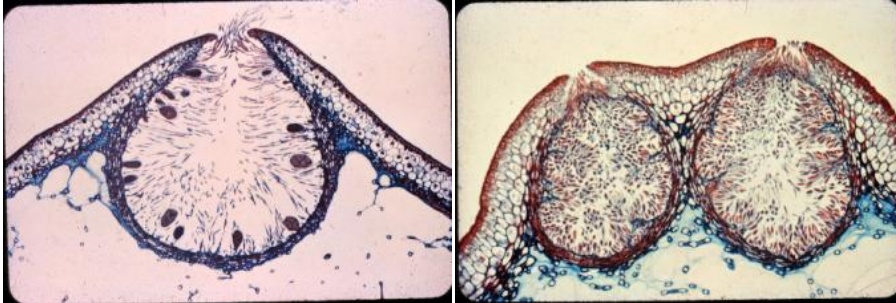

Figure 4. *Fucus* female conceptacle

Fucus male conceptacle

Adaptive features of the *Fucus*

Structural adaptations

- The holdfast anchors it to the rock.
- The air bladders increase the buoyancy of the plant (it stands upright into better light when the tide is in).
- Mucilage covers the plant which helps prevent desiccation when the tide is low.
- The thallus is tough and leathery which allows it to withstand wave action.
- The stipe and frond are flexible which allows it to bend with the waves (less likely to break).
- The presence of the brown pigment fucoxanthin allows the absorption of wavelengths of light that penetrate the water.

Life cycle adaptations

- It uses the tide going out to release the antheridia and oogonia onto the surface of the receptacles.
- It uses the tide coming in to release the gametes. The egg releases a chemical substance which attracts the sperm - chemotaxis.
- The sperm can swim using their flagella to the egg.

LECTURE (6)

KINGDOM: FUNGI

The **fungi** (singular, **fungus**) include several thousand species of eukaryotic, spore bearing organisms that obtain simple organic compounds by absorption. The organisms have no chlorophyll and reproduce by both sexual and asexual means. The fungi are usually filamentous, and their cell walls have **chitin** (vs. cellulose in plant). The study of fungi is called **mycology**, and fungal diseases are called **mycoses**.

Together with bacteria, fungi are the major decomposers of organic materials in the soil. They degrade complex organic matter into simple organic and inorganic compounds. In doing so, they help recycle carbon, nitrogen, phosphorous, and other elements for reuse by other organisms. Fungi also cause many plant diseases and several human diseases. Two major groups of organisms make up the fungi. The

filamentous fungi are called molds, made of strands called hyphae, a mass of hyphae is called mycelium. Multicellular hyphae that have separate cells are called septate, multinuclear hyphae that have no divisions between nuclei are called coenocytic while the unicellular fungi are called yeasts.

Nutrition mode

- Heterotrophs (non-photosynthetic).
- Some are saprophyte – secrete enzymes to decompose organic matter of dead organisms.
- Some are haustoria – obtain nutrients from living host

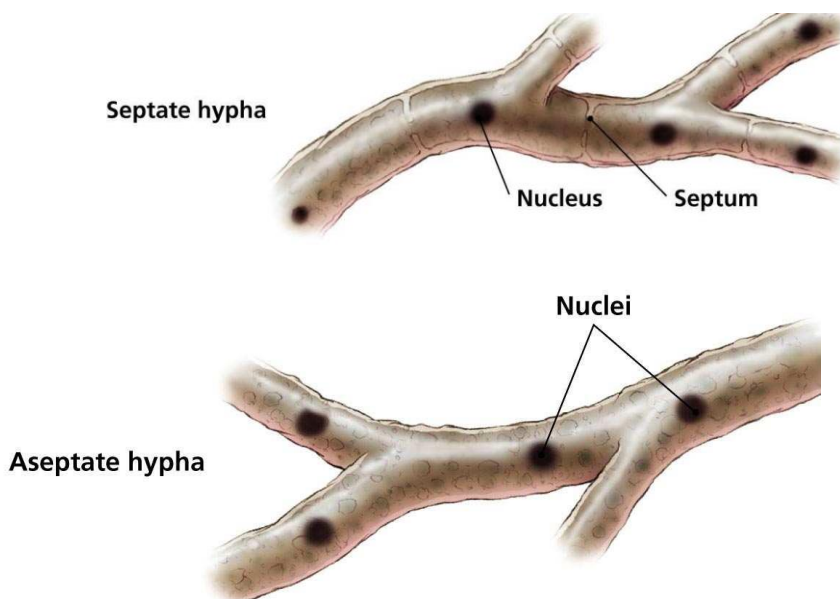

Figure 1.

Hyphal Ultrastructure

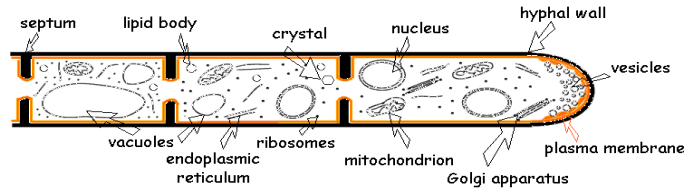

Figure 2. Diagram illustrating the ultrastructure of a septate hypha

Each HYPHA is:

- Essentially a tube - consisting of a rigid wall and containing protoplasm, tapered at its tip is the region of active growth (i.e. the extension zone).

SEPTA (cross-walls), if present, can usually be observed down a light microscope- some fungi possess septa at regular intervals along the lengths of their hyphae, in others, cross-walls form only to isolate old or damaged regions of a hypha or to isolate reproductive structures, some septa possess one or more PORES - such septa divide up the hyphae into a series of interconnected HYPHAL COMPARTMENTS, rather than separate, discrete cells.

The PLASMA MEMBRANE is closely associated with the hyphal wall and in some regions may even be firmly attached to it - making it difficult to plasmolyse hyphae.

Each hyphal cell or compartment normally contains one or more NUCLEI. In species whose septa possess a large central pore, the number of nuclei within a hyphal compartment won't remain static because the nuclei are able to pass between adjacent compartments, via the central septal pore. Other CYTOPLASMIC ORGANELLES are those commonly found in all eukaryotic cells.

The GROWING TIP is structurally and functionally very different from the rest of the hypha

- Its cytoplasm appears more dense
- There are no major organelles at the extreme tip
- At the extreme tip there is an accumulation of membrane-bound vesicles - the APICAL VESICULAR CLUSTER (COMPLEX) (AVC) - which plays an important role in apical growth.

VACUOLES may be visible in sub-apical hyphal compartments - although small at first, they grow larger and merge with one another; they store and recycle cellular metabolites, e.g. enzymes and nutrients. In the oldest parts of the hypha the protoplasm may breakdown completely, due either to AUTOLYSIS (self-digestion) or in natural environments HETEROLYSIS (degradation due to the activities of other microorganisms).

Reproduction of Fungi

- **Asexual:** budding (yeast), lightweight spores (filamentous)
- **Sexual:** sexual spores of the two sexual types fuse and involve exchanges of genetic material

- Asexual reproduction of Yeast

- budding
- Pseudohyphae may form

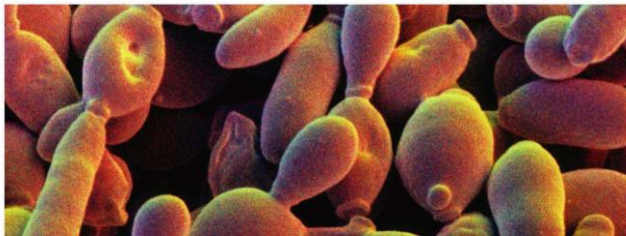

Figure 3. E.M. of yeast

Asexual spore formation in filamentous fungi

- Sporangiospore (sac)
- Chlamydospore (hyphae)
- Conidiospore (no sac)

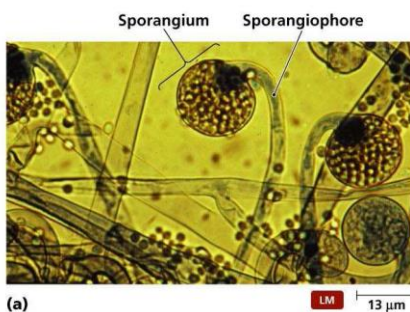



Figure 4. Sporangiphore, chlamydospore and conidophore
Classification of Fungi

Division Zygomycota. Members of the division **Zygomycota** are known as **zygomycetes**. Zygomycetes produce sexual spores known as **zygospores** (Figure 5), as well as asexual sporangiospores. A familiar member of the division is *Rhizopus stolonifer*, a fungus found on fruits, vegetables, and breads. It anchors itself to the substratum with special hyphae known as **rhizoids**. *Rhizopus* is used in the industrial production of steroids, meat tenderizers, industrial chemicals, and certain coloring agents.



Figure 5

During sexual reproduction, two haploid hyphae from different parents perform **plasmogamy**, joining together, producing a heterokaryotic cell. This multinucleate heterokaryotic cell forms a **zygosporangium**.

Pairs of nuclei (one from each parent) perform **karyogamy** in the zygosporangium, fusing to form a diploid nucleus. These diploid nuclei are **zygotes**; they immediately undergo meiosis to begin producing haploid **sexual spores**. A sporangium sprouts out of the zygosporangium to release these spores.

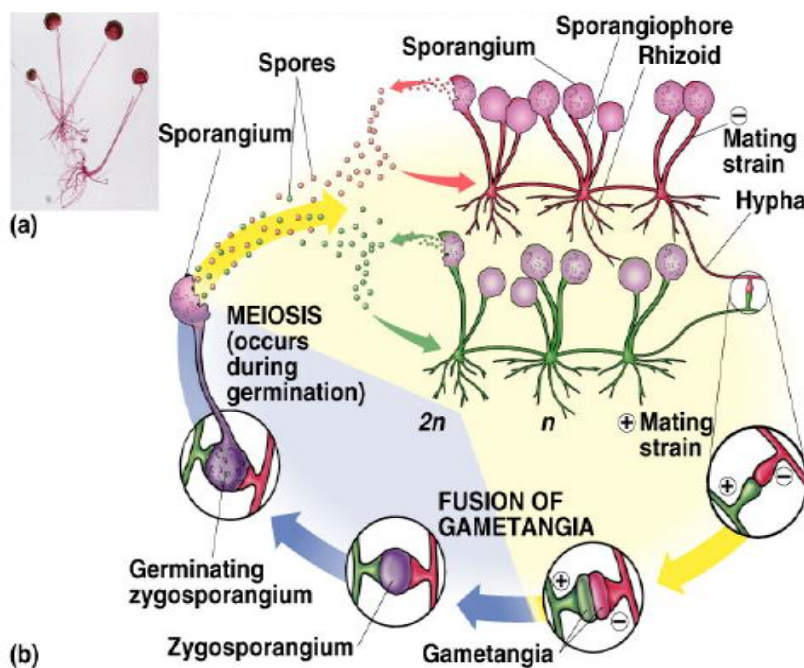

Figure 6. Sexual reproduction in the mold *Rhizopus stolonifer*. Plus and minus mycelia produce sexually opposite hyphae that fuse and give rise to zygospores, which germinate to form new mycelia.

Division Ascomycota.

Ascomycetes are 'spore shooters'. After sexual fusion of cells has taken place, these fungi produce microscopic spores inside special, elongated cells or sacs, known as 'asci', which give the group its name. As the spores mature within an ascus, increasing fluid pressure builds up inside until eventually the top bursts off, rapidly releasing the spores. In some species, the spores may be shot out distances of up to 30cm. Sometimes called cup fungi because of the shape of their reproductive structures. Has well developed dikaryotic stage. The ascocarp carries asci within cups. Nuclear fusion occurs within ascus, meiosis follows producing ascospores. Some species lack a sexual stage (e.g. *Penicillium*).

Ascomycetes include the powdery mildews and the fungi that cause Dutch elm disease and chestnut blight disease. Asexual reproduction in the ascomycetes involves conidia.

Many yeasts are classified in the division Ascomycota. Of particular interest is the **fermentation yeast** *Saccharomyces*. This yeast is used in the production of alcoholic drinks, in bread making, and as a source of growth factors in yeast tablets. It is an extremely important research organism as well.

Ascomycetes are very varied. They can be identified from the fruiting bodies which bear the asci and the way in which the asci develop.

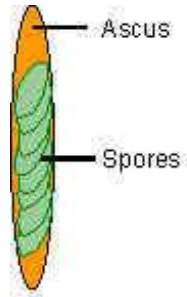

Figure 7. Fungi with spores produced inside a sac called an ascus.

Each ascus usually contains 8 spores.

There are two main groups of Ascomycetes with fruiting bodies large enough to catch the eye. The groups are separated according to how the asci are carried on the fruiting body.

- 1- **Cup Fungi, Morels** (Order Pezizales)
- 2- ***Cordyceps* fungi** (Order Clavicipitales)

Structure

Like basidiomycota, most ascomycota sprout from spores into haploid mycelia. These mycelia can produce two types of reproductive structures. First, they can produce conidiophores for asexual reproduction. Conidiophores may simply branch off from the mycelia or they may be formed in

fruiting bodies. Secondly, ascomycota produce structures for sexual reproduction called gametangia. These structures are either male or female. The male gametangia may be anything from a detached cell (called a spermatium) to a differentiated region called an antheridium. The female structure is always a differentiated region known as the ascogonium. Many Ascomycota form a fruiting body, or ascoma, similar to that of the Basidiomycota, but with an important difference. The ascomycota fruiting body is composed mainly of entangled monokaryotic hyphae from the male and female mycelia rather than of dikaryotic hyphae formed from the joining of hyphae from the two mycelia, as in the basidiomycota. The only dikaryotic structures in the fruiting body are those produced by the gametangia after plasmogamy.

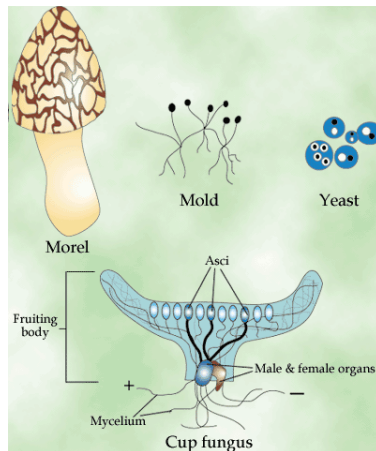

Figure 8. a) Some varieties of Ascomycota. b) Structure of the Ascomycota Fruiting Body

The exceptions to the above discussion of structure are the unicellular ascomycota or yeasts. These organisms are non-motile single cells with chitinous cell walls that earn them classification as fungi. Though they mainly reproduce by budding and fission, yeasts also engage in sexual reproduction that results in the production of an ascus, placing them in the Ascomycota. Most varieties of yeast do not form multicellular filaments like the mycelia and hyphae of other fungi, though they do live in massive groupings called colonies.

Reproduction

Like all fungi, Ascomycota can undergo both asexual and sexual reproduction.

Asexual Reproduction

Asexual reproduction among the different groups of fungi are very similar. Like Basidiomycota, Ascomycota reproduce asexually through budding or the formation of conidia.

Sexual reproduction

Ascomycota differs from that in the Basidiomycota and Zygomycota because Ascomycota have male and female gametangia in their haploid stage. These structures, form on

the mycelia. Plasmogamy, or the transfer of cytoplasm and nuclei, takes place when a part of the ascogonium, the trichogyne, fuses with the antheridium. This produces a binucleate, dikaryotic condition in the ascogonium. This phase is prolonged and a series of dikaryotic cells called an ascogonium hypha is produced. At the tip of this hypha, karyogamy or nuclear fusion takes place, resulting in the formation of a diploid ascus. Within this structure, the diploid nucleus undergoes meiosis, producing four haploid nuclei. These nuclei then undergo mitosis to form eight haploid ascospores. Notice that this is twice as many spores as produced in the basidium.

Yeast Reproduction

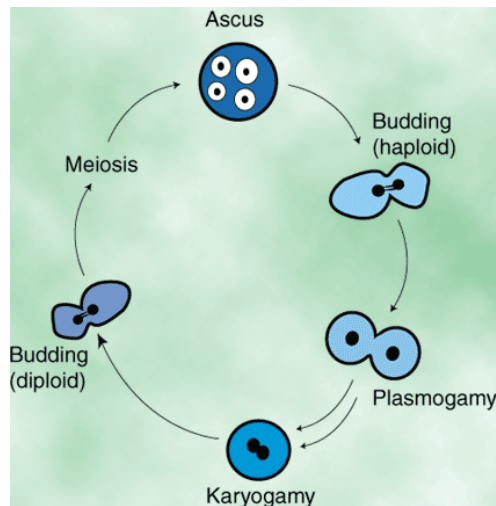

Figure 10. Life Cycle of Yeast

The different kinds of yeast most commonly reproduce by budding and fission, both forms of asexual reproduction.

Budding occurs when a small portion of the cytoplasm of the parent cell becomes separated into small daughter cell. Fission involves an equal division of the cytoplasm into two daughter cells. Yeast can also reproduce sexually, and usually do so under starvation conditions. Most yeast have two mating types. In the most commonly studied species, *Saccharomyces cerevisiae*, these are designated *a* and *alpha*. When yeast of opposite mating types meet, the cells fuse (plasmogamy), followed by the fusion of their nuclei (karyogamy). This diploid cell can produce more diploid cells by budding. Eventually, a diploid cell will become an ascus and enter meiosis. This produces four haploid nuclei that are then surrounded by thick protective coats and become spores. These spores are released and become new haploid cells.

Aspergillus

Aspergillus is a typical mold. A mold is a fungus with a body composed of thin, stringy **hyphae**. The whole body of connected hyphae is called a **mycelium**. The mycelium is haploid, except for reproductive structures.

Various species of *Aspergillus* are used commercially, for example in the production of citric acid or digesting the

starch in rice as a step in making sake. Some species of *Aspergillus* occasionally act as human pathogens.

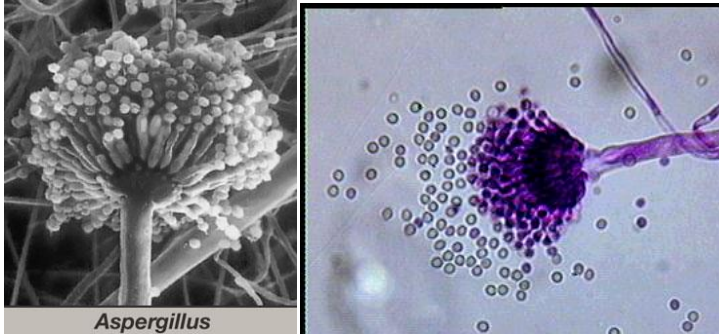

This electron micrograph shows a spore-producing structure (called a conidiophore), with numerous spores being produced.

Molds can spread rapidly because their thin hyphae penetrate into new food sources (rotting fruit, for example) and can grow very rapidly. Molds can also produce huge numbers of asexual spores via mitosis.

Molds also reproduce sexually, but this is much less common than asexual spore formation.

Penicillium

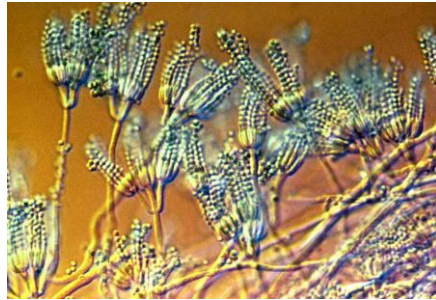

Figure 11. *Penicillium italicum* and *Penicillium digitatum* on Orange

The name *Penicillium* comes from penicillus = brush, and this is based on the brush-like appearance of the fruiting structures (above right) under the microscope.

Penicillium typically produces these brush-like heads. The stalk is called the conidiophore. The conidiophore branches at the tip. At the end of each branchlet is a cluster of spore-producing cells called phialides. A chain of spores is formed from the tip of each phialide. The spore is called a conidium Or phialsopore. The spores in *Penicillium* often contain blue or green pigments which give the colonies on foods and feeds their characteristic colour. It is the spores in the blue cheese that give the colour to the cheese. The spores are only a few microns in diameter. I wonder how many millions of spores are eaten in a serving of blue cheese. How would you figure it out? (hint: need a haemocytometer).

This orange (above left) was inoculated with two species of *Penicillium* at the same time. The smaller bluish colony is *Penicillium italicum*. The larger olive-green colony is *Penicillium digitatum*. These are the two common species of *Penicillium* attacking citrus fruits.

For the most part *Penicillium* species like the temperature on the cool side. *Penicillium* is a versatile, opportunistic fungus with an arsenal of useful enzymes at its disposal to attack a host of organic foodstuffs. So, you have probably already seen it a number of times on food left a little too long in the fridge. It is partial to bread, cheese, cold meats, old sandwiches, cereal products and a host of other things.

If you are a farmer and store your cereals in bins then *Penicillium* is a dangerous adversary. If the percentage moisture in your cereal is too high then *Penicillium* will happily destroy it. While it is growing in the feed, the fungus can produce dangerous toxins (mycotoxins) in the cereal residues than can cause serious deleterious effects in animals consuming contaminated feed.

Even fruit farmers can't escape the ravages of *Penicillium*. *Penicillium expansum* causes a soft rot of apples. The rotted part of the apple contains a mycotoxin called **patulin** produced by the fungus. If such apples are squeezed for juice then the patulin persists in the juice. So, apples with

brown rot should never be used for apple juice. The mycotoxin patulin is a broad spectrum antibiotic and suppresses both gram positive and gram negative bacteria as well as other fungi. *Penicillium* species break down food products by external secretion of enzymes. The production of antibiotics will inhibit competition and protect the substrate for the exclusive use of the *Penicillium*. At least for a little while.

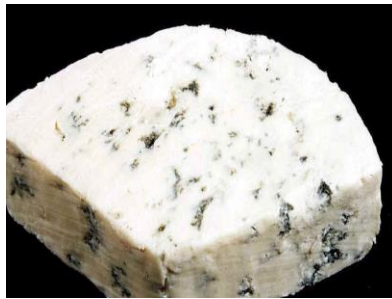

Figure 12. blue-cheese have *Penicillium roquefortii*

Penicillium isn't all bad, however. On the plus side we have *Penicillium roquefortii* used in the manufacture of blue cheese. During the fermentation process the fungus imparts a pleasant tang to the final product. By the way, the blue in the blue-cheese is caused by the pigment in the spores (conidia) of the fungus. You are consuming spores by the million when you eat blue cheese. Hope it doesn't put you off! Also, let us not forget the contributions of *Penicillium notatum* and *P. chrysogenum* in the production of the antibiotic penicillin.

Peziza

Figure 14

Peziza is a cup fungus in the phylum Ascomycotes. Like a mushroom (phylum Basidiomycota), *Peziza* produces above-ground heterokarkyotic reproductive structures that come from an underground mycelium.

One way that *Peziza* differs from mushrooms is that it produces spores on top of its cup, not underneath like a mushroom.

In cross-section, *Peziza* shows a mycelium constructed of loose hyphae underneath, with tightly packed spore-producing structures (called asci) on top.

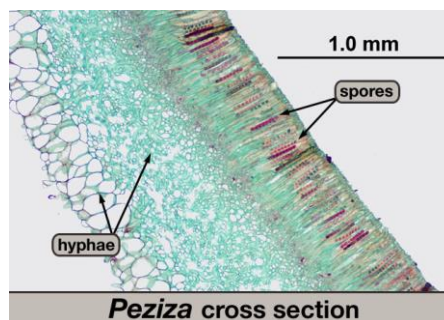

Figure 15.

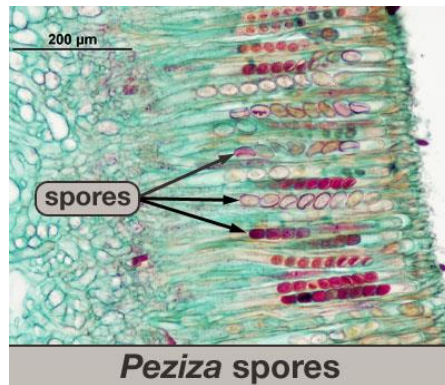

Figure 16.

In this image, each ascus is a long, narrow cell with eight spores inside. The ascus begins as a single dikaryotic cell. The two nuclei fuse, forming a single diploid nucleus; this is called **karyogamy**. The diploid nucleus is called a **zygote**. The zygote undergoes meiosis, producing four haploid nuclei. Each of these haploid nuclei divides once (via mitosis). The end result is eight haploid nuclei in one ascus; these nuclei form new walls and turn into spores. In this image, you can see spores at different stages of maturation.

LECTURE (7)

Division Basidiomycota.

Members of the division **Basidiomycota** are referred to as **basidiomycetes** and are called **club fungi**. After the sexual cells have united, they undergo division and produce a clubshaped structure called a **basidium**. Sexually produced

basidiospores form at the tips of the basidia. Basidia are often found on huge, visible, fruiting bodies called **basidiocarps**. The typical **mushroom** is a basidiocarp.

Basidiomycetes are used as food (for example, mushrooms), but some basidiomycetes are pathogens. One of the organisms of meningitis is the basidiomycete *Cryptococcus neoformans*. The mushroom *Amanita* is poisonous to humans.

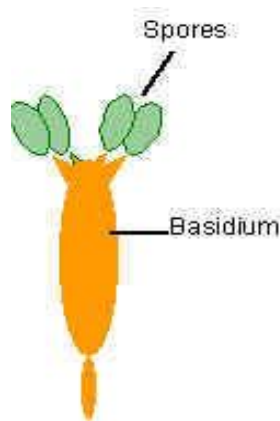

Fig. 17 Fungi with spores produced externally, on specialized cells called basidia. Typically, there are 4 spores per basidium, although this varies from 1 to many, depending on the species.

Puccinia graminis

In *Puccinia graminis* (Wheat Rust), there are five spore stages that are produced and two hosts are required in the completion of the life cycle. The five stages produced are:

- Stage 0: Spermogonium
- Stage I: Aecium

- Stage II: Uredium
- Stage III: Telium
- Stage IV: Basidium

As a means of comparing the life cycle of *Puccinia graminis* with that of the mushroom life cycle, a summary of the life cycle will begin with the basidiospore.

Basidium (Stage IV)

Puccinia graminis is heterothallic and **basidia** produce **basidiospores** that are of two mating types, designated as 18 and 19, Basidiospores are capable of only infecting the leaves of *Berberis sp.* (barberry), the **alternative host** for this species. Species that require two hosts to complete their life cycles are said to be **heteroecious**. The cells of the **teliospore** germinates to produce a short germ tube that will develop into a basidium that is essentially transversely septate.



Figure 18: Basidia and basidiospores are produced from germinating teliospores. The basidium is very similar in appearance to the transversely septate basidia that is present in the Auriculariales of the Basidiomycetes

Spermogonium (Stage 0)

The spermogonium stage (Fig. 19) produces the sex organs in rusts. They are produced on the *upper* surface of the *Berberis* (barberry) leaf. Since the spermogonia are derived

from basidiospores, they are of two mating types. They are flasked-shaped and produce spore-like **spermatia** which ooze out, from the neck, in a sweet-smelling nectar. Also growing from the necks are **receptive hyphae**. The spermogonia are visited by flies which are attracted by the nectar secretions, and as they visit different spermogonia, spermatia of both mating types, adhere to their bodies and are transferred to receptive hyphae of the other mating types. This begins the dikaryon stage of the life cycle.

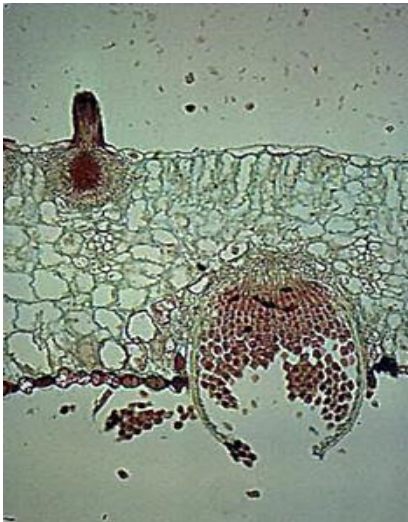

Figure 19. The spermogonium stage of *Puccinia graminis* forms on the upper surface of the *Berberis* leaf. Structure on the lower surface of the leaf is the aecium, the next spore stage in the life cycle. This spore stage does not form unless spermatia of one mating strain fertilize the receptive hyphae of a different mating strain.



Figure 20: A high magnification of the spermatogonium stage. The spermatogonium is flask-shaped. The spermatia are borne at the base of the spermatogonium. The upright hyphae are the receptive hyphae.

Aecium (Stage I)

The aecium stage is directly linked to the spermatogonium stage. When spermatia are transferred to compatible receptive hyphae, this begins the dikaryotic stage of the life cycle and directly produces the aecium on the *lower* surface of the barberry leaf. The aecium is an upside-down, sac-shaped structure (Fig. 21) in which chains of **aeciospores** are formed. The aeciospores burst through the lower surface of the leaf and are dispersed by wind.

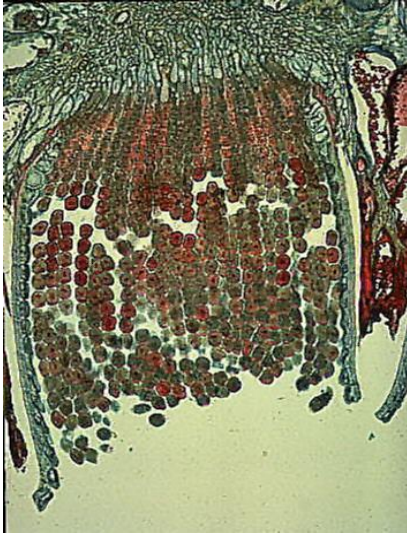

Figure 21. Aecium stage emerging from the lower surface of the *Berberis* leaf. The aeciospores are borne in chains and are held together by little rectangular cells called disjunctors.

Uredium (Stage II)

The aeciospores cannot reinfect the barberry host. Instead infection can only occur on the primary host, *Triticum aestivum* (wheat), where a new dikaryotic infection occurs. When two hosts are required in the completion of a rust life cycle, the rust is said to be **heteroecious**. The wheat is said to be the **primary host** while barberry is said to be the **alternate host**. The dikaryons infect the wheat stems and leaves and will form **uredia** that contain orange-brown **urediospores** (Fig. 22). This order is commonly called the rusts because of the orange-brown (rusty) colored pustules that form on the wheat plant after the urediospores have broken through the epidermal surface. The urediospores are comparable to conidia in that they will reinfect wheat plants and produce more uredia and urediospores. This stage begins

during summer and continues until late summer in North America.

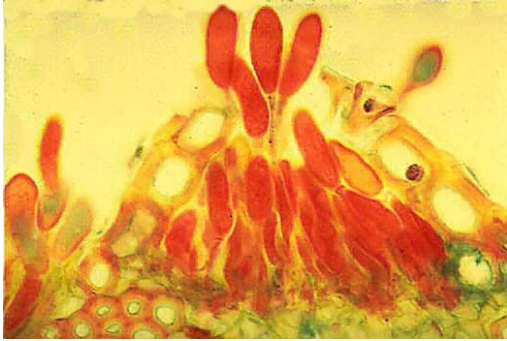

Figure 22. A prepared slide showing the rust spores as they break the host epidermis. This is the repeating stage of the life cycle and continually reinfects wheat from early spring to summer.

Telium (Stage III)

Towards the end of summer, the uredium begins to produce **teliospores** (Fig. 23), a dark, thick-walled, two celled spore. Teliospores do not produce telia! It is the uredium that gradually becomes a telium by producing more and more teliospores. Because of the color of the teliospores, the telium is black. Following karyogamy, the teliospore overwinters. Meiosis takes place in each cell of the teliospore, in spring, and germinates to form the **promycelium** (=basidium). The promycelium becomes transversely septate, forming four cells. Each cell produce a sterigma and a basidiospore, and this now completes the life cycle.



Figure 23. Teliospores, on the wheat plant. The teliospores are dark, two celled, thick walled spores. These spores overwinter before producing the basidiospore stage.

Order: **Agaricales**



This is the order of Basidiomycetes with which most of us are familiar. This is the order that is commonly referred to as mushrooms. Basidiocarps of this order typically are "fleshy" and have a **stipe** (=stalk), **pileus** (=cap), and **lamellae** (=gills) where the basidia and basidiospores are borne (Fig. 1-4). The Basidiospores in this order of fungi are forcibly ejected from the basidium, into the area between the lamellar edges, which then allows the spores to fall free from the mushroom and be dispersed by wind.

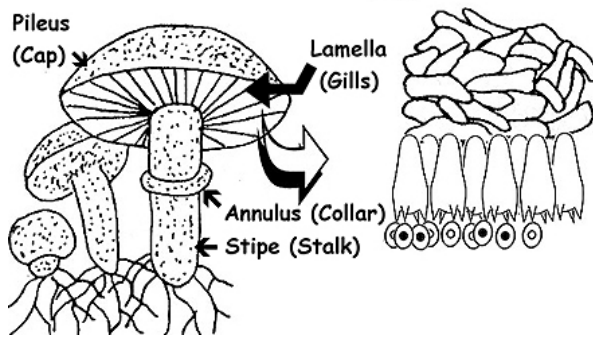

Figure 25: Typical mushroom of Agaricales: Stipe, annulus, lamella and pileus. Basidia and basidiospores are produced in an hymenium on the lamella surface.



Figure 26: Low magnification of a cross section through the lamella of a mushroom

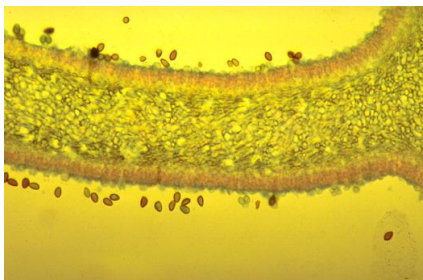

Figure 27: Higher magnification of section through the lamella of mushroom.

Basidiospores now visible on the upper and lower edge of lamella.



Figure 28: High magnification of basidia. Center basidium shows two basidiospores of four on sterigmata.

The mushroom life cycle will be used as representative of the basidiomycete life cycle.

Mushroom Life Cycle

The mushroom basidiocarp is typically composed of a stipe that elevates the basidiocarp above the substrate, a pileus and in some species a partial veil that encloses and protects the lamella as the basidia and basidiospores are developing (Fig 29-30).

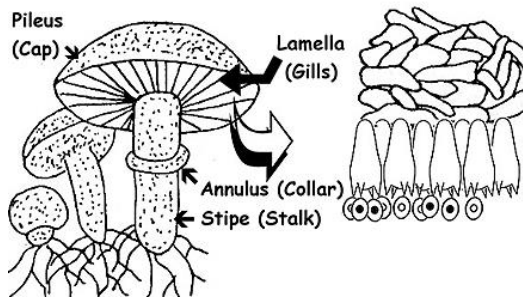

Figure 29: Various stage of mushroom development (right) and mature, haploid basidiospores on basidia on the surface of the lamella.



Figure 30: Mature basidium with haploid basidiospore that are typically of different mating strains.

The mushroom life cycle is similar to that of the filamentous Ascomycota in that following monokaryon formation, there is a prolonged dikaryon stage prior to karyogamy. However, a significant difference is that sexual organs are absent. It is thought that sexual organs of Basidiomycetes were lost during their evolution and that vegetative hyphae have taken over the function of sexual organs. Dikaryon formation begins with the fusion of hyphal cells between compatible monokaryons (Fig. 31). The monokaryon stage of

the Basidiomycotina is short-lived and fusion with a compatible monokaryon occurs soon after basidiospore germination. The dikaryon is the mycelium that produces the basidiocarp, and as in the Ascomycota, only certain dikaryotic cells will function in basidia and basidiospore formation, e.g. dikaryotic cells in the hymenium (Fig. 32).

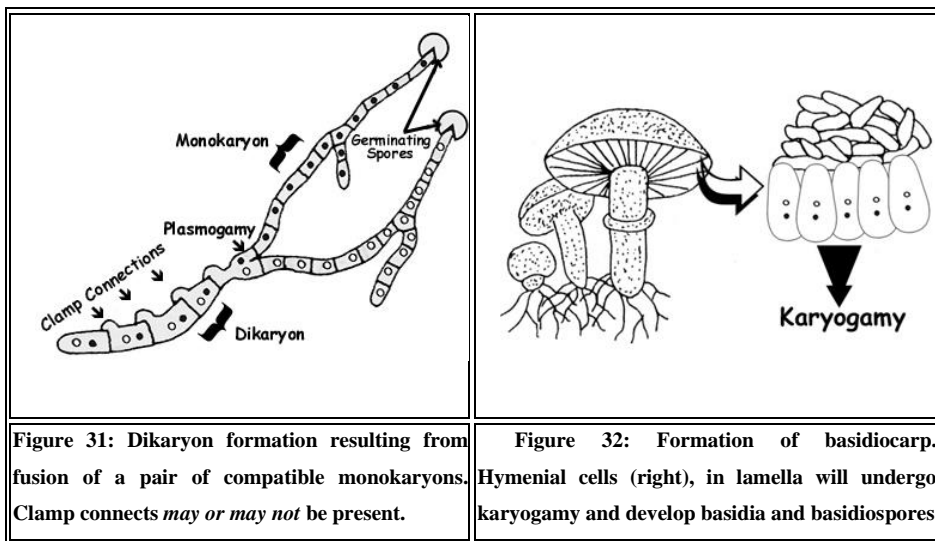

Figure 31: Dikaryon formation resulting from fusion of a pair of compatible monokaryons. Clamp connects may or may not be present.

Figure 32: Formation of basidiocarp. Hymenial cells (right), in lamella will undergo karyogamy and develop basidia and basidiospores

The terminal cells develop into basidia and are where karyogamy will take place to form the zygotes. The zygote is the only diploid stage in the life cycle. The zygote immediately undergoes meiosis to form four haploid nuclei, and the future basidiospores are formed as blown out structures, on the tips of sterigmata, of the basidium. The nuclei migrates into the blown out areas which may then be properly referred to as basidiospores (Fig. 33).

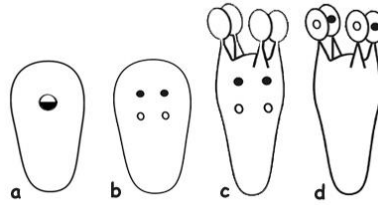

Figure 33: The zygote 33a is the only diploid stage. Four nucleate stage after meiosis 33b. Formation of basidiospores, but nuclei have not migrated into spores 33c. Nuclear migration into basidiospores 33d.

LECTURE (8)

Division Deuteromycota. Members of the **Deuteromycota** division are called **deuteromycetes**. These fungi lack a known sexual cycle of reproduction and are said to be “imperfect.” When its sexual cycle is discovered, a fungus from this division is usually reclassified in one of the other divisions. Among the imperfect fungi are the organisms of athlete's foot and ringworm.

The Deuteromycota are characterized by production of septate mycelium and/or yeasts, and a sexual life cycle that is either unknown or absent. Asexual reproduction is by means of **conidia** (sing.=conidium) or may be lacking. A conidium may be defined as an asexual spore that is not produced in a sporangium. Where sexual reproduction has been determined for species in this taxon, the sexual stage is usually referable to the Ascomycota or Basidiomycota. Ideally, once the

sexual stage has been determined, that species should be reclassified and placed in the appropriate subdivision. However, this did not prove to be practical since many species are known best by their asexual stage. Thus, a compromise was reached and both the asexual and sexual stage are recognized. As previously discussed in the Ascomycota, when both sexual and asexual stages are known to occur in a life cycle, they are referred to as **telomorph** and **anamorph**, respectively.

Conidia and conidiophore produced on mycelium (Fig. 34-35).



Figure 34: Conidiophores of *Ulocladium* and a single conidium. Conidia in this order are produced directly on hyphal cell or specialized hyphal cells called conidiophores.



Figure 35: Conidia of *Alternaria tenuis* are borne in chains

Lichens - Dual Organisms

Lichen is two different organisms living in a close symbiotic association. One partner is a fungus, which forms a tough,

leathery coating that provides a protected space inside. The fungal cells can tolerate harsh, dry conditions, but they cannot produce food on their own. The other partner is an alga -- a unicellular photosynthetic organism. The algae thrive in the protected environment created by the fungal mycelium. The algae perform photosynthesis, making the sugars that can be used as energy by both the algae and the fungus.

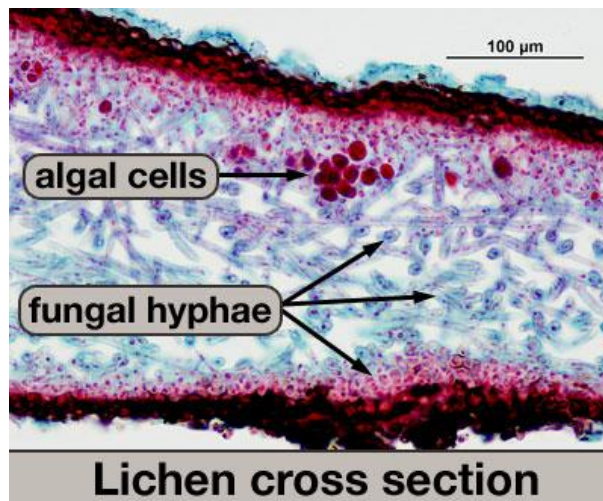

Figure 1.

Lichens occur in one of four basic growth forms, as illustrated below:

- **crustose** - crustlike, growing tight against the substrate.
- **squamulose** - tightly clustered and slightly flattened pebble-like units.

- **foliose** - leaflike, with flat sheets of tissue not tightly bound.
- **fruticose** - free-standing branching tubes.

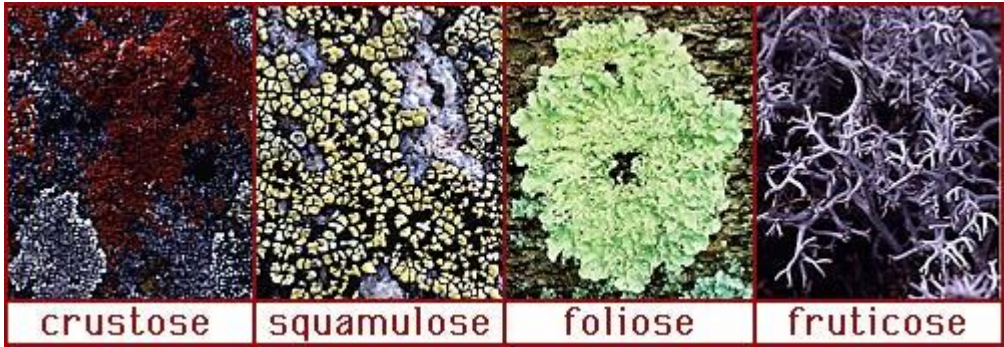

Figure 2. Different shapes of Lichens

Despite the wide diversity of the basic growth forms, all lichens have a similar internal morphology. The bulk of the lichen's body is formed from filaments of the fungal partner, and the relative density of these filaments defines the layers within the lichen.

At its outer surface, where it comes in contact with the environment, the filaments are packed tightly together to form the **cortex**. The dense cortex serves to keep out other organisms, and helps to reduce the intensity of light which may damage the alga cells.

The algal partner cells are distributed just below the cortex in a layer where the fungal filaments are not so dense. This is very similar to the arrangement in a plant leaf, where the photosynthetic cells are loosely packed to allow air circulation.

Below the algal layer is the **medulla**, a loosely woven layer of fungal filaments. In foliose lichens, there is a second cortex below the medulla, but in crustose and squamulose lichens, the medulla is in direct contact with the underlying **substrate**, to which the lichen is attached.

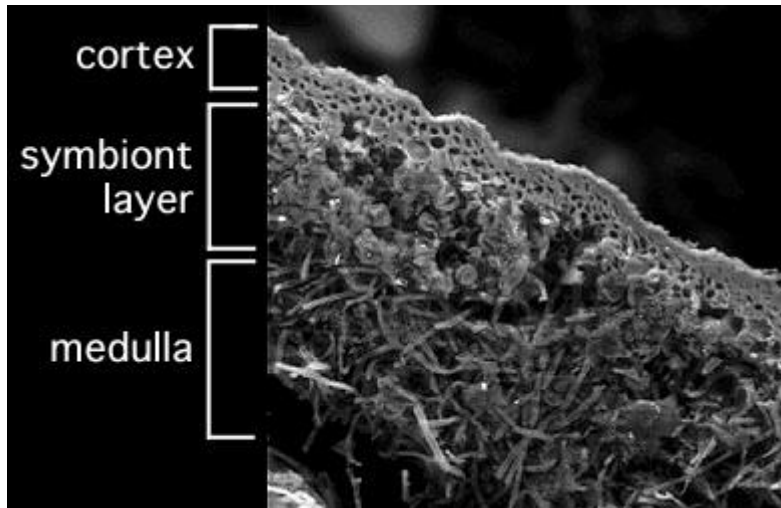

Figure 3. E.M. for cross section of lichens



Figure 4. crustose lichens on tree bark.

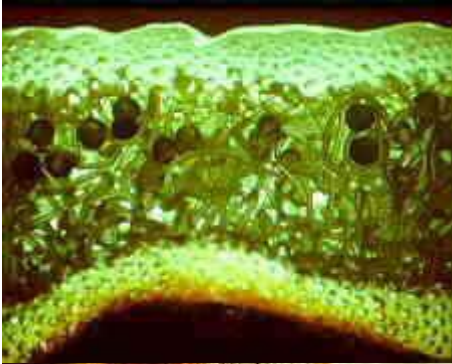

Figure 5. model of a lichen thallus, showing round algal cells among fungal hyphae.



Figure 6. foliose and crustose lichens on rock.

المراجع :

1. الفالح، عبدالله مساعد وعياش، عبدالكريم (1424هـ). أساسيات علم تقسيم النبات، دار الخريجي للنشر والتوزيع، الرياض، المملكة العربية السعودية.
2. علم النبات العام للدكتور احمد مجاهد وآخرون مكتبة الانجلو المصرية القاهرة .
3. المملكة النباتية للدكتور حسين العروس دار المطبوعات الحديثة الاسكندرية

REFERENCES

General

- Bell, P.R. (1982). Green plants: their origin and diversity. Cambridge Univ. Press, Cambridge.
- Bold, H.C., La Clarie, J.W. (1987). The Plant Kingdom. Prentice-Hall, Inc., Englewood Cliffs, NJ.
- Kaufman, P.B., Carlson, T.F., Dayanandan, P., Evans, M.L., Fisher, J.B., Parks, C. & Wells, J.R. (1989). Plants: their biology and importance. Harper & Row Publishers, New York.
- Marsulis, L. & Swartz, K.V. (1988). Five Kingdoms. W.H. Freeman & Co., New York.

Moore, R. *et. al.* (1995). Botany Vol. 2 Plant Diversity. Wm. C. Brown Publ.

Raven, P, Evert, RF & Eichhorn, SE (1999). Biology of Plants. W.H. Freeman & Co., New York.

Advanced or specific topics

Barinaga, M. (1995). Origin of lichen fungi explored. Nature 268: 1437.

Bhattacharya, D. & Medlin, L. (1998). Algal phylogeny and the origin of land plants. Plant Physiol. 116: 9-15.

Chaloner, B. (1989). A missing link for seeds? Nature 340: 185.

Chaloner, W.G. & MacDonald, P. (1980). Plants invade the land, HMSO, Edinburgh.

Chapman, A.R.O. (1987). Functional diversity of plants in the sea and on land. Jones & Bartlett Publ. Inc., Boston.

Chisholm, JRM, Dauga, C, Ageron, E, Grimont, PAD & Jaubert, JM (1996) 'Roots' in mixotrophic algae. Nature 381: 382.

Ingold, C.T. (1974). Spore liberation in Cryptogams. Oxford University Press, Oxford.

Keeley, J.E., Osmond, C.B. & Raven, J.A. (1984). *Stylites*, a vascular land plant without stomata absorbs CO₂ via its roots. Nature 310: 694-695.

Kenrick, P. & Crane, P.R. (1997). The origin and early evolution of plants on land. Nature 389: 33-39.

Lodge, D.L. (1993) Cycads of the world. Smithsonian Institution Press, Washington.

Niklas, K.J. (1997). The evolutionary biology of plants, University of Chicago Press, Chicago & London.

Page, C.N. (1979). Experimental aspects of fern ecology, pp. 551-589 in Experimental biology of ferns,
Ed. A.F. Dyer, Academic Press, London.

Page, C.N. (1979). The diversity of ferns. An ecological perspective, pp. 9-56 in Experimental biology of ferns, Ed. A.F. Dyer, Academic Press, London.

Paolillo, D.J. (1981). The swimming sperms of land plants. BioScience 31: 367-373.

Qiu, Y-L. & Palmer, J.D. (1999) Phylogeny of early land plants: insights from genes and genomes. Trends in Plant Science 4: 26-30.

Raubeson, L.A. & Jansen, R.K. (1992) Chloroplast DNA evidence on the ancient evolutionary split in vascular land plants. Science 255: 1697-1699.

Richardson, D.H.S. (1981). The biology of mosses. Blackwell Sci. Publ.

Schiebinger, L. (1996) The loves of plants. Scientific American (Feb.) 110-115.

Schierer, D.C. (1980) Differentiation of bryophyte conducting tissues: structure and histochemistry. Bulletin of the Torrey Botanical Club 107: 298-307.

Sze, P. (1986). A biology of the algae. Wm. C. Brown. Publ., Boston.

Tang, W. (1987) Heat production in cycad cones. Botanical Gazette 148: 165-174.

Thomas, B. (1981). The evolution of plants and flowers. Peter Lowe.

Wiebe, H.H. (1978) The significance of plant vacuoles. BioScience 28: 327-331.

Wolfe, G.R., Cunningham, F.X., Durnford, D., Green, B.R. & Gantt, E. (1994) Evidence for a common origin of chloroplasts with light-harvesting complexes of different pigmentation. Nature 367: 566-568.

الدروس العملية في المملكة النباتية

اعداد

اعضاء هيئة التدريس بقسم النبات والميكروبيولوجي

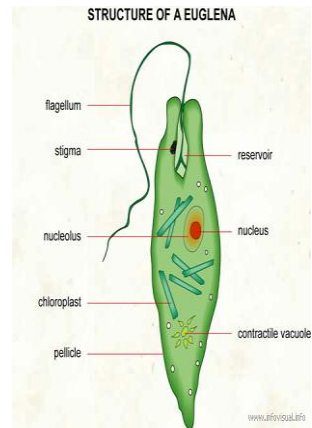
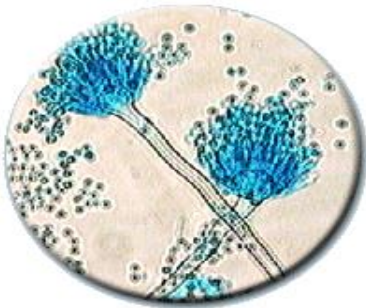

Microscope

Study the different parts of the microscope, with the aid of the plate.

❖ **Preparation of material for examination:**

Place a drop of water on a clean slide. The material to be examined is placed in this water. With the edge of the clean cover slip touching this water and tilted at an angle with slide, drop the cover slip until no air bubbles are formed. Blot off any excess water.

❖ **General remarks on using the microscope:-**

- 1- Before using the microscope be sure all lenses are clean.
- 2- Always, keep the stage clean and dry.
- 3- Move the mirror before the test to provide the best illumination and the best image.
- 4- To study an object use first the low power and then high power. Do not use the latter before putting a cover slide.
- 5- When you use the high power, use only the fine adjustment.
- 6- Use both your eyes when looking in the microscope.

الميكروسكوب

ادرس اجزاء الميكروسكوب وذلك بالاستعانة بالرسم الموجود امامك.

طريقة تجهيز عينة للفحص ميكروسكوبيا:

ضع نقطة ماء علي شريحة نظيفة ثم ضع العينة المراد فحصها علي نقطة الماء ثم امسك الغطاء cover بين الاصبعين في وضع مائل ثم تخفض تدريجيا حتي يلامس سطح نقطة الماء بحيث يكون مرتكزا علي جانبه لتلافي تكوين فقاعات هوائية.

ارشادات عامة لاستعمال الميكروسكوب:

- 1- قبل استعمال الميكروسكوب نظف جميع عدساته بورق تنظيف العدسات الخاص, ويجب تجنب استعمال القماش أو القطن أو ورق التنشيف, لانه قد يخدش العدسات كما انه قد يترك عليها وبراً مما يسبب عدم وضوح الرؤية بالمجهر.
- 2- دائما اجعل المسرح او المنصة نظيفا وجافا.
- 3- حرك المرآة قبل الفحص للحصول علي احسن اضاءة.
- 4- افحص العينة اولا بالقوة الصغري ثم الكبرى ولا تستعمل القوة الكبرى دون استعمال غطاء للشريحة.
- 5- عند استعمال العدسة الكبرى استعمل الضابط الصغير او الدقيق فقط.
- 6- استعمل كلتا عيناك عند النظر في الميكروسكوب.
- 7- أعد العدسة الشبئية الصغري الي مكانها بعد الانتهاء من الفحص.
- 8- يجب إطفاء المجهر في حالة عدم استخدامه.
- 9- أعد المجهر إلي خزانته بعد وضع غطاءه عليه, حتي يظل نظيفا للاستعمالات الاخرى.

تركيب الميكروسكوب الضوئي

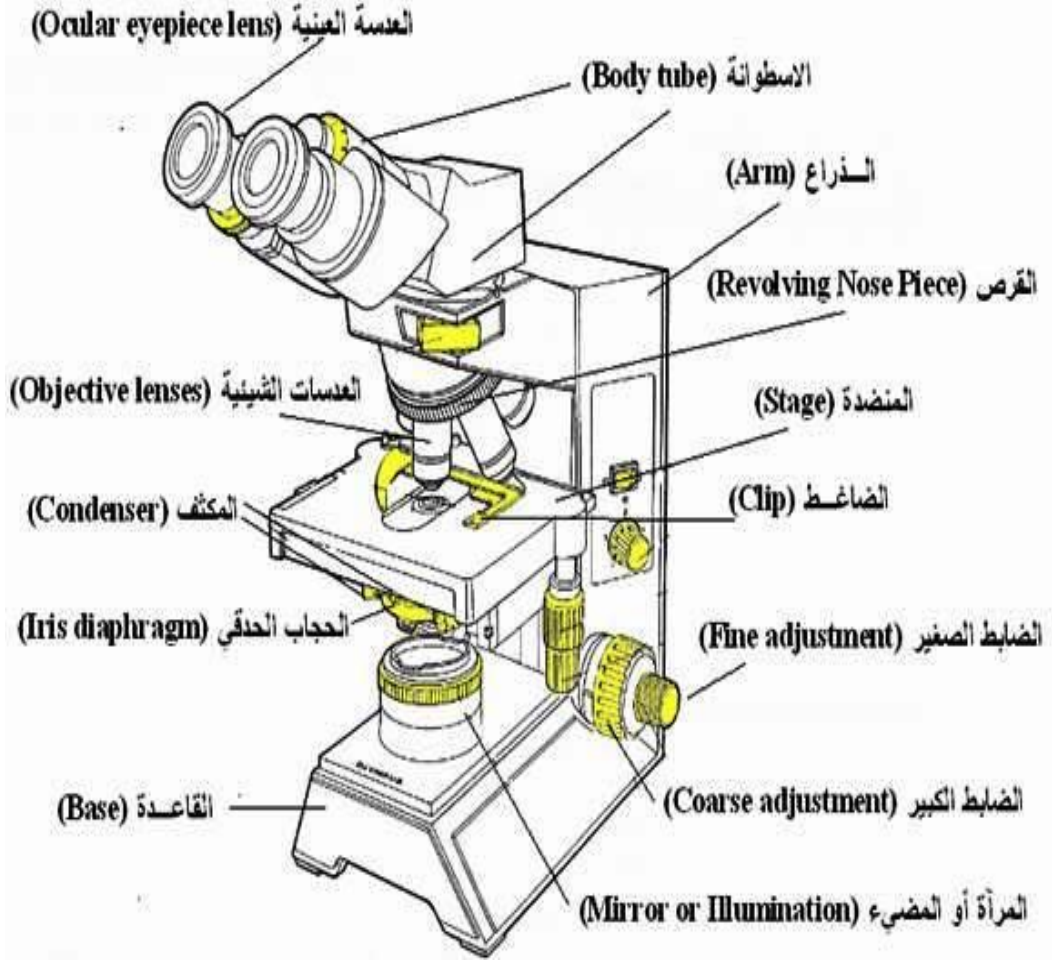

❖ تعليمات خاصة بالرسم:

الرسومات الجيدة للعينات تتطلب الاهتمام بالتفاصيل, وبالتالي عند الرسم في المعمل يجب الانتباه إلي ما يلي:-

- 1- ادرس ولاحظ العينات المعطاة لك بعناية بقدر الإمكان, ثم ارسم مباشرة ما تشاهده من العينات أو الشرائح المعطاه لك.
- 2- يجب مراعاة النسبة بين العينات المعطاة لك والرسم الذي تقوم برسمه لهذه العينات من حيث الحجم أو المساحة.
- 3- احرص علي الانتهاء من كل الرسومات في وقت المعمل.
- 4- رتب رسوماتك في دفتر المعمل بطريقة منسقة ومتسلسلة.
- 5- تجنب استخدام أقلام الرصاص اللينة أو أقلام الحبر.
- 6- اترك مساحة كافية حول الرسم لوضع البيانات علي أجزاء الرسم, وأشر بخط (سهم) إلي اجزاء العينة المختلفة, واكتب عند نهايتها اسم الجزء المشار إليه.

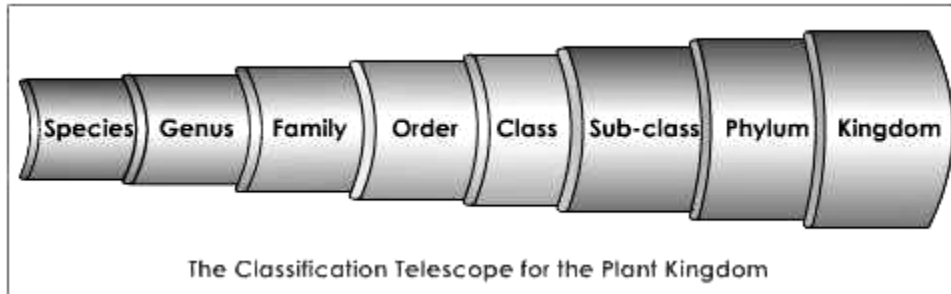

The classification telescope for the plant kingdom

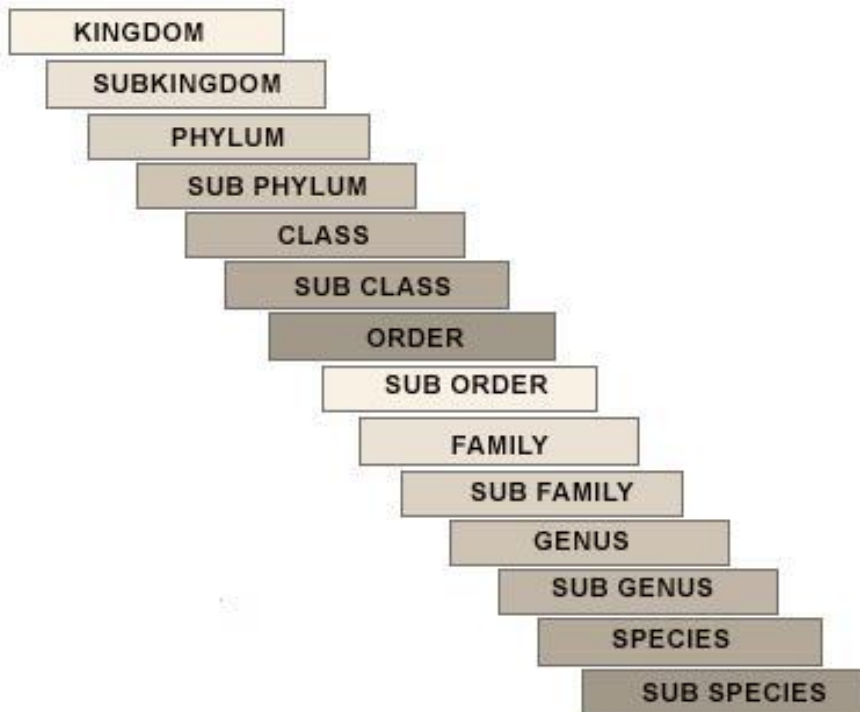

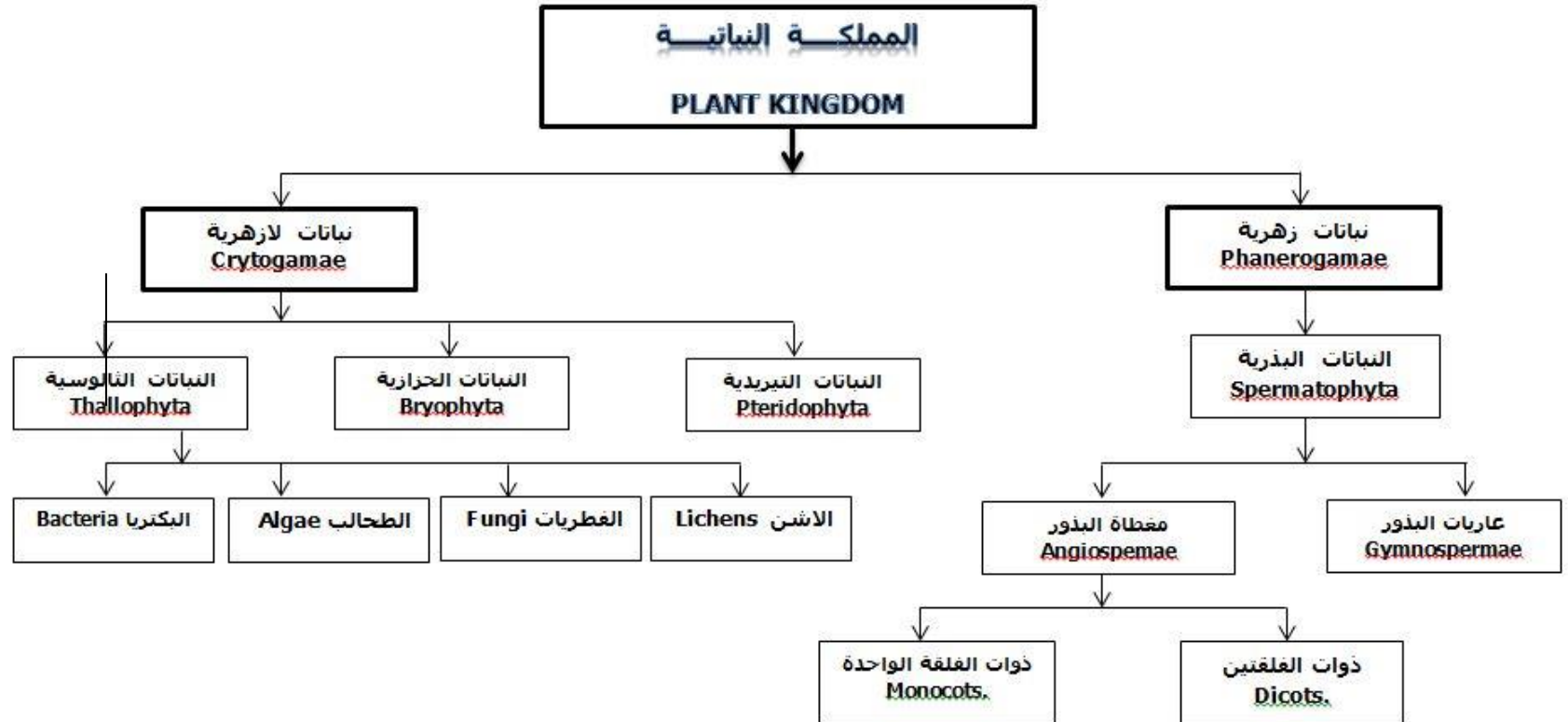

رسم تخطيطي يوضح تقسيم ايشلر للمملكة النباتية.

A- Thallophyta

1- Schizophyta (Bacteria)

Bacteria commonly known as microbes mostly possess a heterotrophic nutrition.

❖ Forms and groups of Bacteria

The main forms of Bacteria are:-

1- **Spherical Bacteria (Cocci):** Cocci are classified into several groups:

- **Micrococci:** single cell.
- **Diplococcic:** in pairs.
- **Streptococci:** in chains.
- **Staphylococci:** cocci in masses, shaped like a clusters of grapes.
- **Sarcinae:** cocci in cubes of eight.

2- **Cylindrical or rod-like Bacteria (Bacilli):** Bacilli are straight, cigarette-shaped. Some bacilli are curved. Bacilli may be divided into:-

- **Bacilli:** single cell.
- **Diplobacilli:** in pairs.
- **Streptobacilli:** in chains.

3- **Spiral bacteria (Helicodial):** They are shaped like a coiled wire spring some species are shaped much like a slightly twisted commas, these are grouped in the genus vibrio.

4- **Filamentous bacteria:** e.g. *Actinomyces*.

أ- تحت مملكة الثالوسيات

1- البكتيريا

❖ أشكال البكتيريا

1-بكتريا كروية: وتنقسم إلي:-

كروية وحيدة- كروية ثنائية- سبحية كروية- عنقودية- سارسينا (في مجموعات مكعبة).

2-بكتيريا عصوية: وتنقسم إلي:-

عصوية وحيدة- عصوية ثنائية- عصوية في سلسلة.

3-بكتيريا حلزونية: حلزونية الشكل او زاوية.

4-بكتيريا خيطية: خيوط متفرعة تتكاثر بالكونيدات كما في مجموعة البكتريا

الشعاعية.

Arrangements of Cocci

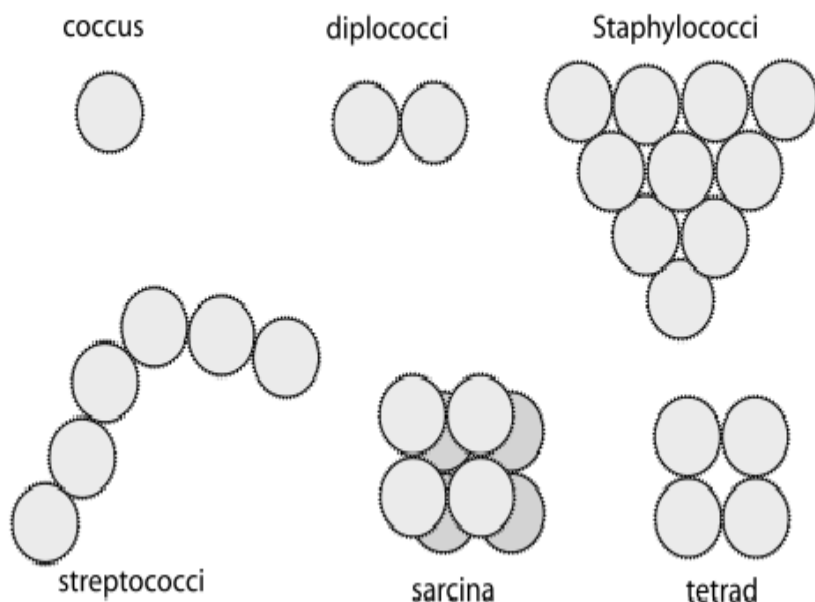

بكتيريا كروية

Arrangements of Bacilli

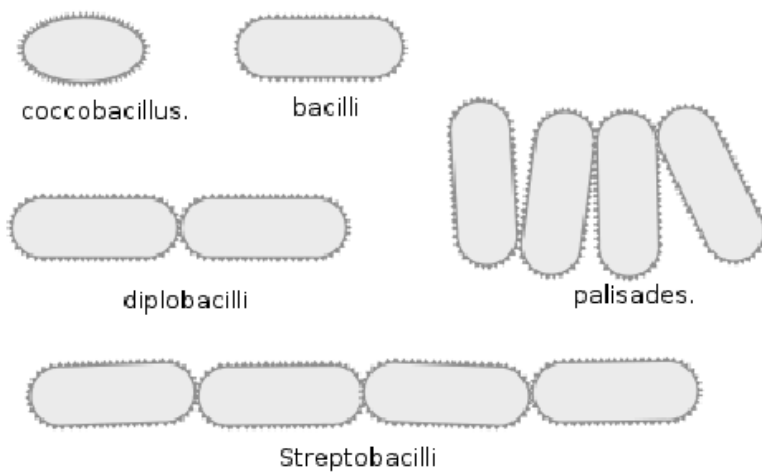

بكتيريا عصوية

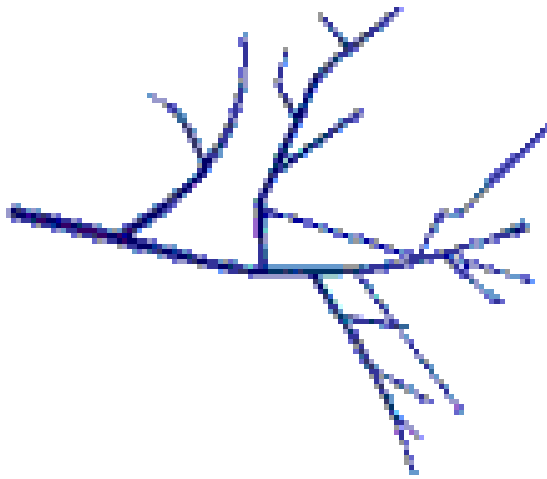

بكتيريا خيطية

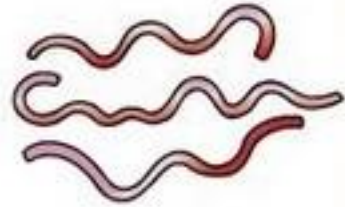

Borrelia



Treponema



Spirilla

بكتيريا حلزونية

Algae

2- Euglenophyta

Euglena:

Mount a drop of water containing *Euglena*, examine under the low and high power of the microscope. The unicellular organism appearing as an elongated, spindle shaped cell. The absence of a rigid cell wall results in a continuous change of the cell shape while it is moving. The eye spot or stigma appears as a red spot near the base of the gullet. There is also a contractile vacuole. Note also the nucleus, paramylon bodies (reserve food) distributed in the cytoplasm.

2- الطحالب اليوجلينية

اليوجلينا:

افحص خلايا طحلب اليوجلينا تحت المجهر. لاحظ السوط الذي يخرج من خلايا المرئ وعلي جانبيه البقعة العينية, واسفله فجوات قابضة. ولاحظ النواة والبلاستيدات الخضراء, والاجسام الباراميليونية المنغمسة في السيتوبلازم.

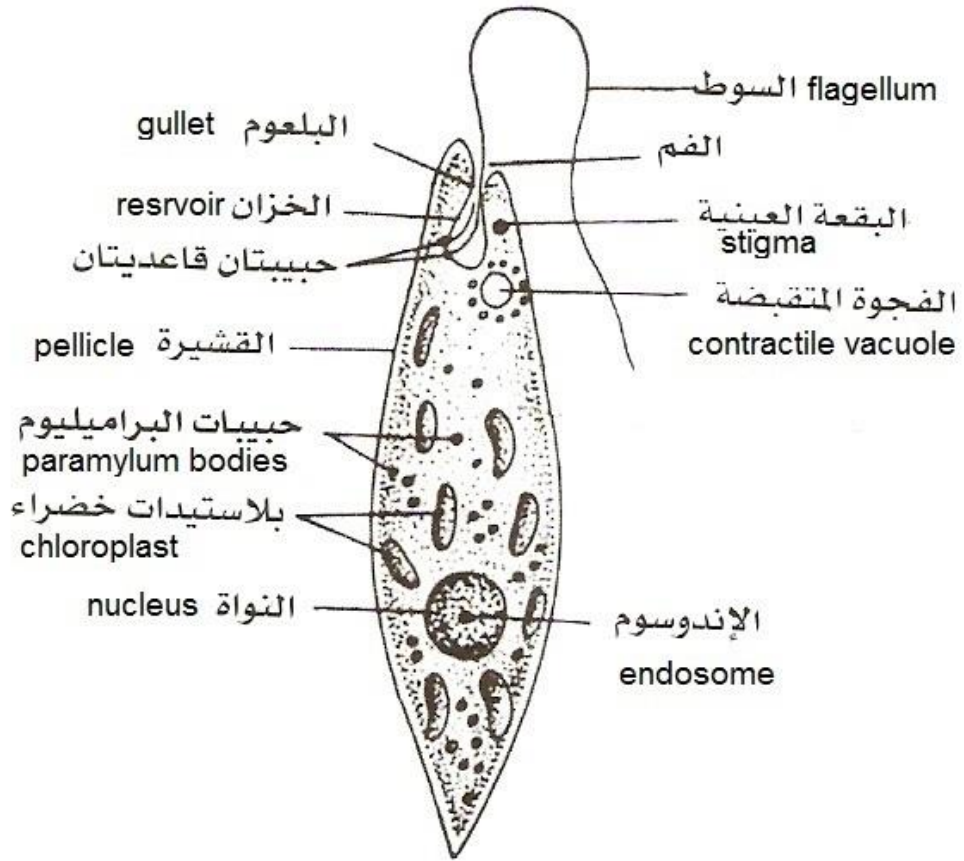

تركيب اليوجلينا

3- Cyanophyta

Nostoc:

Nostoc colonies occur in the form of spherical or cushion like masses. Within these masses are numerous coiled, interwoven, and unbranched filaments of *Nostoc*. The filament is composed of more or less rounded or barrel-shaped cells with constrictions between them. Intercalary heterocysts (these are specialized cells and arise by the metamorphosis of ordinary vegetative cells) are present. Vegetation reproduction takes place by the formation of hormogonia which are delimited by the heterocysts.

Oscillatoria :

The filaments are unbranched; the mucilaginous sheath around the filament is very thin. The cells are cylindrical and more broad than long, each cell has the usual detailed structure. The apex of the terminal cell may be produced into a cap-like calyptra.

3- الطحالب الخضراء المزرقة

النوستوك

افحص طحلب النوستوك ولاحظ ان شكل الطحلب كالسبحة, فهو عبارة عن شريط من خلايا كروية. لاحظ أيضا وجود خلايا متسعة برميلية الشكل تسمى حويصلات مغايرة, كما أن خلايا الطحلب تحتوي علي انوية محدودة.

الاوسيلاتوريا

افحص خيوط طحلب الاوسيلاتوريا تحت المجهر. لاحظ ان جدار الخلية تغلفه طبقة هلامية تبطن جدار الخلية البلازما الملونة وبداخلها تظهر الحبيبات الكروماتينية والفجوات الكاذبة والغازية.

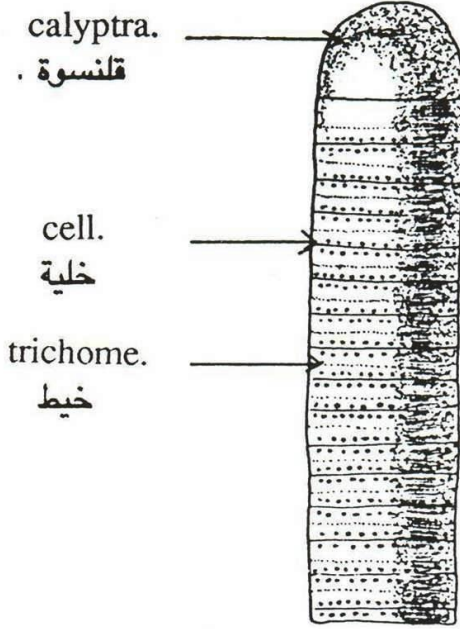

Oscillatoria sp.
أسيلا توريا

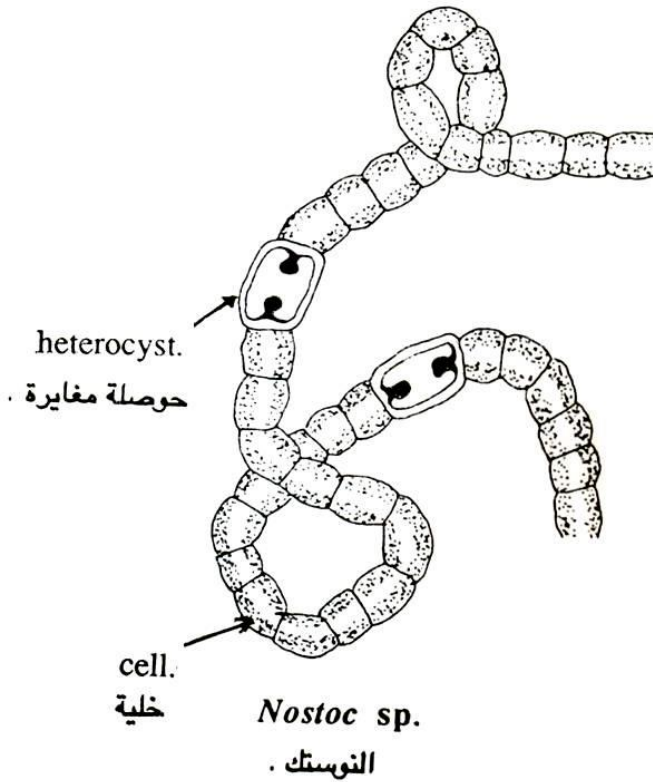

4- Chlorophyta

Chlamydomonas:

Examine the unicellular organism under the high power of the microscope. The general shape is usually oval, at the anterior end of the organism there are two flagella. Notice the two contractile vacuoles and the eye-spot at the anterior part of the cell. The cup shape chloroplast with one pyrenoid acting as a center around which starch is formed.

Pandorina:

Spherical solid conobium of 8 or 16 cells closely packed together and surrounded by mucous. The cells which have chlamydomonal structure are spindle in shape and each cell has two flagella attached to its broad end.

Volvox:

It is a hollow sphere colony with a large number of cells embedded in an external mucous material. The following types of cells can be distinguished:

- 1) Somatic cells.
- 2) Gonidia.
- 3) Sexual cells, they are antheridia (male cells) and oogonia (female cells).

4- الطحالب الخضراء

الكلاميدوموناس

خذ عينة من مياه البرك علي شريحة نظيفة بواسطة انبوبة شعرية ثم ضع غطاء الشريحة علي نقطة الماء, وافحص بالعدسة الكبرى, وتحقق من وجود صلب الكلاميدوموناس. الطحلب وحيد الخلية كمثري الشكل والطرف المدبب به نقطة حمراء عينية ويخرج من هذا الطرف هذان تساعدان الطحلب علي الاندفاع في الماء بحركة لولبية تشبه البريمة. لاحظ وجود بلاستيده فنجانية الشكل في الطرف المتسع للخلية. أضف للتحضير نقطة من محلول اليود تجد ان المركز النشوي الموجود في قاع البلاستيده يتلون باللون الازرق مما يدل علي أن هذا الجسم له علاقة بتكوين النشا.

الباندورينا

لاحظ ان الطحلب عبارة عن مستعمرة طحلبية مصمتة تتكون من ثمانية أو ستة عشر خلية متشابهة, كل واحدة منها شبيهة بالكلاميدوموناس مرتبة في مستعمرة بشكل خاص حيث ان سطح طرف الخلية العريض يتجه إلي الخارج. لاحظ أيضا انه لا يوجد تمييز بين خلايا الطحلب.

الفولفوكس

افحص الشرائح الجاهزة لطحلب الفولفوكس ولاحظ أن الطحلب عبارة عن مستعمرة كروية جوفاء متكونة من عدد كبير من الخلايا تتصل ببعضها بواسطة خيوط سيتوبلازمية وتتميز الخلايا في المستعمرة إلي أربعة أنواع هي:-

- (1) خلايا خضرية هدية.
 - (2) خلايا جونيديه.
 - (3) خلايا تكاثريه: وهي عبارة عن الانثريدات (خلايا بها امشاج ذكرية) والاووجونات (خلايا بها البويضات الانثوية).
- لاحظ وجود مستعمرة بنوية في تجويف المستعمرة الاصلية.

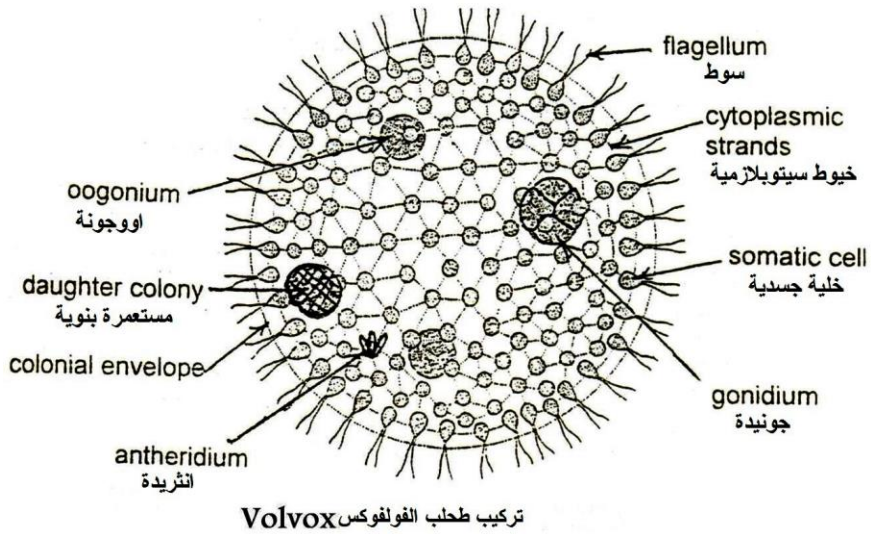
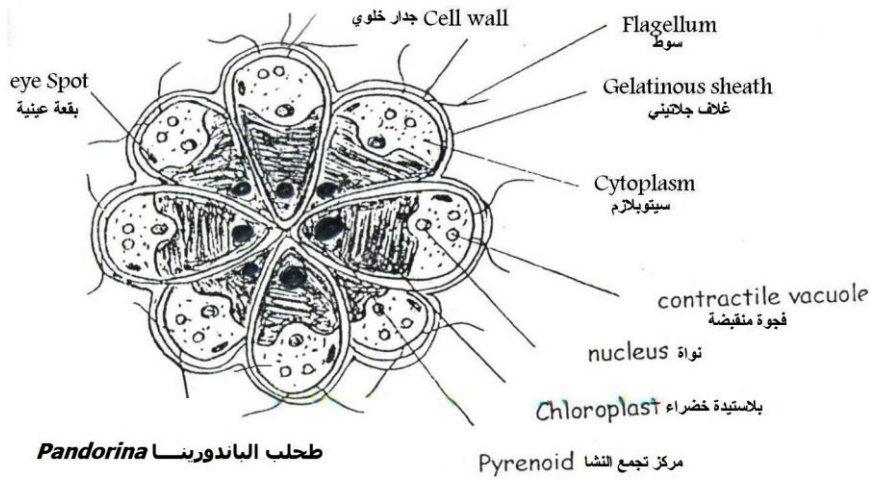
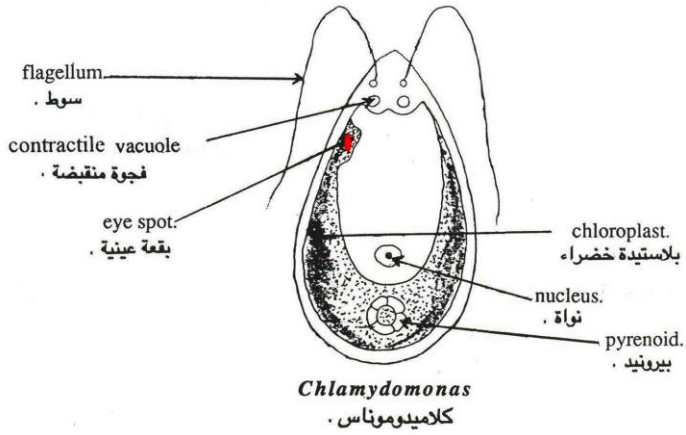

Spirogyra:

Unbranched filament, consisting of a row of similar cells. The spiral arranged chloroplasts with many pyrenoids. The nucleus is central and suspended by cytoplasmic strands.

Sexual reproduction:

- 1) Scalariform conjugation.
- 2) Lateral conjugation.

الاسبيروجيرا

خذ عينة من الريم الاخضر وافحصها ميكروسكوبيا. لاحظ وجود خيوط عديدة غير متفرعة والخيوط الواحد مكون من عدة خلايا مستطيلة متلاصقة طرفا إلى طرف. وفي كل خلية بلاستيدة خضراء او أكثر. والبلاستيدة عبارة عن شريط ملتف كالحلزون ذو حافة متموجه. ويوجد بالخلية نواة واحدة تكون عادة معلقة في مركز الخلية بواسطة خيوط سيتوبلازمية.

ابحث عن خيطين في حالة تزواج سلمي ولاحظ ان محتويات أحد الخيطين الذي يعتبر مذكرا تمر خلال انابيب التزاوج الي الخيط الاخر الذي يعتبر مؤنثا, وعليه فالخيوط الاخر يكون مملؤا بالزيجوتات.

Cell wall جدار خلوي

Nucleus نواة

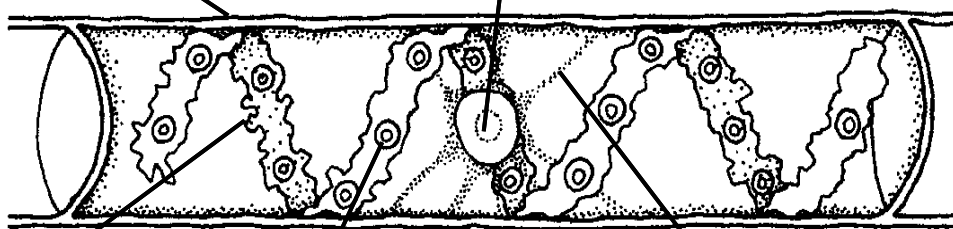

Spiral shape chloroplast
بلاستيدة حلزونية الشكل

Pyrenoid
مركز تجمع النشا

Cytoplasmic strands خيوط

سيتوبلازمية

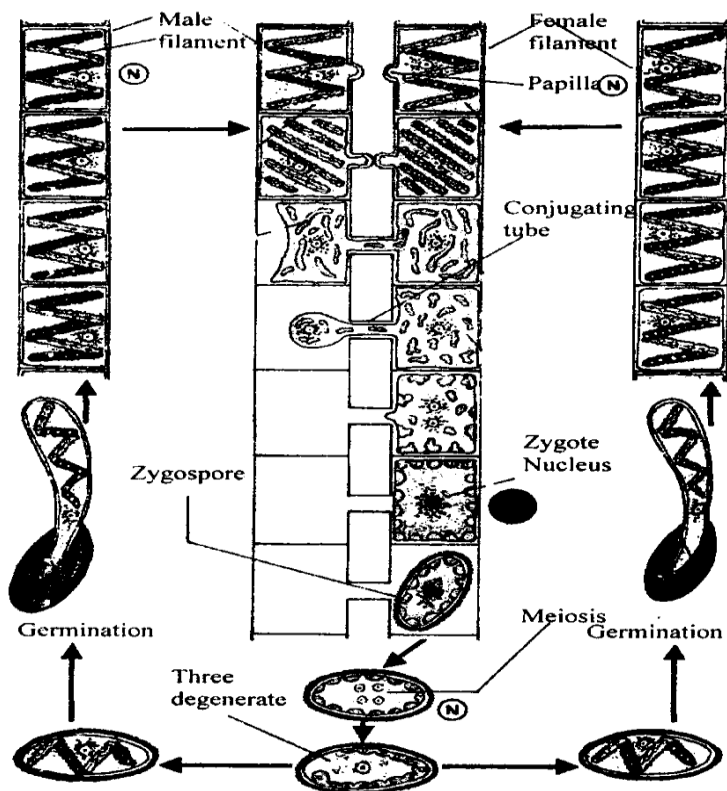

الاقتران السلمي في طحلب الاسبيروجيرا

5- Chrysophyta

Vaucheria:

The filament consists of tubular coenocytic, non-septate branched filaments. The coenocyte contains numerous small disc shaped chloroplasts and nuclei embedded in the cytoplasm. The reserve material is mainly oil which appears as droplets.

Examine the oogonium (female). It is cut from the rest of the coenocyte by a wall, it contains one egg. The antheridium is an elongated curved tube, separated from coenocyte by transvers septum.

Diatoms:

Examine and draw the material provided. Notice the symmetrical shape of the cells. Diatoms are unicellular organisms with radial or bilateral symmetry. In the side (or girdle) view you can detected one or the two valves, the outer (epitheca) and the inner (hypotheca), the view where the valves meet, is called the girdle.

Notice the silica protrusions laid on the cell wall giving it a very characteristic feature. In the valve view, note the raphe which is a narrow slit connecting two polar nodules with a central one.

5- الطحالب الخضراء المصفرة

الفوشيريا

يتكون ثالوس هذا الطحلب من خيوط متفرعة عبارة عن مدمج خلوي. لاحظ أن الطحلب وحيد المسكن, فالاووجونة كروية وبها بيضة واحدة ولها بروز او منقار أما الانثريدة فتنشأ بجوار الاووجونه وهي اسطوانية مقوسة, يفصل كل من الاووجونة والانثريدة بجدار مستعرض عن بقية الخيط.

الدياتومات

افحص الشرائح الميكروسكوبية المجهزة او عينة مياه ولاحظ ان غالبية الدياتومات توجد منفردة. ومما تجدر الاشارة اليه:

- 1) المقدار الكبير من السيليكا الذي يتخلل الجدار الخلوي.
- 2) ان الجدار الخلوي يتكون من نصفين يسمي كل منهما مصراع وهما يتراكبان معا ويسمي المصراع الخارجي بالغمد الفوقي ويسمي المصراع الداخلي بالغمد التحتي.
- 3) في الدياتومات المستطيلة يوجد شق طولي يسمي الرفاية تنتظم عليه عقدتين قطبيتين وعقدة وسطية.

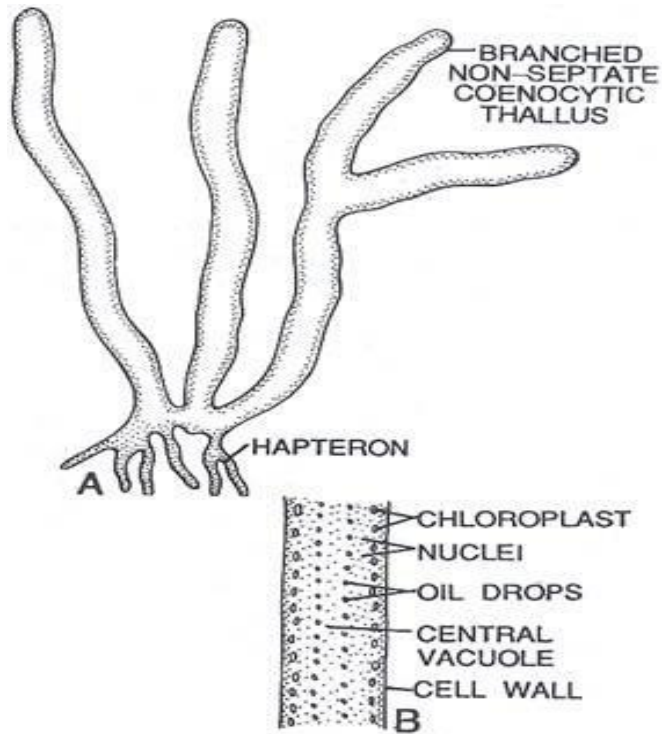

Vaucheria sp. Vegetative structure; A, a complete thallus; B, a part of thallus (enlarged).

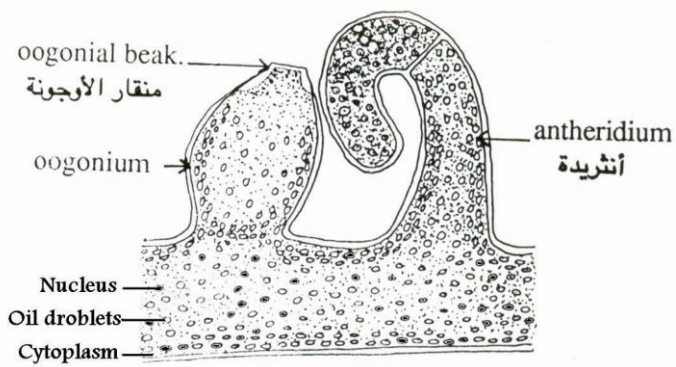

Vaucheria sp. sexual reproduction.

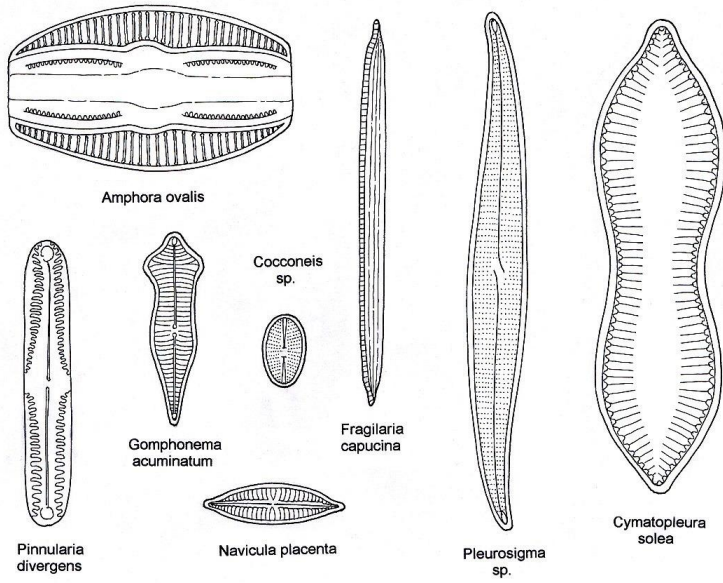
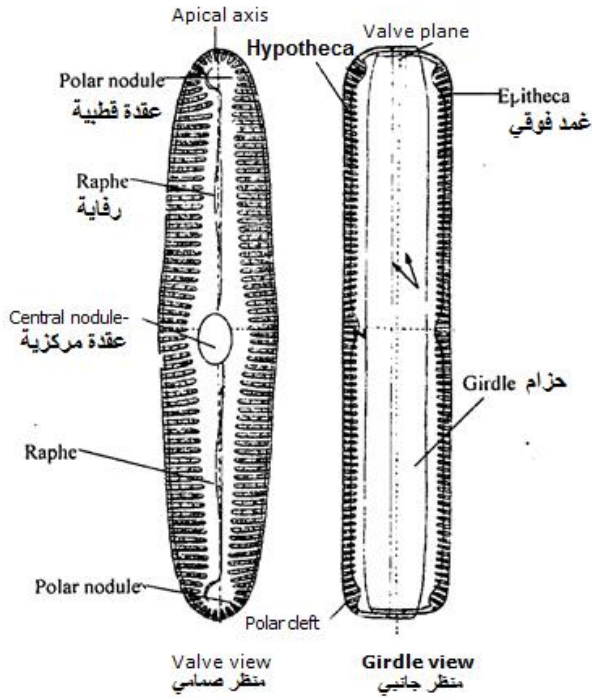

A selection of diatoms.

6- Phaeophyta

Fucus:

The thallus is a dichotomously branched ribbon shaped structure presenting leathery appearance and narrowed below into a short stalk-like stipe which ends in the holdfast. Each lobe of the thallus has a distinct midrib, when the plants become fertile, cavities or conceptacles containing sex organs appear towards the tips of the branches. Some species possess air bladders.

The thallus is formed anatomically of assimilating layer, storage layer and the medulla.

Examine the prepared sections of male and female conceptacles.

Male conceptacle:

It consists essentially of an outer multilayered wall. The inner surface of this wall produces hairs. Some of which project to the outside through the ostiols. These hairs are called paraphysis which are numerous branched and carry the antheridia on their lateral branches.

Female conceptacle:

The macrosporangia (oogonia) are carried very short stalks arising directly from the conceptacles wall. These macrosporangia are intermixed with multicellular unbranched paraphysis. Each macrosporangium (oogonium) contains eight eggs.

6- الطحالب البنية

الفيوكس

ارسم الشكل الخارجي لثالوس الفيوكس مبينا أن الثالوس المتورق يتفرع تفرعا ثنائي الشعب ولاحظ ان النبات يثبت نفسه في الصخور بواسطة ماسك Holdfast وأما الجزء السفلي غير المتفرع فيسمى بالعنق.

افحص القطاعات المجهزة للحوافظ الجنسية لمشاهدة الاعضاء الجنسية التي توجد بداخلها او وجوده معنقة بكل منها ثماني بويضات ويوجد بين الاووجونات خيوط عقيمة غير متفرعة. اما الحافظة الجنسية المذكورة فتحتوي علي عدد كبير من الخيوط العقيمة المتفرعة تنتظم عليها الانثريدات كفروع جانبية. وتتصل كل حافظة جنسية بالخارج عن طريق ثقب صغير علي السطح يسمى الفوهة.

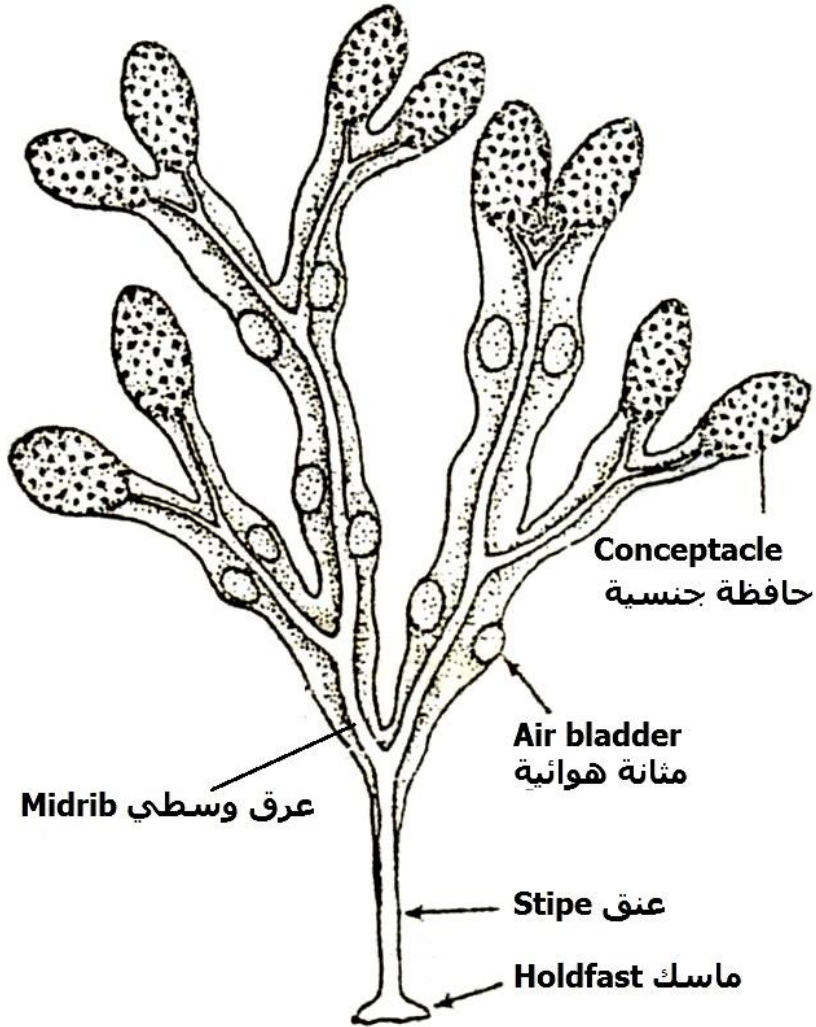

Fucus
الشكل الخارجي للفوكس

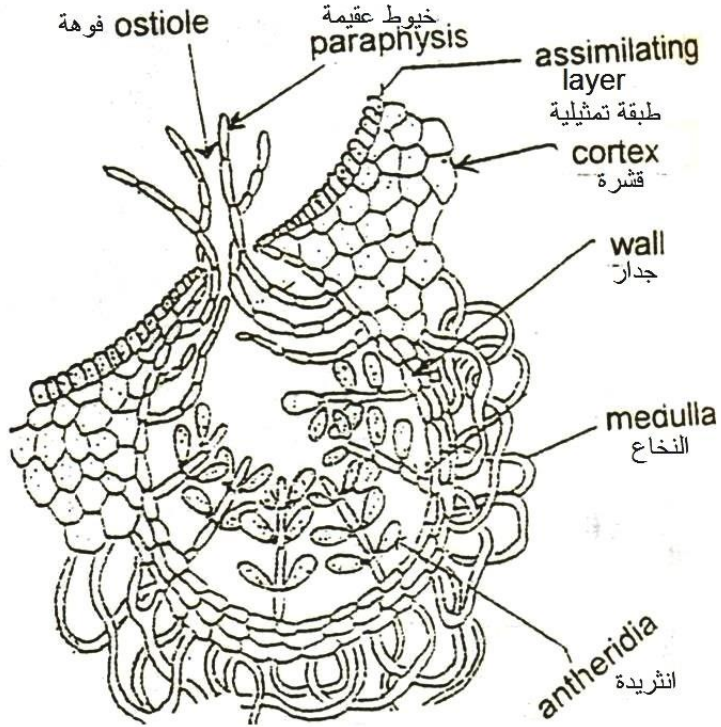

Male conceptacle in *Fucus*
حافطة جنسية مذكرة في الفيكوس

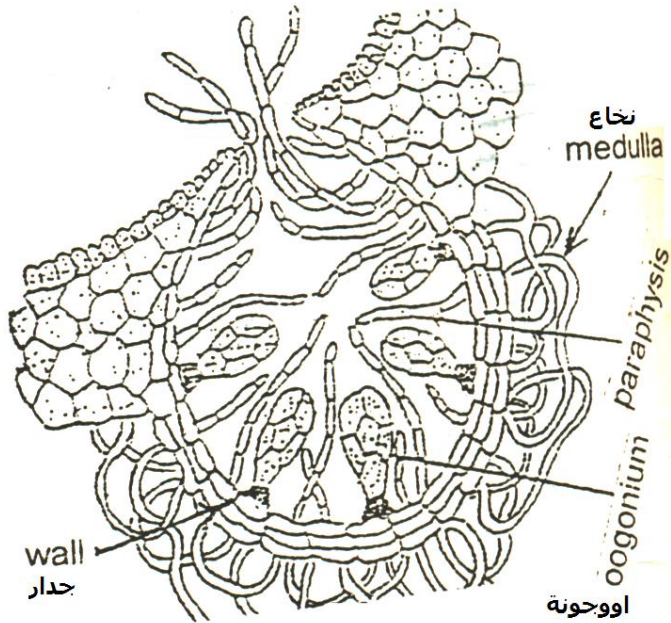

Female conceptacle of *Fucus*
حافطة جنسية مؤنثة في الفيكوس

B- Eumycophyta

1) Calss:Phycomycetes (algal fungi)

Rhizopus (black mould)

Examine the growth of *Rhizopus* (Black mould) on the moist bread with a lens.

Make out the creeping hyphae stolon and the vertical branches with mature and immature sporangia.

Mount a small piece of young *Rhizopus* in water, examine with the microscope and sketch a portion of it showing the cell wall and the protoplasm containing numerous vacuoles which become smaller towards the growing tip of the hyphae.

Draw young sporangia, some showing sporangiospores columella and some in earlier stages of development as seen under the high power.

Sexual reproduction:

Examine and draw the demonstration slide showing conjugation hyphae and the successive stages in zygospore. (Thick-walled and dark colored formation).

ب- الفطريات الحقيقية

1- الفطريات الطحلبية

عفن الخبز الاسود

هذا الفطر يسبب تعفنا للخبز والفاكهة . خذ قطعة صغيرة من الميسيليوم علي شريحة وحملها في قطرة من الماء او الجلسرين ثم افحصها ميكروسكوبيا وارسم الفطر وبين الاجزاء التالية:-

1- الهيفا المدادة الرئد (stolon) تمتد فوق سطح الوسط الغذائي او المادة العضوية (قطعة خبز).

2- أشباه الجذور: تقوم بتثبيت الفطر في الوسط الغذائي وامتصاص الغذاء.

3- حوامل الحواظ الجرثومية : وتنبت مقابل أشباه الجذور.

4- الحافظة الجرثومية: وبها عدد كبير من الجراثيم الحافظة متجمعة فوق العويميد.

5- عند انتشار الجراثيم يتمزق جدار الحافظة الجرثومية ولا يتبقي منه الا حلقة بسيطة تسمى الباقة (collar).

ادرس مراحل التكاثر الجنسي في شريحة مجهزة ولاحظ شكل وتركيب اللاقحة الجرثومية.

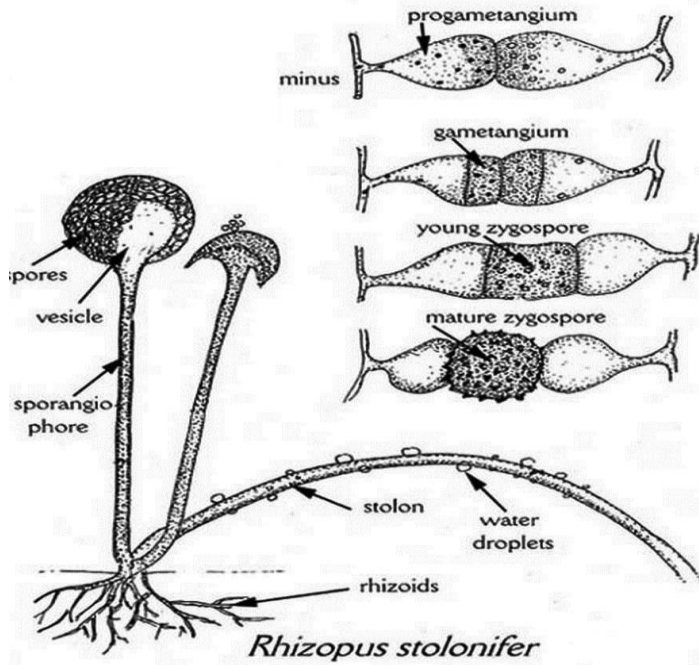
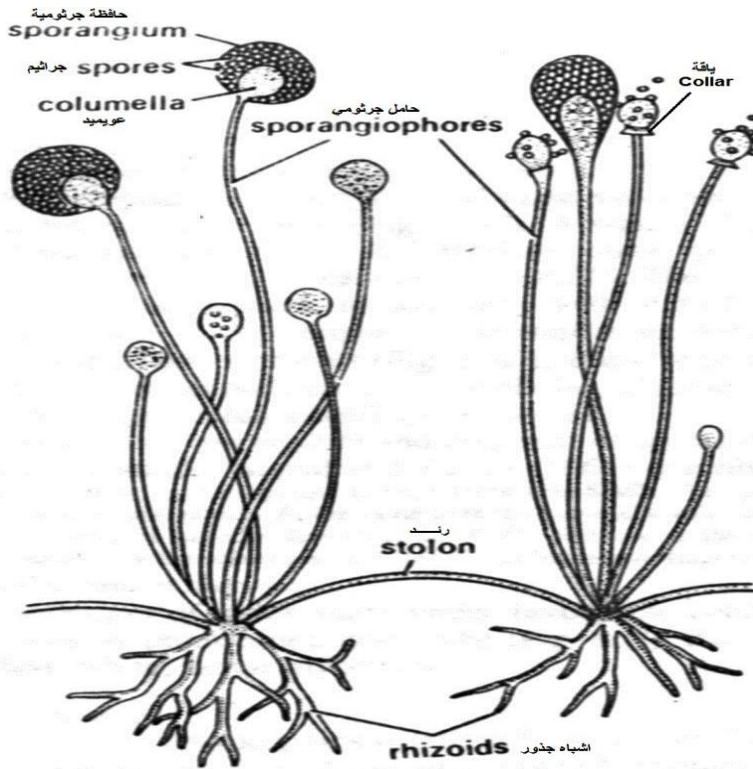

2) Class: Ascomycetes

Saccharomyces (Yeast):

Examine a drop of the material provided and notice that the yeast is a unicellular organism, the cell being more or less ovoid. There is a distinct cell wall, and the cytoplasm surrounds a big nucleus.

The nucleus consists of vacuole traversed by chromatin filaments and there is a small nucleolus lying adjacent to but distinct from vacuole.

In the cytoplasm several inclusions are embedded as mitochondria, reflective volutin granules, Oil droplets and glycogen particles.

Observed that a new bud can separate from the original cell to form a new cell, when rapid budding is taking place, small chains or clusters of buds may be seen.

2- الفطريات الزقية

الخميرة

خذ نقطة من معلق الخميرة في الماء المصبوغ بأزرق الميثيلين علي شريحة نظيفة, ضع غطاء الشريحة بإحتراس وافحص التحضيري بالعدسة الكبرى.
 خلايا الخميرة كروية الشكل او بيضية الشكل وبكل منها جهاز نووي, لاحظ التكاثر الخضري بالتبرعم.

Aspergillus (Black mold):

The mycelium consists of much branched and septate hyphae with multinucleate cells, from the mycelium arise non-septate conidiophores, the free end of the conidiophore swells up into a vesicle, numerous phialides or sterigmata, are budded out from the vesicle and cover its entire surface, the sterigmata produce conidia chains, the youngest conidia being at the base of the chain (acropetally succession).

Penicillium (Green mold):

Examine the growth of *Penicillium* on agar under the low power of the microscope. Mount a small piece in water. Examine and sketch a portion of showing, the cell wall and the protoplasm. Note the presence of transverse walls (septa) (i.e. septate and branched multinucleate filaments).

Peziza:

Examine a vertical section in the ascocarp or apothecium and notice that asci are vertically arranged, each containing eight ascospores. Below the hymenium we find the sub-hymenium layer which composed of compact hyphae. The hymenium and sub-

hymenium layers are both surrounded with a wall called peridium composed of interwoven hyphae.

اسبرجيلس (العفن الاسود):

جهاز شريحة لهذا الفطر النامي علي البيئات الصناعية داخل أطباق بتري ثم افحص التحضير بالعدسة الكبرى للميكروسكوب. لاحظ ان الحامل الكونيدي غير مقسم, مع ان الغزل الفطري نفسه مقسم وينتهي الطرف الحر للحامل الكونيدي بانتفاخ عليه عدة ذنبيات يحمل كل منها سلسلة من الكونيدات.

بنسيليوم (العفن الاخضر):

لاحظ الاعراض علي ثمرة البرتقال المصابة بالعفن الاخضر, حمل جزء من الفطر في الماء او الجليسيرين, وافحص العينة بالعدسة الكبرى للميكروسكوب ثم ارسم الحوامل الكونيدية للفطر. تحقق من وجود حواجز عرضية في الحامل الكونيدي وأنه ينتهي بتفرع يشبه المقشه, واطراف الفروع تسمى الذنبيات وهي بدورها تحمل الكونيدات في سلاسل.

البيريزا:

ارسم الجسم الزقي الكاسي الشكل للفطر الذي ينمو علي روث البهائم. ادرس القطاع العمودي للكأس الزقي الذي يتكون جداره من خلايا برانشيمية كاذبة ويوجد بداخله الطبقة تحت الخصيبة التي تتكون من خيوط متشابكة ويوجد بأعلي هذه الطبقة الاخيرة الطبقة الخصيبة التي تحتوي علي زقاق تتخللها خيوط عقيمة ويحتوي كل زق علي ثمانية جراثيم مرتبة في صف واحد.

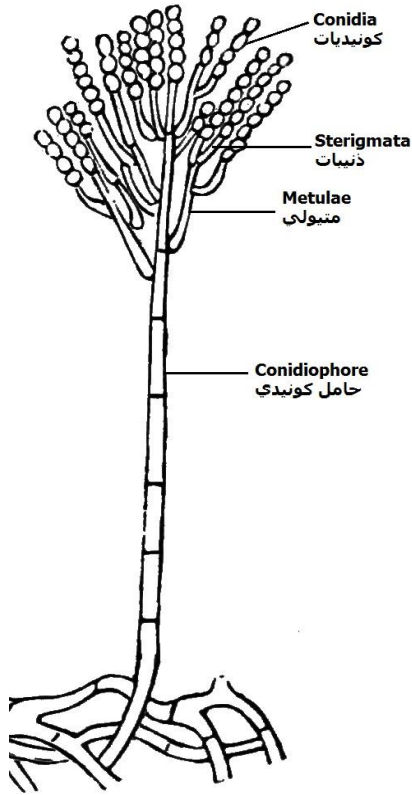

Penicillium sp. فطر البنسيليوم

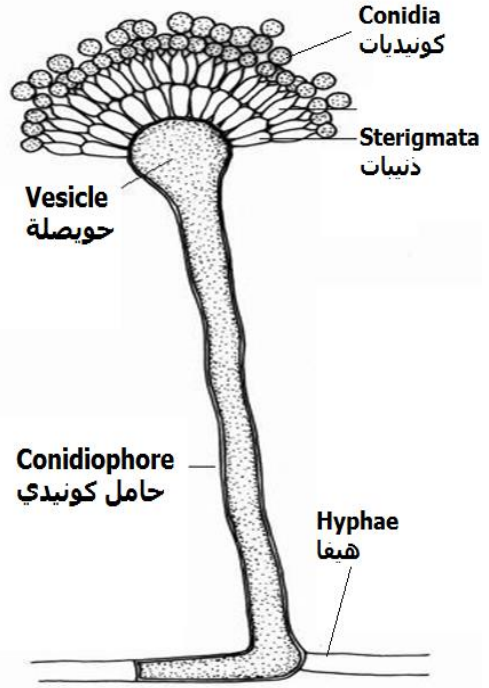

Aspergillus sp. فطر الاسبرجيليس

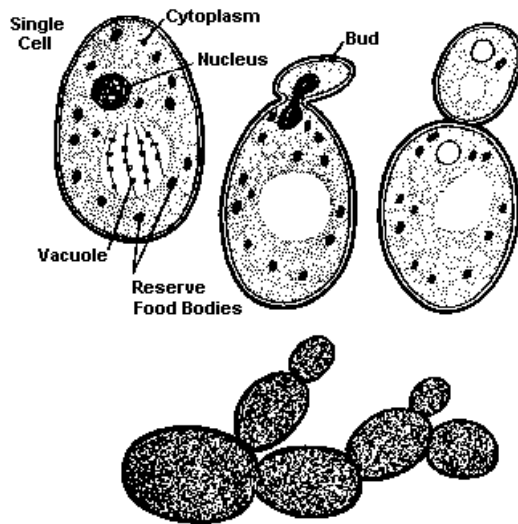

Saccharomyces (Yeast) فطر الخميرة

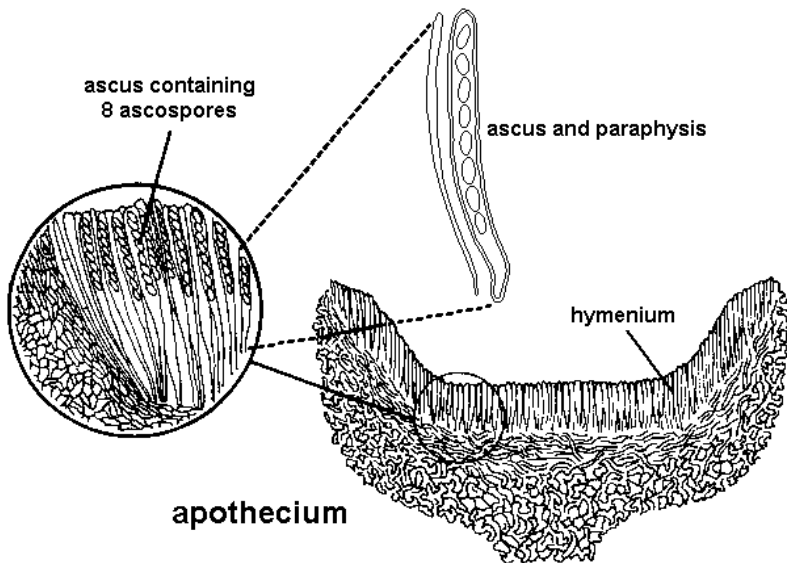
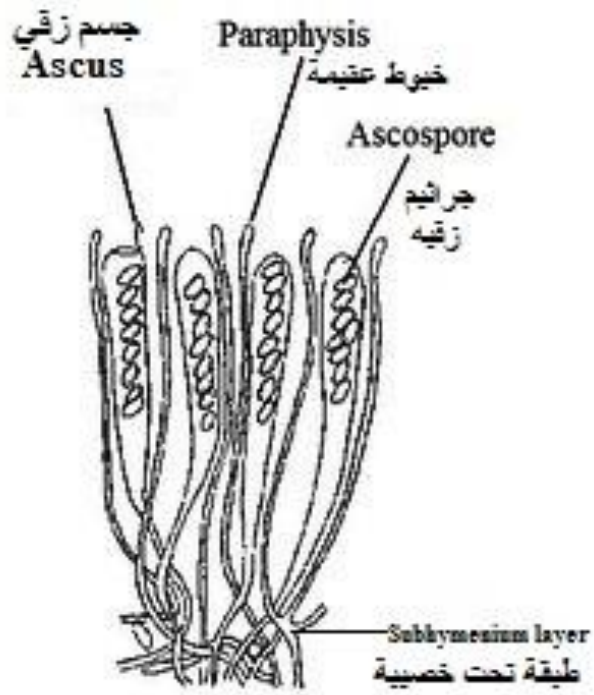

Peziza sp. البيزيزا

3) Class: Basidiomycetes

Puccinia graminis (wheat rust):

It causes the black or stem rust of wheat, oat, barley and several grasses. It is a parasitic member of basidiomycetes which completes its life cycle on two hosts and produces several kinds of spores.

a) Uredial stage (red rust stage):

Examine the surface of stem or leaf segments of wheat carrying uredia. Uredosori have a red or orange color due to the abundance of uredospores. Study a cross section of infected wheat stem and note that the surface covered with huge numbers of oval shaped uredospores borne on the terminal ends of stalks (hyphae), each spore contain two nuclei, and is composed of one cell with an outer spiny thick wall.

b) Telial stage (black rust stage):

Examine the teleutospores which are elongated, black instead of red and are two-celled with an outer smooth thick wall. Each cell contains one nucleus.

c) Aecidial stage:

Note also the several large cup-shaped aecia located on the lower surface of Berberis leaf. From the bottom of each aecium arises a closely packed parallel chain of bi-nucleate, sub-globose, light orange yellow aecidiospores. Note that each aecium is surrounded by a protective layer of compact hyphae known as the peridium.

Agaricus (Mushroom):

It is a saprophytic fungus, note that the basidiocarp (fruit body) consists of a stalk and an umbrella shaped cap. An annulus may be found as membranous ring around the upper part of the stalk.

Examine a vertical section through the gills; note that each gill is composed of three layers:

- a- Outer surface layer (hymenium) composed of basidia borne each 4 basidiospores and paraphyses.
- b- The second layer is found as a compact zone of hyphae forming the sub-hymenium layer.
- c- A central zone composed of loose hyphae known as trama.

3- الفطريات البازيدية

باكسنيا جرامينس (صدأ القمح)

يعيش الفطر متطفلا ويتم دورة حياته علي عائلين مختلفين هما: نبات نجيلي (القمح) ونبات البيربري. افحص نبات القمح المصاب بصدأ الساق الاسود ولاحظ وجود نوعين من البثرات:

(ا) بثرات مستطيلة برتقالية اللون تعرف بالبثرات اليوريدية. خذ قطاعا عرضيا مارا بالبثرة اليوريدية ولاحظ وجود الجراثيم اليوريدية وهي جراثيم معنقة ذات شكل بيضي, ولها جدار سميك نوعا ويحمل عددا من البروزات الشوكية ومكونة من خلية واحدة بها نواتان ولها عدد من ثقوب الانبات في الجزء الوسطي.

(ب) بثرات مستطيلة سوداء اللون تعرف بالبثرات التلثية, خذ قطاعا عرضيا مارا بالبثرة التلثية ولاحظ وجود الجراثيم التلثية وهي جراثيم معنقة ذات شكل مغزلي ولها جدار سميك

املس, وهي مكونة من خليتين بكل منها نواة ثنائية المجموعة الكروموسومية ولكل منها ثقب إنبات.

(ج) البثرات الأسيديّة: تصل علي السطح السفلي لورقة نبات البيربري وهي تراكيب كأسية الشكل محاطه بجدار عقيم يسمى البريديام ويوجد عند قاعدة الكأس صفوف من الخلايا المستطيلة ينبثق من كل منها سلسلة من الجراثيم الأسيديّة والجرثومة الأسيديّة لها جدار رقيق وهي وحيدة الخلية وثنائية الانوية.

عيش الغراب

افحص الجسم الثمري اي الحامل الجرثومي ملاحظا انه يتكون من عنق وقلنسوة تشبه المظله وتحمل القلنسوة علي سطحها السفلي صفائح رقيقة تسمى الخياشيم, لاحظ وجود جزء من نسيج متبقي حول الطرف العلوي للعنق يعرف بالطوق.

خذ قطاعا في القلنسوة والخياشيم لدراسة التركيب الداخلي للصفحة الخيشومية وافحصه ميكروسكوبيا ولاحظ انها تتركب من:-

- 1- التراما: تتكون من خيوط فطرية مفككة في مركز الخيشوم.
- 2- الطبقة تحت الخشبية: تقع خارج التراما من كل من الجانبين وهي تتكون من طبقة من الخلايا والخيوط الفطرية المتماسكة.
- 3- الطبقة الخشبية: أقصى الطبقات الخارجية وهي مكونة من عدد كبير من البازيدات والهيئات العقيمة, يحمل كل بازيد أربع جراثيم بازيدية علي اربعة اعناق قصيرة هي الزنبات.

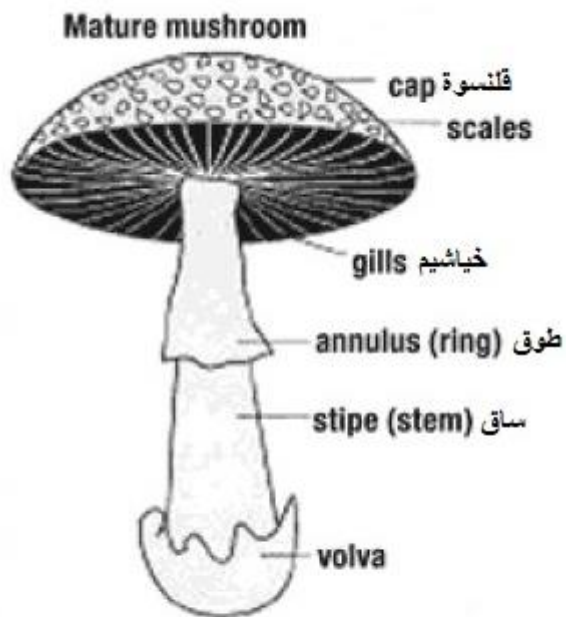

Agaricus عيش الغراب

Basidium

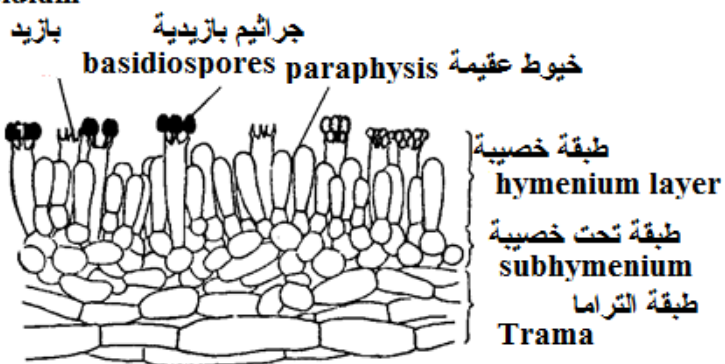

T.S. in gills of *Agaricus*

قطاع في الخياشيم لفطر عيش الغراب

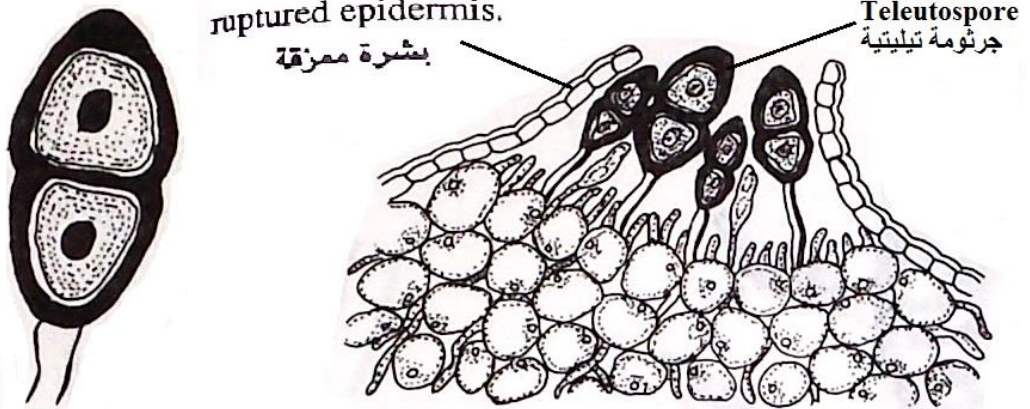
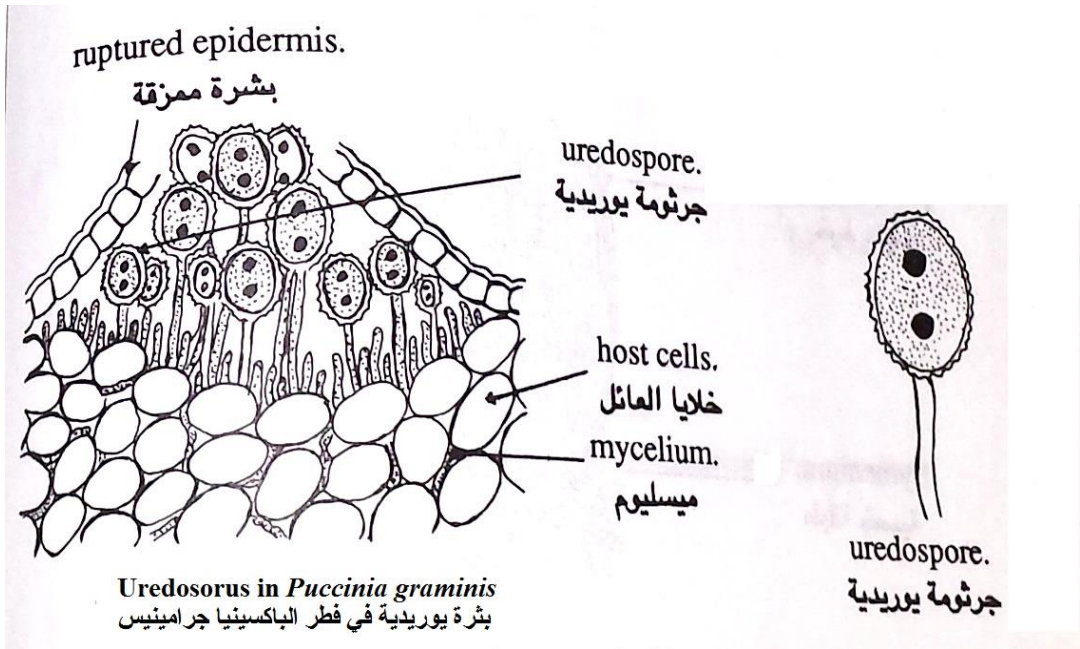

Puccinia sp.T.S wheat leaf through teleutasorus and magified teleutospore

باكسينيا قطاع عرضي في بثرة تيليتية
وجرثومة تيليتية مكبرة

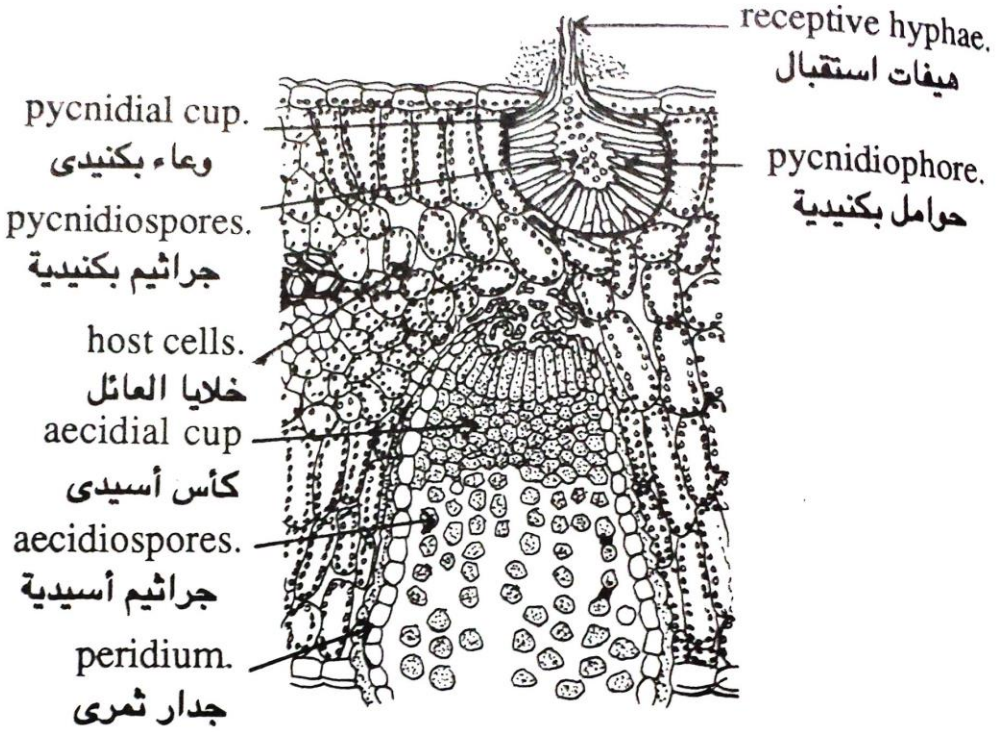

Puccinia sp. T.S Berberis
leaf showing pycnidial and aecidial cups.

باكسينيا . كؤوس الأسدية
والأوعية البكنية بداخل ورقة نبات البيربيرس

Lichens

The lichens are composite plants made up of an alga and fungus, the two being very intimately associated together. The thallus mainly consists of fungus, the alga being held between the fungus hyphae.

Note the growth habit of lichens, which may be either **crustose**, **foliose** (leaf-like) and **fruticose** (much branched and shrub-like).

Study a vertical section through a foliose thallus and notice the following zones:

- a) Upper cortex: consists of compact fungal hyphae.
- b) Algal layer (gonidial layer): composed of loose hyphae surrounding the algal cells.
- c) Medulla: composed of very loosely interwoven hyphae.
- d) Lower cortex: composed of compact hyphae. The outer surface of this zone gives rise to rhizoid-like hyphae called rhizoid for fixation.

الأشن

الصفة المميزة للاشن هي انها تتكون من كائنين مميزين مختلفين هما فطر وطحلب. لاحظ ان الاشن تتشكل الي ثلاثة انواع هي:-

1- **اشن قشرية:** وهي تظهر علي سطح الصخور والأحجار في صورة قشور رقيقة.

2- **أشن ورقية:** وهي توجد عالقة علي قلف بعض الاشجار كالموالح والتين علي هيئة صفائح عريضة مفلطحة تشبه الوراق.

3- **أشن شجيرية:** وتتميز بأنها متفرعة كشجيرة صغيرة وهي أما تنمو علي سطح التربة او عالقة بأغصان الاشجار.

افحص قطاعا في احد انواع الاشن ولاحظ الطبقات التالية:-

1- **القشرة العليا:** وهي تتكون من هيفات الفطر المتماسكة.

2- **الطبقة الطحلبية:** وهي تتكون من هيفات غير متماسكة وتختلط معها خلايا الطحلب.

3- **طبقة النخاع:** وتتكون من هيفات غير متماسكة.

4- **القشرة السفلي:** وتشبه القشرة العليا.

LICHEN TYPES:-

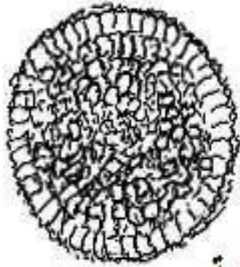

Crustose اشن قشرية

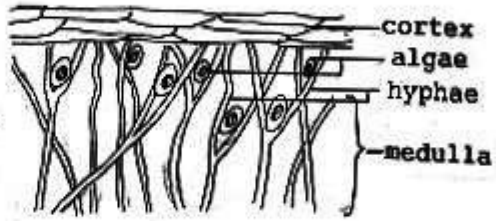

Transverse Section



Foliose اشن ورقية

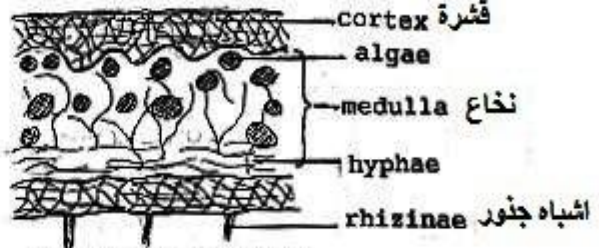

Transverse Section

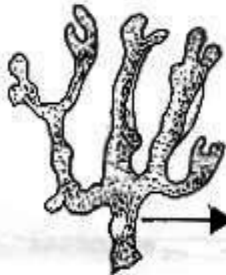

Fruticose اشن شجيرية



T.S.

ALGAE TYPES.

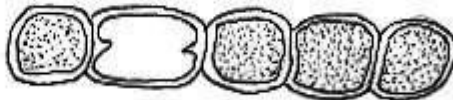

Nostoc



Trebouxia



Trentepohlia

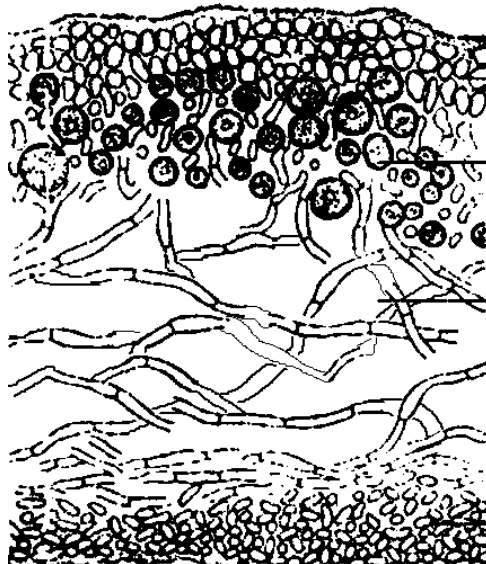

قشرة عليا
Upper cortex

upper algal layer

طبقة طحلبية

Medulla

نخاع

قشرة سفلى
Lower cortex

C-Bryophyta

1- Hepaticae (liverworts)

Riccia:

Gametophyte of *Riccia* is the domination plant green, thalloid and rosette- shaped. It has an undulating margin and its branching is dichotomous.

Its middle part is thickened to form the midrib. It is fixed to the substratum by unicellular rhizoids and multicellular scales. Examine and make a labelled drawing of gametophyte. On the dorsal side note the sporangia which appear as black dots. Examine a vertical section in the thallus and notice that it is composed of two types of tissues:

- 1- An upper assimilating tissue which consists of assimilating filaments rich in chloroplast and separated by air cavities. The upper most layer of cells is devoid of chloroplasts and forms a sort of discontinuous epidermis.
- 2- A lower storage tissue which consists of few layers of large cells devoid of chloroplasts and rich with reserve food materials.
- 3- Examine the sex organs (archegonia and antheridia) in the basal part of the air canal. Examine the sporophyte or sporangium and notice its simple structure, it is composed of a sac surrounded by a sterile wall enclosing a fertile tissue known as sporogenous tissue. The inside sporogenous tissue is formed of a large number of spore mother cells, each of which produces a spore tetrad. Notice also that the wall

of the archegonium remains attached to the sporophyte and known as calyptra.

تحت مملكة النباتات الجنينية

النباتات الحزازية

1- الحزازيات المنبثقة

الريشيا

ارسم الشكل الخارجي للثالوس (الطور الجاميتي) ولاحظ أنه مفلطح ودائري، ويتفرع تفرعا ثنائيا ويتصل بالتربة بأشباه الجذور وبحراشيف. خذ قطاعا عرضيا لدراسة التركيب الداخلي للنبات ولاحظ أن الجزء العلوي يعرف بالنسيج التمثيلي ويتكون من خيوط تمثيلية والجزء السفلي يعرف بالنسيج التخزيني ويتكون من خلايا برانشيمية. وفي نهاية بعض القنوات الهوائية عند قواعد الخيوط التمثيلية تحقق من وجود الارشونيات والانثريدات.

النبات الجرثومي يتواجد علي هيئة كرتذات جدار عقيم بداخله رباعيات جرثومية ومحاط بالجدار الارشيجوني.

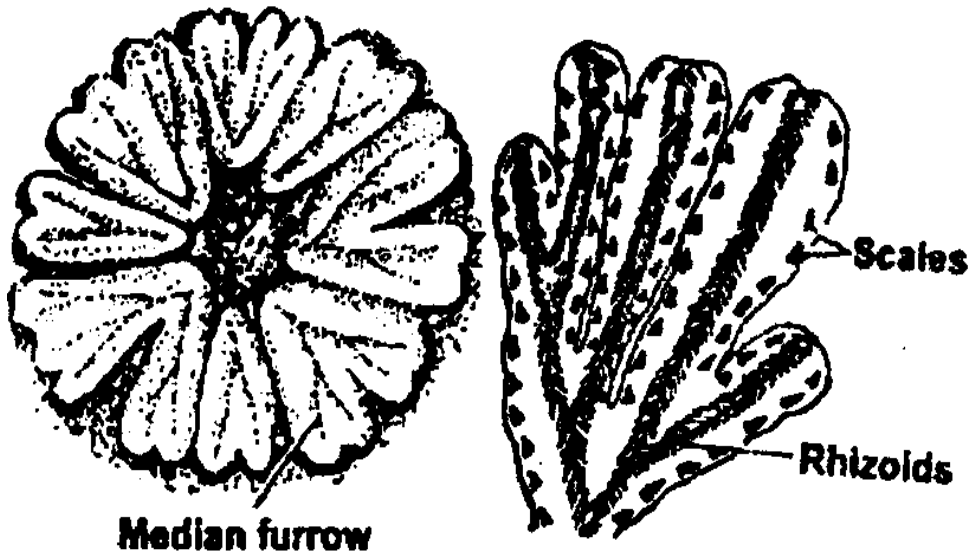

Riccia gametophyte الطور الجاميتي للريشيا

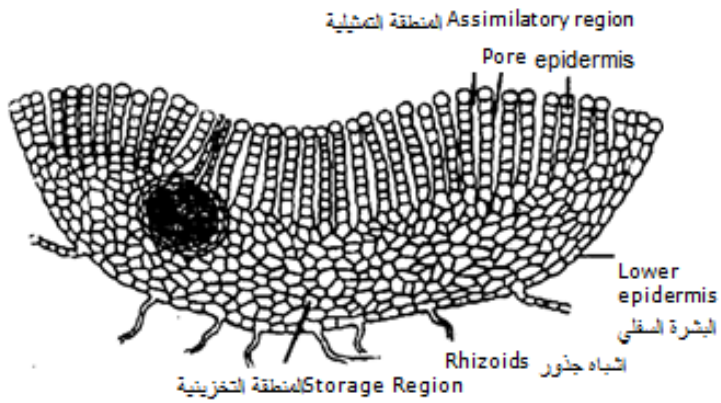

Internal section of *Riccia*
 قطاع في الطور الجاميتي للريشيا

2- Mosci (mosses)

Funaria:

It is a unisexual (dioecious) moss in which the gametophyte is composed of an upright stem that carries spirally arranged simple sessile leaves. It is fixed to the substratum by branched multicellular rhizoids.

Sketch the gametophyte

Examine a vertical section in the male moss flower and notice that it is composed of the involucre surrounding the antheridia (club-shaped, brownish or golden in color) and the paraphysis (composed of single row of cells).

Examine a vertical section in the female moss flower and notice the involucre, archegonia and paraphysis that end with acute tips.

Examine the sporophyte that is carried on the gametophyte and notice that it is differentiated into a foot which remains embedded in the tissues of the gametophyte, a long stalk or seta and the capsule. Also notice that the wall of the archegonium (clyptra) remains attached to the capsule.

Examine a longitudinal section (L.S.) in the capsule and notice its multi-layered wall, the assimilating tissue known as apophysis, at its base, the barrel-shaped sporogenous tissue, the columella, the air cavities traversed by the assimilating filaments or trabeculae, the annulus, the peristome teeth and the operculum or lid.

2- الحزازيات القائمة

الفيوناريا

ارسم الطور الجاميتي الورقي وهو يتميز إلي ساق قائمة وأوراق مرتبة ترتيبا لولبيا, وعلي قاعدة الساق أشباه جذور متعددة الخلايا. لاحظ ان الاعضاء الجنسية تتجمع عند طرف الساق في تركيب يشبه الزهرة يحيط به قلافة, بمساعدة أبرتي تشريح افصل اوراق القلافة واختبر قمة الساق تحت الميكروسكوب.

- (1) **الزهرة الحزازية المذكرة:** بها انثريدات صولجانية الشكل ذات اعناق قصيرة وتنتشر بينها خيوط عقيمة تنتهي بخلايا منتفخة.
- (2) **الزهرة الحزازية المؤنثة:** بها ارشيجونيات معنقة بينها خيوط عقيمة متعددة الخلايا غير ان خلاياها الطرفية غير منتفخة.
- (3) **النبات الجرثومي:** يتكثف علي ساق نبات جاميتي انثوي, والاول يتميز خارجيا الي قدم و عنق وعلبة وغالبا ما تكون محاطة بالجدار الرشيجوني, وللعلبة منطقة تعرف بالابوفيسيس, وتوجد عند اتصال العنق بالعلبة. كما يوجد عند قمة العلبة غطاء تقع عند قاعدته حلقة وتقع تحت الغطاء مباشرة طبقة من أسنان منفصلة تعرف بالاسنان البيروستومية.

التركيب الداخلي للعلبة

- أ- النسيج الجرثومي: ويوجد علي هيئة اسطوانة مفتوحة الطرفين.
- ب- طبقتان عدائيتان: وهما خارج وداخل اسطوانة النسيج الجرثومي
- ت- العويميد: ويوجد داخل الاسطوانة الجرثومية.
- ث- فراغ هوائي به خيوط خلوية تصل ما بين الاسطوانة الجرثومية وجدار العلبة.

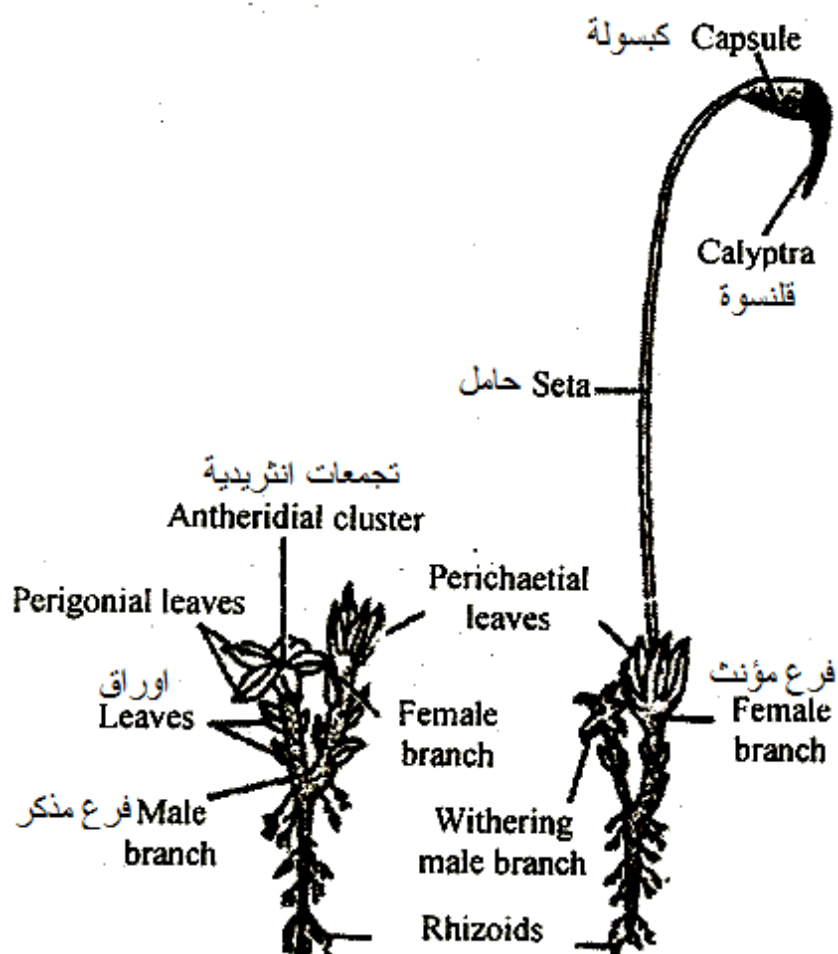

طور مشيجي حديث يحمل الاعضاء الجنسية
young gametophyte bearing sex organs

طور مشيجي يحمل الطور الجرثومي علي فرع مؤنث
Gametophyte with attached to sporophyte
on the female branch

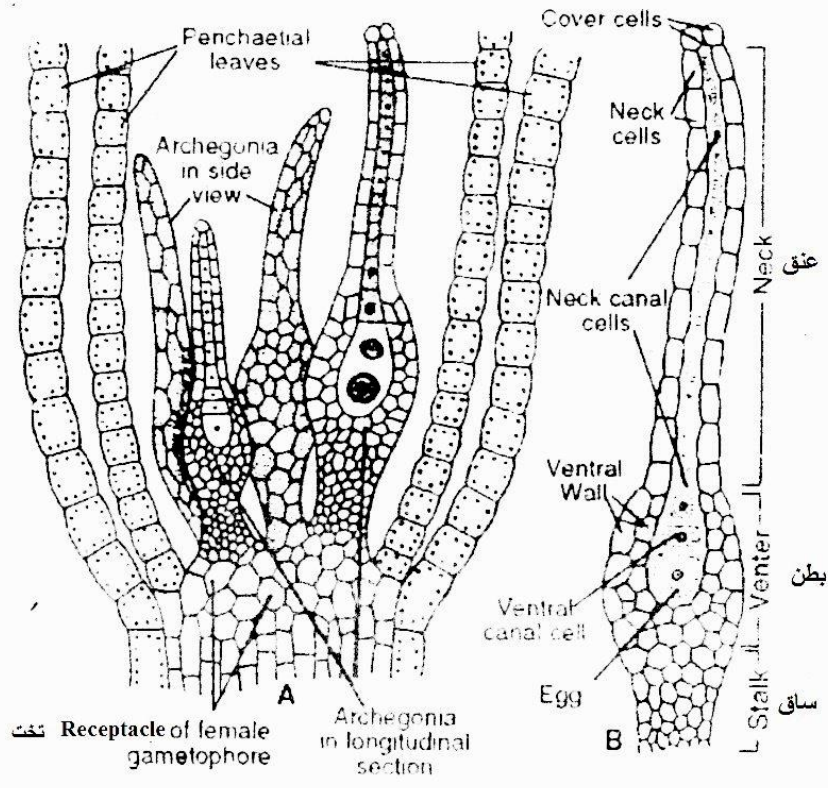
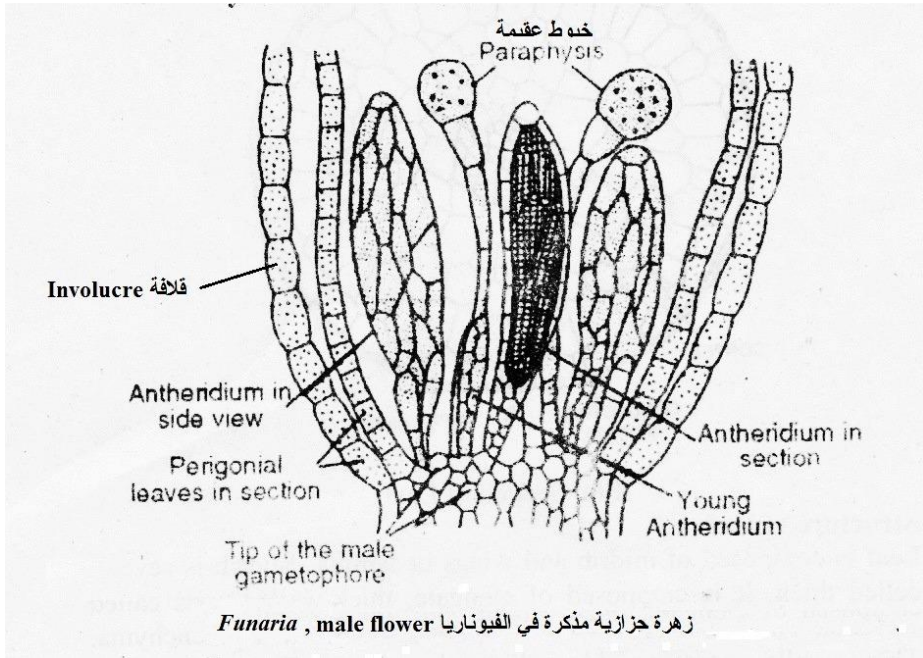

Funaria, female flower زهرة حزازية مؤنثة في الفيوناريا

D- Gymnosperms

Pinus

Examine and draw a portion of the *Pinus* stem provided. Note the scale leaves each bearing in its axial a dwarf shoot carrying few scale leaves and acicular (foliage) leaves.

Examine and notice that the female cone occur solitary and each replaces a long branch. Examine L.S. in the young female cone and notice the main axis bearing spirally arranged macrosporophylls (carpels). Each carpels is distinguished into an upper part known as the ovuliferous scale and lower part known as the bract scale, the ovuliferous scale bears on its upper surface two inverted ovule.

Examine the male cones of *Pinus* and note that they are in clusters and occupy the position of dwarf shoots. Dissect a male cone and note each microsporophyll (or staminal leaf) bears on its lower side two microsporangia (or pollen sacs) containing a number of microspores (or pollen grains). Each grain has its outer coat expanded into air bladders.

In the slide provided, which shows a longitudinal section through the male cone, note that the short stalked staminal leaves are spirally arranged on the axis and below a microsporangium is observed.

النباتات معراة البذور

الصنوبر

ادرس الشكل الخارجي لفرع شجرة نبات الصنوبر ولاحظ وجود أوراق ابرية الشكل توجد علي فروع قصيرة تسمى بالسوق القزمية, وهي تخرج من إباط أوراق حرشفية موجوده علي الساق الاصلية ويحمل الفرع نوعين من المخاريط, مخاريط صغيرة في مجاميع تأخذ مواضع السوق القزمية هي المخاريط المذكرة, ومخاريط كبيرة مفردة تأخذ موضع أحد الفروع الجانبية وهي المخاريط الانثوية.

تركيب المخروط المذكر

افحص القطاع الطولي, ولاحظ ان الاوراق الجرثومية الصغيرة تحمل أعلى محور المخروط في ترتيب لولبي, والاوراق الجرثومية الصغيرة يطلق عليها أيضا حراشيف سدائية وتتكون الواحدة منها من عنق ينتهي بطرف منتفخ يحمل علي سطحه السفلي كيسين لقاحيين يوجد بداخلهما الجراثيم الصغيرة أي احبوب اللقاح ولكل حبه جناحان يعملان علي مساعدتها في الانتشار بواسطة الرياح.

تركيب المخروط المؤنث

افحص القطاع الطولي ولاحظ أن الاوراق الجرثومية الكبيرة مرتبة في تركيب لولبي علي محور المخروط ويطلق عليها أيضا كرابل, وتتميز كل إلي حرشفة كبيرة علوية تعرف بالحرشفة البويضية واخري صغيرة تقع بأسفلها وتعرف بالحرشفة القنابية وتحمل الاولي بويضتين وبكل منها نقيير يتجه نحو محور المخروط.

ادرس النموذج الناضج للمخروط المؤنث ولاحظ أنه متخشب كبير الحجم كما انه يوجد علي الحرشفة البويضية بذرتان, ولكل منها جناح مستمد من السطح العلوي للحرشفة البويضية.

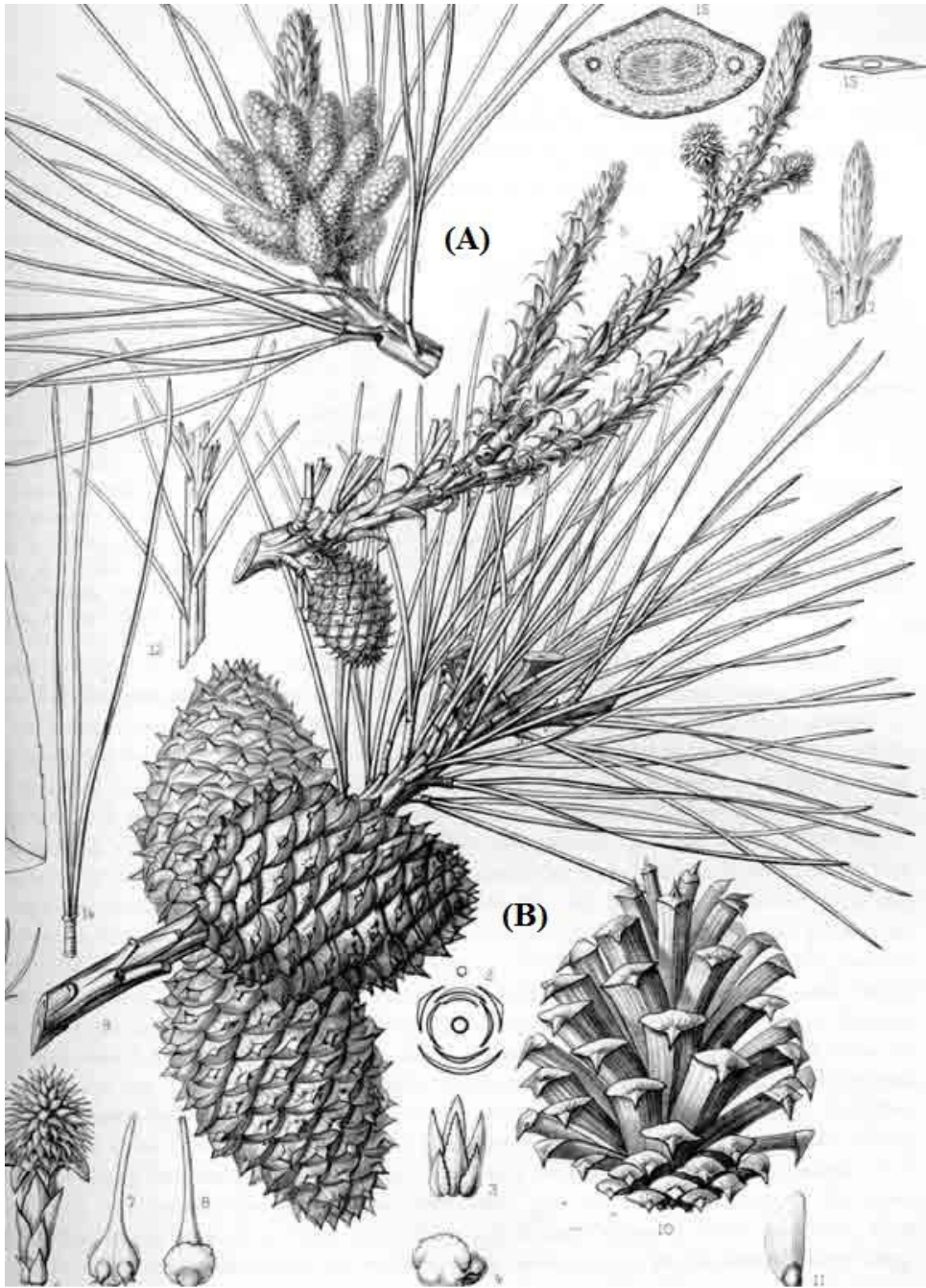

(A): Cluster of male cones of *Pinus*. (B): Abranch bearing female cones of *Pinus*.
 مجموعة مخاريط مذكرة
 فرع حامل مخاريط مؤنثة للصنوبر

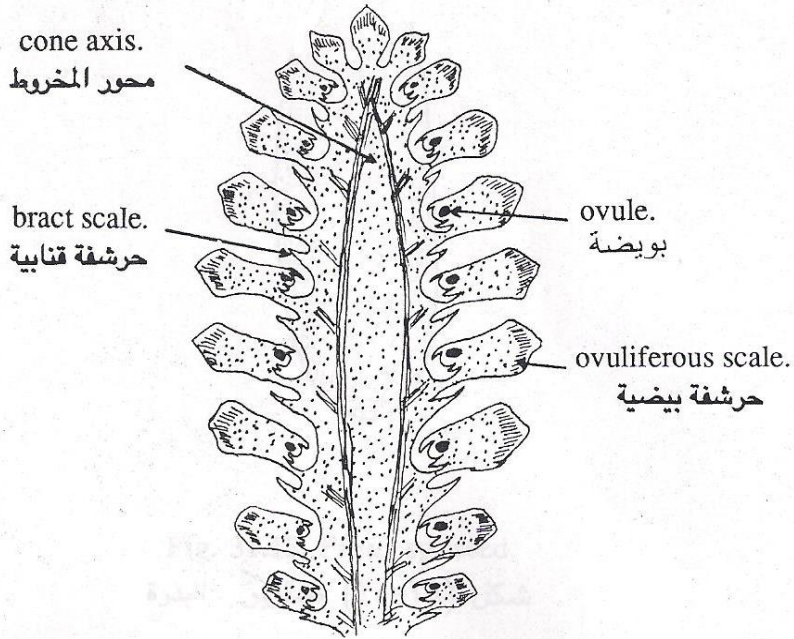

Pinus sp. L.S. female cone.

قطاع طولى فى مخروط مؤنث

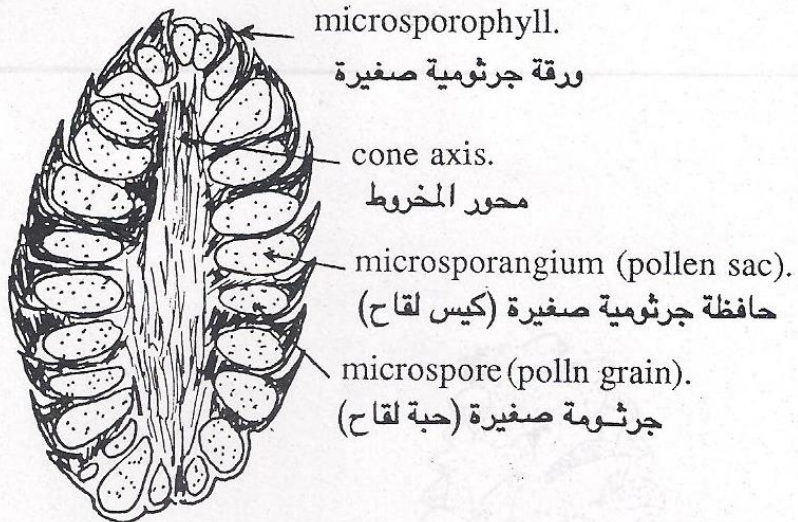

Pinus sp. L.S. male cone.

صنوبر . قطاع طولى فى المخروط المذكر

المراجع

- 1- أحمد فؤاد عفيفي وآخرون (1999): أطلس النبات. دار المعارف, مصر.
- 2- محمد محجوب عزوز وآخرون (2015): أساسيات البيولوجيا العملية. مكتبة المتنبّي, الدمام, السعودية.

3- <https://en.wikipedia.org/wiki/>